



# BARRET®

ATTREZZATURE PER L'ALLENAMENTO DEI CAMPIONI  
TRAINING TOOLS FOR CHAMPIONS



catalogo  
2020-2021  
brochure

## INDICE ALFABETICO

Archi di precisione - Precision Arcs .....	pag. 45
Arredi spogliatoio ed infermeria - Locker and infirmary room .....	pag. 161-166
Arti Marziali, Boxe - Martial Arts, Boxing .....	pag. 208-210
Atletica - Track and Field .....	pag. 220-223
Attrezzi speciali, Scalette e Bande elastiche - Special Training tools, Speed Ladders and Elastic Bands .....	pag. 69-85
Badminton.....	pag. 205
Bandierine e accessori per arbitro - Flags and referee's accessories .....	pag. 114-117
Barriera filtrante, Barriera con finestre - Reflex Training Device, Window Barrier.....	pag. 48
Basket.....	pag. 170-177
Beach Soccer.....	pag. 168
Beach Volley .....	pag. 186-187
Borse - Bags.....	pag. 130-131
Casacche, Pantaloncini, Calze, Giacche Antipioggia, Tubolare Barret .....	pag. 95-97
Ceste Portapalloni - Baskets for balls .....	pag. 129
Cross Training, Reti con bersagli - Cross Training, Nets with targets.....	pag. 146-147
Delimitatori e Birilli - Markers and Cones .....	pag. 27-31
Deviatori di traiettoria, Ball Playning - Deviators, Ball Playning .....	pag. 58-60
Fitness Equipment.....	pag. 87-94
Forche - Heading Trellises .....	pag. 46-47
Ghiaccio, Tape, Creme, Oli - Ice, Tape, Creams, Oils.....	pag. 110-111
Ginnastica - Gymnastic.....	pag. 215-219
Hockey, Baseball .....	pag. 206-207
Impianti Multifunzione - Multi purpose systems.....	pag. 185
Kit Calcio Tennis - Soccer Tennis kits.....	pag. 42-44
Kit tecnico Scuola Calcio - Soccer School kit.....	pag. 86
Lavagne Tattiche - Tactical Boards.....	pag. 106-109
Materassi, Protezioni Murarie - Mats, Wall Protections .....	pag. 211-213
Materassini, Borracce - Mats, Water Bottles .....	pag. 105;112-113
Minivolley, Superminivolley .....	pag. 184
Muri e Telai con rete - Rebounders and Iron Frames with net .....	pag. 49-57
Numerazioni Termosaldabili.....	pag. 104
Ostacoli ad altezza fissa e regolabile - Hurdles fixed and adjustable heights.....	pag. 32-41
Paletti Slalom - Slalom Poles.....	pag. 24-26
Pallamano - Handball.....	pag. 190
Palle Mediche, Ritmiche e Psicomotorie - Medicine, Rhythmic and Gym Balls.....	pag. 126-128
Palloni in pelle ed in gomma - Leather and rubber Balls .....	pag. 122-125
Panchine Allenatori - Trainers' Dug-outs.....	pag. 148-154
Parastinchi, Fasce Capitano, Guanti Portiere - Shinguards, Captain Armbands, GK Gloves .....	pag. 102-103
Pilates, Didattica Scolastica, Pattini e Skateboard - Pilates, School Products, Skates .....	pag. 224-227
Piscina, Pallanuoto - Swimming Pool, Waterpolo .....	pag. 202-204
Pompe, Compressore, Cronometri e Rotelle Metriche - Pumps, Inflator, Chronometers, Measuring Tapes .....	pag. 120-121
Porte regolamentari, ridotte, miniporte, porte bifrontali - Official goals, reduced goals, minigoals, 2 side goals .	pag. 132-141
Protezioni personali - Protections .....	pag. 188-189
Reti di Protezione - Protection Nets.....	pag. 142
Reti regolamentari e ridotte - Nets all sizes .....	pag. 143-145
Rugby.....	pag. 200-201
Sagome e Barriere - Mannequins and Barriers .....	pag. 12-23
Sedute per gradinate e Tribune modulari per interno ed esterno - Stadium seats and Stands .....	pag. 158-160
Segnalatori manuali ed elettronici per cambio giocatori - Substitution Boards .....	pag. 118-119
Strutture instabili e Tavole Propriocettive, Plinti - Equilibrium Boards.....	pag. 61-67
Tabelloni elettronici segnapunti - Electronic scoreboards .....	pag. 191-193
Tacchetti ed accessori per scarpe, Lavascarpe - Studs and shoe accessories, Shoe Washing Device.....	pag. 98-101
Tavoli calcetto - Soccer tables .....	pag. 169
Tennis Tavolo - Table Tennis .....	pag. 197-199
Tennis, Beach Tennis .....	pag. 194-196
Trampolini - Trampolines .....	pag. 68
Tunnel uscita spogliatoi - Stadium Tunnels.....	pag. 167
Vernice Segnacampo, Carrelli Traccialinee - Ecological Paint, Line Markers.....	pag. 155-157
Volley .....	pag. 178-183





## *Barret Srl*

Dal 1989 Barret Srl produce attrezzature tecniche per lo sport.

In particolare, l'Azienda si è affermata nel corso degli anni per la ideazione e realizzazione di strumenti di allenamento ormai divenuti indispensabili per la preparazione fisica, tecnica e tattica dei giocatori di Calcio, così come per la preparazione degli atleti di molti altri sport, sia di squadra che individuali.

Barret offre la più ampia varietà di attrezzature quali ad esempio sagome, ostacoli, delimitatori, birilli, paletti per slalom, archi di precisione, kit per Calcio-Tennis, forche, bande elastiche, slitte, plinti, tavolette propriocettive, telai con rete, muri in vetroresina, miniporte, porte bifrontali, ridotte e regolamentari.

La qualità che distingue i prodotti offerti e le numerose innovazioni proposte con continuità nel corso degli anni hanno permesso all'Azienda di affermarsi non solo sul mercato italiano, ma anche su quello internazionale.

Barret ha sviluppato nel tempo una preziosa collaborazione con Milan ed Inter, fondamentale per permettere un interscambio di idee ed informazioni con i preparatori atletici della prima squadra e del settore giovanile, finalizzato al continuo miglioramento della funzionalità delle attrezzature tecniche per l'allenamento.

**I prodotti Barret, infatti, vengono utilizzati quotidianamente sui campi di allenamento di Milanello e di Appiano Gentile per coadiuvare la preparazione fisica e tecnica di alcuni tra i migliori giocatori di Calcio del mondo.**

Sarebbe impresa ardua ricordare tutti i Club nazionali ed internazionali e le Nazionali che hanno scelto più volte di acquistare le nostre attrezzature attraverso la rete distributiva italiana ed estera.

Cogliamo l'occasione per ringraziare i preparatori atletici ed i responsabili acquisti di Milan, Inter, Juventus, Roma, Lazio, Napoli, Sampdoria, Fiorentina, Palermo, Torino, Empoli, Cagliari, Bologna, Sassuolo, Spal, Barcellona, Real Madrid, Bayern Monaco, Arsenal, Chelsea, Manchester City, Zenit e delle Nazionali di Calcio di Italia, Germania, Inghilterra, Francia, Spagna e Russia

### *Company Profile*

*Founded in 1989, Barret Srl gained a foothold in the international football training equipment market by creating innovative tools which have become more and more essential during training sessions of pro athletes worldwide*

*Barret manufactures products such as mannequins, hurdles, markers, cones, slalom poles, shooting arcs, soccer-tennis kits, heading trellises, all kinds of fiberglass and net rebounders, sledges, vaulting boxes, equilibrium boards, any size goals and mini goals.*

*The quality and variety of products introduced over the years make Barret the go to company when training camp is about to start.*

*Barret has a long history of working together with AC Milan and FC Internazionale Milano, two of the most prestigious Clubs in football history : all the inputs and feedbacks received by their coaches always pushes Barret to shape and improve new products*

*As a matter of fact Barret tools are used everyday at Appiano Gentile and Milanello Training Centers in order to constantly enhance AC Milan and FC Internazionale players' athletic and technical performances.*

*It would be nearly impossible to name all professional Football Clubs and National Teams that have chosen to purchase Barret products through our distribution network.*

*However we would like to take this opportunity to thank Clubs such as Milan, Inter, Juventus, Roma, Lazio, Napoli, Sampdoria, Fiorentina, Palermo, Torino, Empoli, Cagliari, Bologna, Sassuolo, Spal, Barcellona, Real Madrid, Bayern Monaco, Arsenal, Chelsea, Manchester City, Zenit and the Italian, English, German, Spanish, French and Russian National Teams.*

# **BARRET®**

Le materie prime (i vari preparati plastici ed i profilati in polipropilene copolimero ed in PVC nei vari diametri, spessori e colori) utilizzate da BARRET per lo stampaggio e l'assemblaggio degli articoli in materiale plastico sono certificate dai nostri fornitori nel rispetto delle normative vigenti che impediscono l'utilizzo di sostanze ritenute tossiche per la salute dell'uomo e dell'ambiente.

*Barret manufactures plastic products in PVC and polypropylene such as dummies, cones, markers, hurdles, slalom poles etc. using only certified non toxic raw materials not dangerous for human beings and the environment.*





**Centro Sportivo Milanello - Allenamento 07/05/2019 - Training session 07/05/2019**



**Centro Sportivo Milanello - Allenamento 09/04/2019 - Training session 09/04/2019**



**Centro Sportivo Milanello - Allenamento  
07/05/2019 - Training session 07/05/2019**



**Centro Sportivo Milanello - Allenamento  
09/04/2019 - Training session 09/04/2019**





**Allenamento 07/02/2019 - Training session 07/02/2019**



**Allenamento 28/09/2018 - Training session 24/09/2018**





**Allenamento 12/03/2019 - Training session 12/03/2019**



**Allenamento 12/03/2019 - Training session 12/03/2019**





Pag. 50

**Art. 5012SC**

**Muro per allenamento portieri in vetroresina cm. 200x130 installato su carrello in acciaio zincato con ruote**

Fiberglass Goalkeeper rebounder 200x130 cm. installed on a galvanized steel trolley with wheels

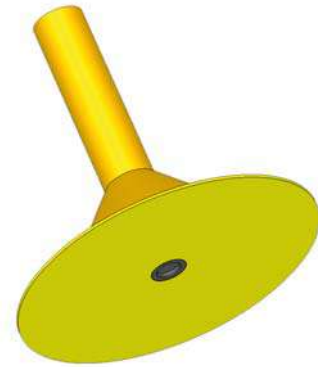

**Art. SP202**

**Base ad imbuto in plastica riempibile con sabbia, solo per paletto Ø 32 mm senza puntale**

Funnel-shaped plastic base to be filled with sand, only for pole without metal spike

Pag. 26

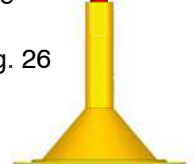

Pag. 50

**Art. PVLSC**

**Pannello in vetroresina con superficie superiore a semisfere e superficie inferiore liscia, munito di ganci e staffa per ancoraggio - dimensioni cm. 200x130**

**Può essere acquistato separatamente ed installato facilmente sulla Barriera Filtrante Reflex Art. 003RX oppure sulla Barriera con Finestre Art. 003WB**

Fiberglass panel with upper hemisphere surface and lower smooth surface, equipped with hooks and anchor bracket - size 200x130 cm. It can be purchased separately and easily installed both on the Reflex Filtering Barrier Art. 003RX and on the Window Barrier Art. 003WB

**Art. S111P**

**Kit paletto PVC Ø 32 mm senza puntale**

**Art. 007SP**

**+ base Art. SP202**

**Kit pole without metal spike**

**+ base Art. SP202**

Pag. 14



**NCP3S**

**Carrello porta 3 sagome in acciaio zincato con ruote**

**Trolley for carrying 3 Mannequins in galvanized steel, with wheels**



**3 x Art. 001 + Art. NCP3S**



Pag. 72



**Art. SQ15**

**15 SQUARES - Telaio di cm. 300x200 in alluminio regolabile in altezza munito di 6 elastici con velcro che formano 15 quadri per esercizi di coordinazione, reattività, riscaldamento e potenziamento muscolare**

Aluminium frame 300x200 cm. with adjustable heights equipped with 6 elastic bands with velcro forming 15 squares for warm up, coordination, reactivity and jumping exercises

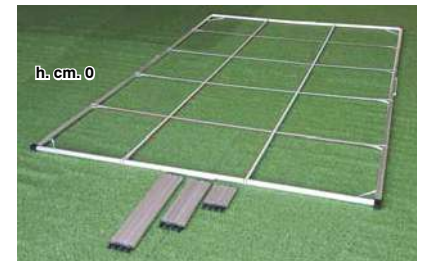

Pag. 47

**Art. ACTP40**

**Attrezzo per l'allenamento al colpo di testa applicabile a porte di qualsiasi tipo per mezzo di fettucce elastiche, in PVC Ø mm. 40 (pallone escluso)**

Header training tool to be easily applied to goals of any type by means of elastic tapes, PVC pipe Ø 40 mm. (ball not included)



**Art. 50.220**

**Telaio con rete cm. 220 x 180 in ferro zincato ad inclinazione regolabile, per allenamento portieri e giocatori**

Iron frame with net in galvanized iron dimensions 220x180 cm. adjustable inclination for goalkeepers and players

Pag. 57



## NUOVI PRODOTTI - NEW PRODUCTS



**Art. 05021456**

### JUMP-TRAINER

Strumento di allenamento per migliorare la potenza nel salto.

Adatto a portieri e giocatori

Training tool to improve jump power. For goalkeepers and field players

Pag. 83



**Art. 05021320**

### GOALKEEPER TRACTION BELT Cintura con elastici intercambiabili con 8 diversi tipi di resistenza per allenamento del portiere

Belt with elastics for goalkeeper training

8 different combinations for low, medium, medium-high, high resistance

Pag. 83

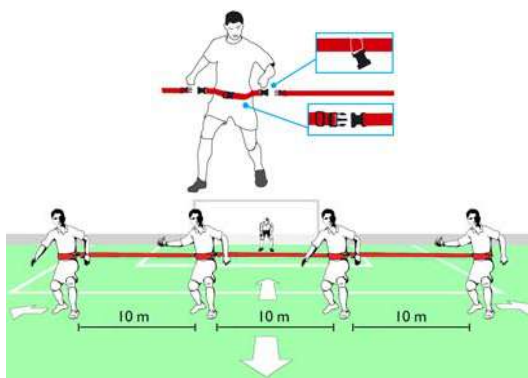

**Art. 05020798**

### Set di 4 cinture e 3 fasce non elastiche di lunghezza m. 10 ciascuna per l'allenamento dei difensori

Set of 4 hip belts with fasteners and 3 unelastic bands 10 m. long each for training defenders

Pag. 85

### Art. 05030425 Set 25 fogli adesivi cm.60x80 applicabili a porte e pareti, rimovibili e cancellabili

Set of 25 adhesive sheets 60x80 cm. printed with football-pitch

Pag. 107



**Art. 05020785**

Set bande elastiche per allenamento ai tiri di precisione da applicare a porta regolamentare, completo di borsa  
Straps for flexible marking of target zones for official size goal

Pag. 147

## NUOVI PRODOTTI - NEW PRODUCTS



### Art. KER-IS

Set 5 elastici con 5 diverse resistenze dotati di ganci metallici da entrambi i lati. Completo di 1 coppia di maniglie, 1 coppia di cavigliere, 1 accessorio per bloccare l'elastico contro una porta e utilizzare un arto per volta, 1 sacca

Set of 5 elastic bands with 5 different resistances equipped with metal hooks on both sides. Complete with 1 pair of handles, 1 pair of ankle bands, 1 accessory to lock the elastic against a door and use one limb at a time, 1 bag

Pag. 79



Pag. 73

### Art. AHF-102

Corda per salto veloce in acciaio con manici in plastica e cuscinetti a sfera (lunghezza regolabile)

Steel Skipping Rope with plastic handles and ball bearings (adjustable length)



Pag. 126

Art. PTI.M2 / ... / PTI.M10  
Palle Mediche con maniglie  
kg. 2 - 4 - 6 - 8 - 10  
Medicine Balls with handles



Pag. 76

Art. TBB2 / ... / TBB6  
Body Bar Kg. 2-3-4-5-6 per allenamento funzionale con pesi liberi  
Body Bar 2-3-4-5-6 Kg. for functional training with free weights



### Art. 991725/ ... /991728

Kit elastici allenamento pallavolo soft/medium/hard/extra hard  
Elastics for volleyball training soft/medium/hard/extra hard

Pag. 184



Pag. 74

### Art. PTI.15070

Soccer Ball Trainer completo di pallone, corda elastica di m. 12,5 e ancoraggio

Soccer Ball Trainer with ball size 5 in TPU, rubber base, 12,5 m. elastic rope, 1 peg



Art. BAL1  
Borraccia da 1 litro in alluminio  
1 liter aluminium Water Bottle



Pag. 112

Art. BAL05  
Borraccia da 1/2 litro in alluminio  
1/2 liter aluminium Water Bottle



### Art. BTA05

Borraccia termica da 1/2 litro in acciaio mantiene costante la temperatura del liquido (sia caldo che freddo)

1/2 liter thermic steel Water Bottle keeps the liquid temperature unchanged





pg.1

**NUOVO MATERIALE PIU' FLESSIBILE!!!  
NEW MORE ELASTIC PLASTIC MATERIAL!!!**



**Art. 001**  
**Sagoma Barret brevettata**  
**cm. 180 Kg. 3,5**  
Patented Barret Mannequin  
cm. 180 Kg. 3,5

**Art. 002**  
**Sagoma Barret brevettata**  
**cm. 160 Kg. 3**  
Patented Barret Mannequin  
cm. 160 Kg. 3

Colori:  
Rosso, Blu e Giallo  
Colors:  
Red, Blue and Yellow

**SAGOME BARRET BREVETTATE**  
leggere, flessibili, super-resistenti,  
antifortunistiche!  
**PATENTED BARRET MANNEQUINS**  
light, flexible, strong, safe!

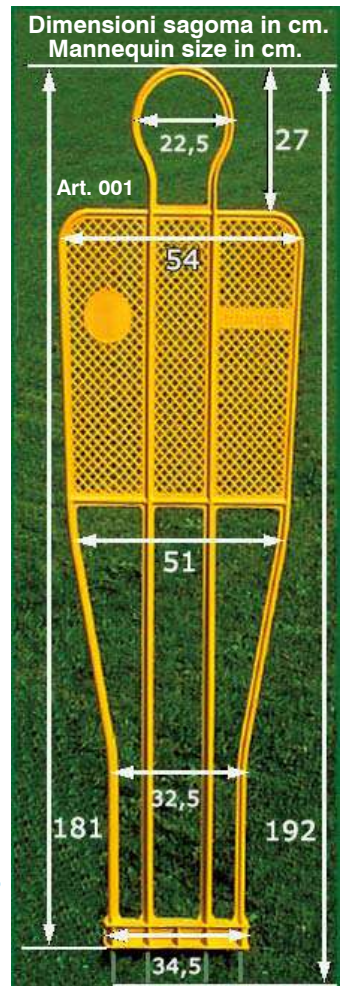



## SAGOME E BARRIERE - Barriers

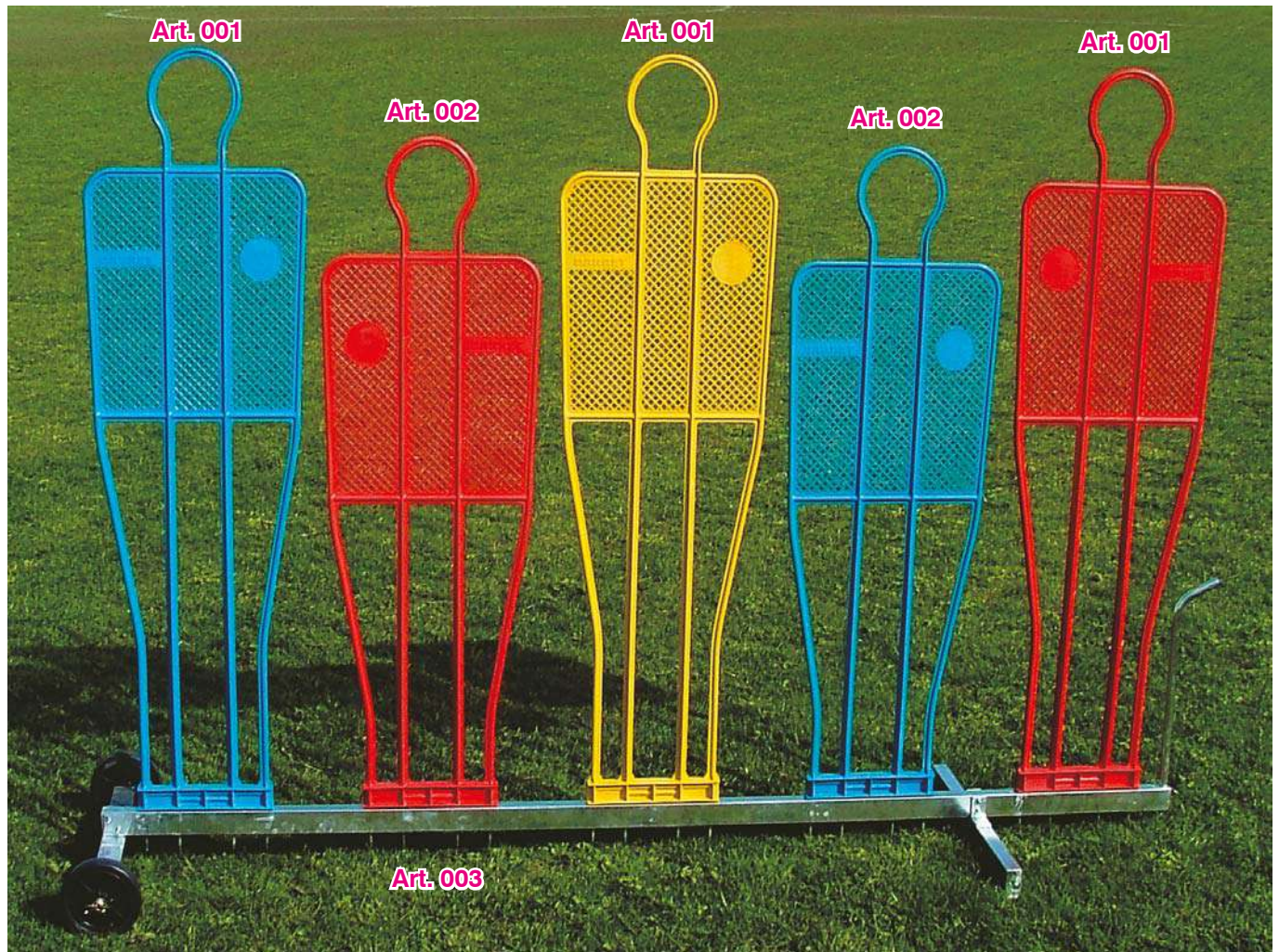

**3 x Art. 001 + 2 x Art. 002 + Art. 003**  
**Carrello con 5 sagome - trolley + 5 Barret Mannequins**

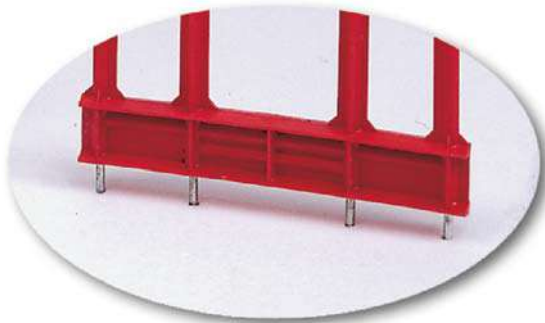

**4 puntali in acciaio zincato alla base  
per posizionamento su  
terreno naturale**

**o su carrello porta sagome**  
4 galvanized steel spikes at the base,  
for easy positioning on natural grass  
or upon Barret trolley



**Art. 003 Carrello porta 5 sagome in acciaio zincato con ruote**  
**Trolley for carrying 5 mannequins in galvanized steel, with wheels**



**SAGOME BARRET BREVETTATE**

indispensabili per:  
*calci di punizione, slalom, dribbling,  
esercizi di anticipo, uscite aeree,  
schemi tattici ...*

**PATENTED BARRET MANNEQUINS**

very useful for:  
*free kicks, slalom, dribbling, tackles,  
headers, goalkeeper exercises, tactics ...*



pg.1



**New!**







pg.1

**Art. 003RG**

**Carrello porta 5 sagome in acciaio zincato con ruote - regolabile a 4 altezze (la sagoma Art. 001 può arrivare ad un'altezza massima di cm.225)**

Trolley for 5 mannequins in galvanized steel, with wheels - 4 adjustable heights (Art. 001 can reach up to 225 cm. height)

**Il carrello regolabile in altezza permette la simulazione di giocatori in barriera che saltano al momento del calcio di punizione**  
This trolley allows free kick practicing by simulating jumping defenders



**BPS001**

**Borsa porta 5 sagome in nylon impermeabile con tracolla e maniglie, rinforzi laterali in polipropilene rigido**

Nylon carrying bag for 5 mannequins with shoulder belt and handles waterproof - reinforced on both sides





Art. 001  
+ Art. 003S

**Art. 003S Carrello porta sagoma singola con molle antiribaltamento, in acciaio zincato con ruote**

Trolley for single mannequin in galvanized steel with springs, on wheels

**Il carrello porta sagoma singola Art. 003S impedisce alla sagoma di cadere a terra se colpita dalla palla**

Trolley Art. 003S allows mannequin to come back straight up when hit by the ball



Art. 003S

pg.1

**Art. 001B Base porta sagoma zavorrabile in acciaio zincato, per posizionamento su terreni sintetici**

**Peso:**  
kg. 10 vuota,  
kg. 20 riempita con sabbia  
Galvanized steel base to be filled with sand for mannequin positioning on artificial grass.  
Weight: 10 kg. empty  
20 kg. filled with sand



Art. 001B



Art. 001  
+ Art. 001B



Art. 002R

Art. 001R

**Art. 001R Rivestimento per Sagoma cm. 180 in nylon impermeabile antistrappo con cerniera**  
**Colori: rosso, blu, giallo**  
Nylon Cover for cm. 180 Mannequin with zip  
Colors: red, blue, yellow

**Art. 002R Rivestimento per Sagoma cm. 160 in nylon impermeabile antistrappo con cerniera**  
**Colori: rosso, blu, giallo**  
Nylon Cover for cm. 160 Mannequin with zip  
Colors: red, blue, yellow



5 x Art. 001 + 5 x Art. 001R



5 x Art. 001 + 5 x Art. 001R  
+ Art. 003RG

pg.1



LATO POSTERIORE  
BACK SIDE





**Art. 001FE**  
**Sagoma Barret**  
**in acciaio zincato**  
**con 4 puntali**  
**altezza cm.180**  
**peso kg.5**  
 Barret mannequin  
 180 cm. height  
 in galvanized steel  
 with 4 spikes  
 weight 5 Kg.



**Art. 001FE**



**Art. 001FE**  
**+ Art. 001B**



**Art. 001FE**  
**+ Art. 001B**  
**+ Art. 001R**

pg.1

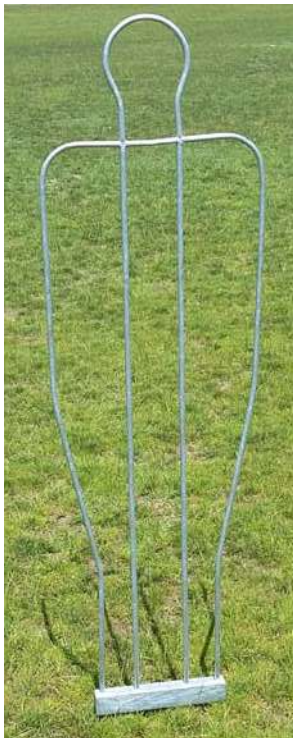

**Art. 002FE**

**Sagoma Barret in acciaio**  
**zincato con 4 puntali**  
**altezza cm.160**  
**peso kg.4,5**

Barret mannequin 160 cm.  
 height in galvanized steel  
 with 4 spikes weight 4,5 Kg.



**3 x Art. 001FE + 2 x Art. 002FE**  
**+ 2 x Art. 001R + 2 x Art. 002R**  
**+ Art. 003**





**Art. 001TD Rivestimento tridimensionale per sagoma Art. 001**  
h. cm. 180 spessore cm. 20  
in PVC monospalmato 360 gr/mq  
imbottitura in eliocell d. 16 kg/mc  
3D Cover 20 cm. thick  
for mannequin Art.001  
180 cm. height

**I rivestimenti tridimensionali simulano perfettamente il volume del corpo dei giocatori permettendo una serie di esercizi tecnici e tattici con e senza palla ancora più realistici e sicuri. L'imbottitura è inoltre utile per proteggere la sagoma dagli urti della palla calciata ad alta velocità durante gli allenamenti ai calci piazzati di potenza**



**3D Covers perfectly resemble players' bodies allowing even more realistic and safe technical and tactical exercises with and without ball. The soft sandwich protections also avoid possible damages caused by high speed power free kick practising**



pg.1

**Art. 002TD Rivestimento tridimensionale per sagoma Art.002**  
h.cm.160  
spessore cm. 20  
in PVC monospalmato 360 gr/mq  
imbottitura in eliocell d. 16 kg/mc  
3D Cover 20 cm. thick  
for mannequin Art.002  
160 cm. height





**Art. GP170**

**Sagoma in gommapiuma h. cm. 170 - rivestimento in PVC con decorazione digitale fronte-retro del giocatore, zavorrata alla base con sabbia con maniglie per il trasporto colori disponibili: rosso, blu, giallo, arancio, bianco**  
**Ø base cm. 59 - peso kg. 31**  
 Foam rubber Dummy  
 170 cm. height with PVC Cover with player's sketch  
 weighted base with sand with handles  
 available colors: red, blue, yellow, orange, white  
 base Ø 59 cm. - weight 31 kg.

**Nessun problema di forature, perdite d'aria o lacerazioni**  
 No problems with punctures, deflation or lacerations



**Rivestimento in PVC**  
 PVC Cover outside

**Imbottitura in poliuretano espanso**  
 Foam rubber inside

pg.1

**Art. GP205**

**Sagoma in gommapiuma h. cm. 205 - rivestimento in PVC con decorazione digitale fronte-retro del giocatore, zavorrata alla base con sabbia con maniglie per il trasporto colori disponibili: rosso, blu, giallo, arancio, bianco**  
**Ø base cm. 59 - peso kg. 32**  
 Foam rubber Dummy  
 205 cm. height with PVC Cover with player's sketch  
 weighted base with sand with handles  
 available colors: red, blue, yellow, orange, white  
 base Ø 59 cm. - weight 32 kg.

**Maniglia su entrambi i lati**  
 Handle on both sides

**Base zavorrata**  
 Weighted base

**Art. GP170SL**

**Sagoma in gommapiuma come Art. GP170 solo con logo BARRET (senza la decorazione del giocatore)**  
 Foam Rubber Dummy same of Art. GP170 only with BARRET logo (without player's sketch)



**Art. GP205SL**

**Sagoma in gommapiuma come Art. GP205 solo con logo BARRET (senza la decorazione del giocatore)**  
 Foam Rubber Dummy same of Art. GP205 only with BARRET logo (without player's sketch)



**NUOVO PVC/PU ANCORA PIÙ RESISTENTE  
NEW STRONGER PVC/PU**



**Art. SAG205**  
**Sagoma Gonfiabile**  
**h.cm.205**  
Inflatable dummy  
205 cm. height

pg.1



**Art. SAG175**  
**Sagoma Gonfiabile h.cm.175**  
Inflatable dummy  
175 cm. height

**Art. SAG115**  
**Sagoma Gonfiabile h.cm.115**  
Inflatable dummy 115 cm. height

**Ideale per i bambini delle scuole calcio  
best for soccer school kids**



**Ø base cm. 56 - peso kg. 23**  
**(pronta all'uso)**  
base Ø 56 cm. - weight 23 Kg.  
(when ready for use)

**Ø base cm. 45 - peso kg. 11**  
**(pronta all'uso)**  
base Ø 45 cm. - weight 11 Kg.  
(when ready for use)

**Ø base cm. 40 - peso kg. 7**  
**(pronta all'uso)**  
base Ø 40 cm. - weight 7 Kg.  
(when ready for use)

**Art. KSG Kit di riparazione per sagoma gonfiabile**  
**(n. 1 confezione di collante n. 3 porzioni di rivestimento)**  
Repairing Kit for inflatable dummies (glue and 3 patches)

**Per un ordine minimo di 100 pezzi per misura le sagome gonfiabili possono essere personalizzate**  
**Inflatable dummies can be customized: minimum order 100 pieces for each size**

**Se colpite dalla palla o dal corpo dei giocatori durante gli esercizi, le sagome gonfiabili Barret tornano in piedi da sole**

**Barret inflatable dummies always pop back up when hit by ball or players' body during exercises**

**Nate per l'allenamento dei portieri, le sagome gonfiabili Barret possono essere utilizzate anche per i calciatori per l'effettuazione di una molteplicità di esercizi tecnici e tattici con e senza palla**

**Born for GK training, Barret inflatable dummies are very useful for lots of tactical and technical exercises involving players with and without ball**



**Particolare della valvola superiore (rientrante) da utilizzare per la gonfiatura della sagoma e della valvola inferiore (anch'essa rientrante) da utilizzare per il riempimento della base di appoggio a terra con acqua**  
**The upper valve to inflate the body with air, the bottom valve to fill the base with water**



## ISTRUZIONI PER LA GONFIATURA E L'UTILIZZO DELLE SAGOME GONFIABILI

**IMPORTANTE: QUANDO È IN USO LA SAGOMA NON DEVE ESSERE COMPLETAMENTE GONFIA. IL CORPO DEVE RIMANERE SEMPRE MORBIDO, ED I FIANCHI NON DEVONO ESSERE MARCATAMENTE SPORGENTI VERSO L'ESTERNO RISPETTO ALLA BASE (UNA ECCESSIVA QUANTITÀ D'ARIA LOGORA LE SALDATURE ED ACCORCIA LA VITA DEL PRODOTTO)**

- 1) Gonfiare la sagoma moderatamente
- 2) Tenendo la sagoma distesa a terra, inserire acqua nel serbatoio: quando la sagoma comincia ad inclinarsi verso l'alto, chiudere il tappo del serbatoio e disporla in posizione verticale
- 3) Provare a spingere la sagoma lateralmente e osservare come torna in posizione eretta
- 4) Se si vuole che la sagoma si rialzi più velocemente, aggiungere dell'acqua (a discapito del peso) e gonfiare un po'
- 5) Se si gonfia ulteriormente la sagoma, distenderla a terra e fare uscire l'aria in eccesso dal serbatoio dell'acqua (il fondo deve essere piatto, non bombato)
- 6) E' importante **utilizzare la minima quantità di acqua** che permette alla sagoma di risalire nel modo desiderato (un peso eccessivo e non giustificato può logorare inutilmente le saldature, accorciando la vita del prodotto)
- 7) Una volta trovato l'equilibrio desiderato, la sagoma può essere sgonfiata e rigonfiata (ad esempio, per trasportarla in luogo lontano) senza più svuotare il serbatoio dell'acqua
- 8) Non utilizzare le sagome se la temperatura è più bassa di 5 °C (e in ogni caso non usarle se l'acqua nel serbatoio è ghiacciata)
- 9) Non colpire le sagome con corpi appuntiti, non avvicinarle a fonti di calore, non trascinarle ma sollevarle sempre quando occorre spostarle, non sbatterle violentemente a terra, non lasciarle esposte al sole per giorni
- 10) Per le riparazioni utilizzare l'apposito kit o Loctite 406 (altri prodotti non hanno efficacia sul materiale) Il prodotto è garantito solo per un utilizzo diligente che rispetti le istruzioni fornite



**Art. KSG**  
**Kit di riparazione**  
(collante +  
**3 porzioni di**  
**rivestimento**)  
Inflatable dummy  
repairing kit



**Sempre in piedi**  
Pop up dummies



### USER'S INSTRUCTIONS

**IMPORTANT: WHEN USING YOUR DUMMY YOU ALWAYS HAVE TO KEEP THE BODY VERY SOFT, AND HIPS HAVE TO BE IN A STRAIGHT LINE WITH THE BASE (THEY MUST NOT BE ROUNDED). AN EXCESSIVE AMOUNT OF AIR WILL WEAR OUT THE WELDS AND SHORTEN THE TOOL'S LIFE**

Inflatable dummies are entirely made of soft PVC/PU: there are no rigid parts, so these products are absolutely safe. First, you have to inflate your dummy but not completely. Then, by keeping it lying on the floor, you have to put some water in the tank: when the dummy rises up, close the valve and place it upright.

If you want your dummy to rise up more quickly when hit, add some water and inflate the body a little more. In this case, let the dummy lie on the floor for a while and let some air out from the tank (the base must be flat, not rounded). It's important you **to use the minimum amount of water** that allows your dummy to rise the desired way (an excessive and unjustified weight will wear out the welds, shortening the tool's life).

Dummies can be used both on natural and artificial grass, on turf, gym floors etc.

Two side handles made of soft PVC are very useful to carry your dummy around: it is important to always lift your dummy when you need to move it (never pull it!) so the base doesn't get scratched.

Do not use dummies if the temperature is lower than 5 °C (and in any case do not use them if the water in the tank is frozen).

It is also available a kit for repair when inflatable dummies get damaged because used in wrong ways, in example when they are torn apart by players kicking with their studs against them.





pg.1

**Art. 706244**  
**Sagoma in plastica rinforzata antiurto su carrello a 4 ruote**  
**altezza cm.190**  
**peso totale Kg.22**  
**(kg.7 la sagoma - Kg.15 il carrello)**  
**spessore sagoma cm.9**  
 Mannequin in reinforced plastic 9 cm. thick with 4 wheel trolley height 190 cm. weight 22 Kg.

**LATO ANTERIORE**  
**FRONT**

**LATO POSTERIORE**  
**BACK**

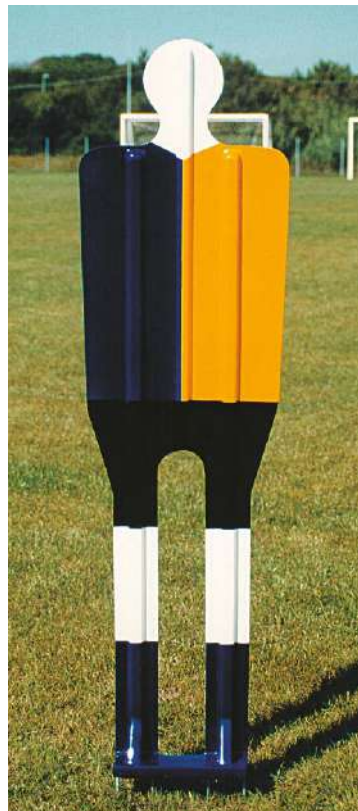

pg.1

**Art. 5026**  
**Sagoma Barret**  
**in vetroresina**  
**h. cm. 185**  
 Barret  
 fiberglass  
 Mannequin  
 185 cm. height

**Indistruttibili!**  
**Unbreakable!**

**4 puntali in acciaio zincato alla base, per posizionamento su terreno naturale o su carrello portasagome**

4 galvanized steel spikes at the base, for quick positioning on natural grass or on trolley



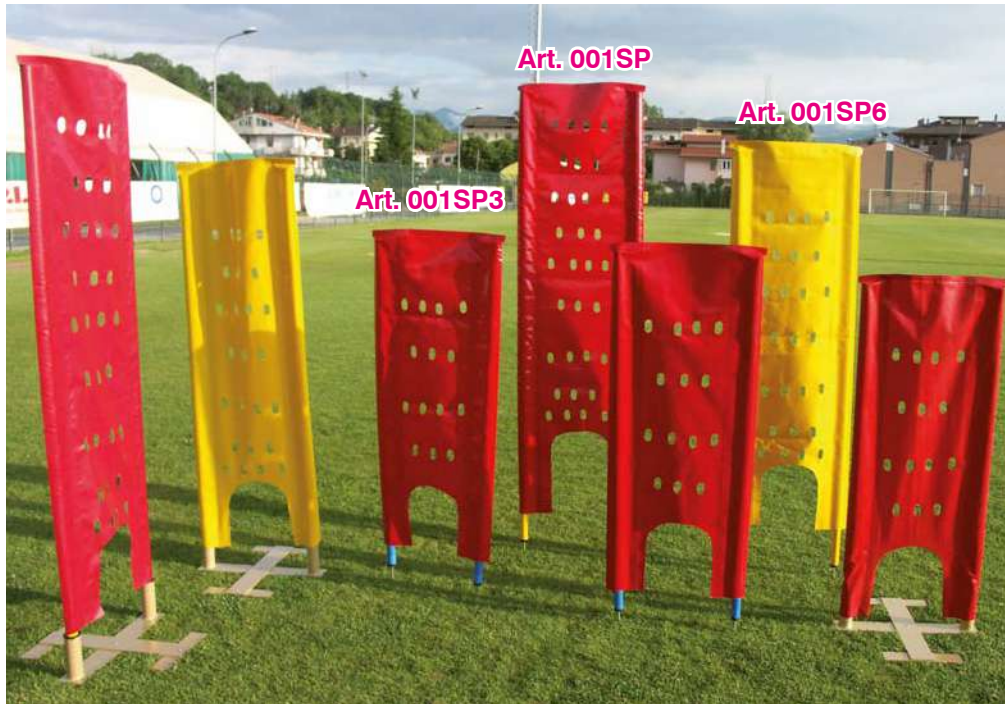

**Art. 001SP**  
**Sagoma Morbida telo PVC forato antivento con 2 Paletti in PVC h. cm. 170**  
 Soft pierced antiwind PVC Mannequin with 2 PVC Poles 170 cm. high

**Art. 001SP3**  
**Sagoma Morbida telo PVC forato antivento con 2 Paletti in PVC h. cm. 130**  
 Soft pierced antiwind PVC Mannequin with 2 PVC Poles 130 cm. high

**Art. 001SPA**  
**Sagoma Morbida telo PVC forato antivento con 2 Paletti in alluminio h. cm. 170**  
 Soft pierced antiwind PVC Mannequin with 2 aluminium Poles 170 cm. high

**Art. 001SP6**  
**Sagoma Morbida telo PVC forato antivento con 2 Paletti in PVC h. cm. 160**  
 Soft pierced antiwind PVC Mannequin with 2 PVC Poles 160 cm. high

 pg.1



**Art. SA001**  
**Supporto per sagoma morbida in ferro verniciato utilizzabile su terreno sintetico**  
 Base in painted iron for positioning any soft mannequin on artificial grass





## PALETTI SLALOM - Slalom Poles

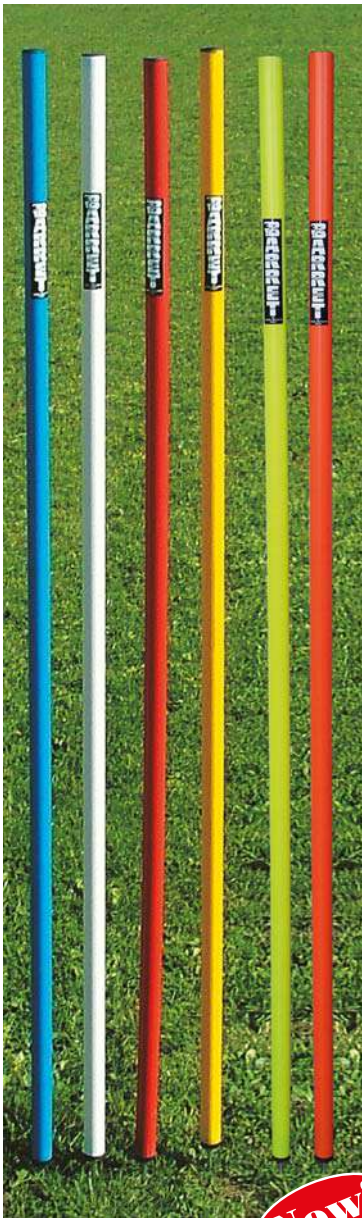

**New!**

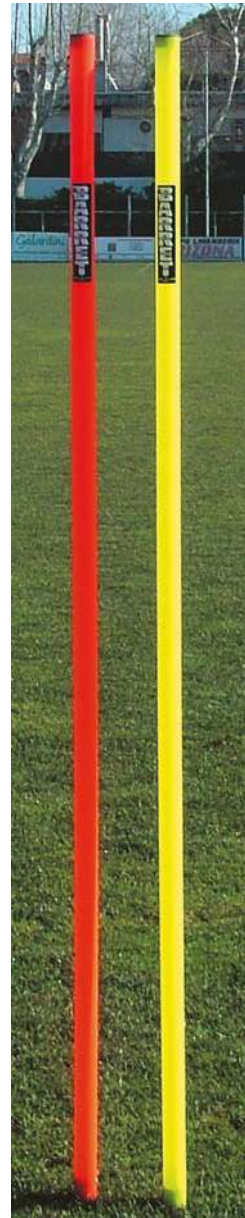

**Art. 007**  
**Paletto con puntale**  
**cm. 170 in PVC Ø mm. 32**  
**colore giallo, giallo fluo,**  
**rosso, bianco, blu,**  
**arancio**  
 Pole 170 cm. high  
 in PVC with  
 galvanized metal spike  
 colors: yellow, fluo yellow,  
 red, white, blue,  
 orange

pg.1

**Art. 007SP**  
**Paletto senza puntale**  
**cm. 162**  
**in PVC Ø mm. 32**  
**colore giallo, rosso,**  
**bianco, blu**  
 Pole 162 cm. high  
 in PVC  
 colors: yellow, red,  
 white, blue

pg.1



**Art. P007** pg.2  
**Paletto cm. 160**  
**in polipropilene**  
**Ø mm. 30 con**  
**puntale e piattello**  
**di appoggio,**  
**colore giallo**  
**o arancio**  
**fluorescente**  
 Pole 160 cm. h. in  
 polypropylene,  
 metal spike with ring  
 (colors: fluoescent  
 yellow and orange)

**Art. BFT**  
**Borsa porta paletti**  
**(capienza massima**  
**30 pezzi)**  
 Bag containing  
 30 poles



pg.2

**Art. 007F**  
**Paletto in polipropilene**  
**copolimero Ø 32 mm.**  
**h.cm.163**  
**con puntale zincato,**  
**colore giallo o arancio**  
**fluorescente**  
 Slalom Pole 163 cm. height in  
 copolymer polypropylene  
 32 mm. with galvanized metal  
 spike (colors: fluoescent  
 yellow and orange)





pg.2



**Art. A007**  
Paletto cm. 170  
in alluminio Ø mm. 32  
con puntale zincato  
Pole 170 cm. high  
in aluminium with  
galvanized metal spike



**Art. AS007**  
Paletto flessibile  
cm. 170 in  
alluminio Ø mm.  
32 con puntale  
zincato e molla  
Pole 170 cm. h.  
in aluminium with  
galvanized metal  
spike and spring



**Art. S007**  
Paletto flessibile  
cm. 170 in  
PVC Ø mm. 32 con  
puntale  
zincato e molla,  
colore giallo o rosso  
Pole 170 cm. h.  
in PVC with  
galvanized metal  
spike and spring  
colors: yellow, red



cm. 170

cm. 90



**Art. 007TL**  
Paletto telescopico  
Ø 32 mm  
h. cm. 170 in PVC  
con puntale zincato  
(l'altezza si riduce  
fino a cm.90)  
colore giallo  
Telescopic Pole 170 cm.  
h. in PVC with galvanized  
metal spike  
Height can be reduced  
down to 90 cm.  
color yellow



pg.2



**Art. 007.25**  
Paletto  
cm. 170  
smontabile  
in PVC  
Ø 25 mm  
con puntale  
zincato svitabile  
colore giallo  
Dismountable  
Pole 170 cm.  
height in PVC  
with removable  
galvanized metal  
spike  
color yellow







h. cm. 173

**Art. 010**  
Kit paletto PVC  
Ø 32 mm  
senza puntale  
Art. 007SP  
+ base Art. 018  
Kit pole without  
metal spike  
+ base Art. 018



**Art. 018**  
Base ad imbuto  
in plastica per  
paletto Ø 32 mm  
con o senza puntale  
Funnel-shaped plastic base for pole  
with or without metal spike



h. cm. 170

**Art. 010C**  
Kit paletto PVC  
Ø 32 mm  
senza puntale  
Art. 007SP  
+ base Art. 902013  
Kit pole without  
metal spike  
+ base Art. 902013



**Art. 902013**  
Base cilindrica in plastica  
riempibile con sabbia o  
acqua, solo per paletto  
Ø 32 mm senza puntale  
Cylindrical plastic base to  
be filled with sand or water,  
only for pole without  
metal spike



h. cm. 176

**Art. 010WR**  
Kit paletto PVC  
Ø 32 mm  
senza puntale  
Art. 007SP  
+ base Art. HWRB  
Kit pole without  
metal spike  
+ base Art. HWRB



**Art. SP25**  
Asta in PVC Ø 25 mm.  
altezza cm. 152  
PVC pole Ø 25 mm.  
height 152 cm.

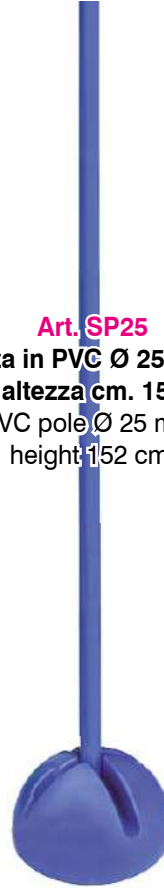

**Art. TAH-X**  
Base riempibile  
con sabbia per  
aste Ø 25 mm.  
e cerchi piatti  
o tubolari  
Base to be filled  
with sand for poles  
Ø 25 mm. and flat  
or tubular hoops



**Art. HWRB**  
Base in gomma  
appesantita  
per paletto Ø 32 mm  
con o senza puntale  
Weighted Rubber base  
for pole with  
or without metal spike

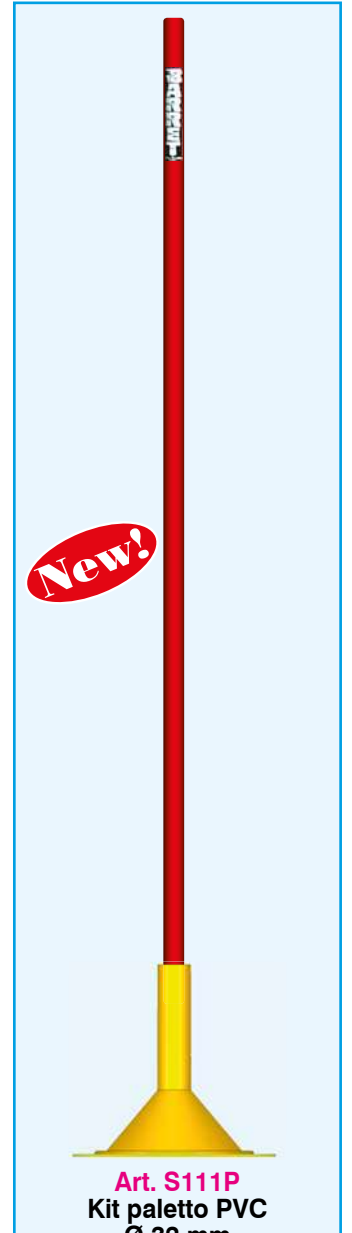

**New!**

**Art. S111P**  
Kit paletto PVC  
Ø 32 mm  
senza puntale  
Art. 007SP  
+ base Art. SP202  
Kit pole without  
metal spike  
+ base Art. SP202



**New!**

**Art. SP202**  
Base ad imbuto  
in plastica riempibile con  
sabbia, solo  
per paletto Ø 32 mm  
senza puntale  
Funnel-shaped plastic base  
to be filled with sand, only for  
pole without metal spike



## DELIMITATORI - Markers

**SPECIFICARE I COLORI RICHIESTI AL MOMENTO DELL'ORDINE**  
**PLEASE, SPECIFY COLORS IN YOUR ORDER**



### Art. 016

**Kit 48 Delimitatori h. cm.5 con rimessaggio**  
**colori disponibili:**

**giallo fluo, rosso, fucsia, arancio fluo, blu, bianco**

Kit 48 Markers h. 5 cm. with holder

(colors: fluo yellow, red, fuchsia, fluo orange, blue, white)

### Art. 016.1

**Kit 48 Delimitatori h. cm.5 senza rimessaggio**  
**(come articolo 016)**

Kit 48 Markers h. 5 cm. without holder



### Art. 016.B

**Kit 48 Delimitatori h. cm.8 con rimessaggio**  
**giallo fluo, rosso, fucsia, arancio fluo, blu, bianco**

Kit 48 Markers 8 cm. height with holder

(fluo yellow, red, fuchsia, fluo orange, blue, white)



### Art. 016.R

**Rimessaggio**  
**per delimitatori**  
**h. cm.8 e delimitatori**  
**giganti Art. 016.K**  
Iron Holder for 8 cm.  
and giant markers

pg.3



**Art. 016.R5 Rimessaggio per**  
**delimitatori h. cm.5 e cm.7**  
Iron Holder for 5 cm. and 7 cm.  
height markers



### Art. 016-TDC

**Raccoglitore in plastica per delimitatori**  
**con manico allungabile**

Adjustable length picking device for markers



### Art. 016.T



### Art. 016.T

**Kit 48 Delimitatori h. cm. 7**  
**con rimessaggio**  
**e intagli sulla sommità**  
**colori disponibili: giallo e rosso**

Kit 48 Markers with holder 7 cm. height carved on top  
(colors: red and yellow)



**Art. OSPT15** Delimitatore circolare piatto Ø cm.15 spessore mm.1 colori giallo, rosso, arancio e bianco  
Flat round Marker Ø 15 cm. colors: red, yellow, orange and white

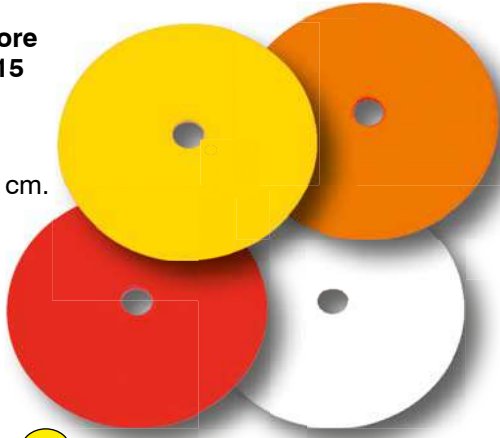

**Ideali per superfici sintetiche**  
Great for indoor and turf

pg.3

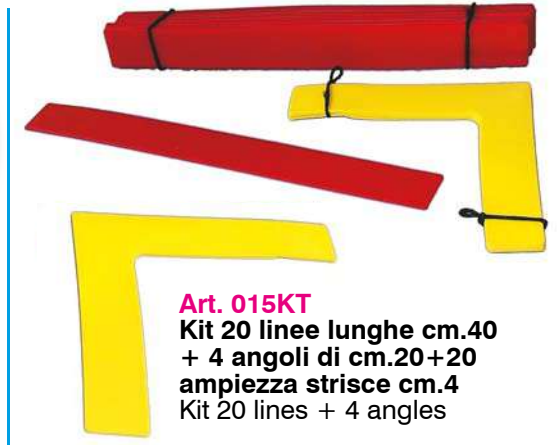

**Art. 015KT**  
Kit 20 linee lunghe cm.40 + 4 angoli di cm.20+20 ampiezza strisce cm.4  
Kit 20 lines + 4 angles

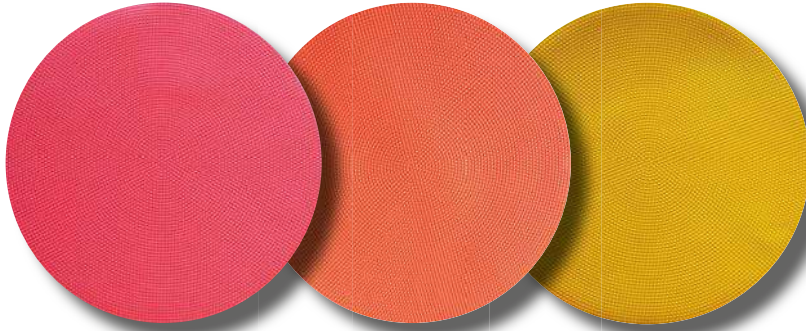

**Art. DC25**  
Delimitatore circolare piatto Ø cm.25 spessore mm.1 colori giallo, rosso, arancio  
Flat round Marker Ø 25 cm. colors: red, yellow, orange



**Art. 016.K**

pg.3

**Art. 016.K**  
Delimitatore gigante con scanalature Ø cm. 30 h. cm.15 peso gr. 100 colori: giallo, arancio e bianco  
Giant Marker 15 cm. height carved on top and sides colors yellow, orange and white



**Art. E21**

Con l'uso di traverse consente la creazione di ostacoli di altezza cm. 5 / 10 / 15  
Giant markers along with crossbars can create hurdles 5-10-15 cm. high



**Art. E21** Traversa cm.120 in PVC Ø mm. 25 - colori giallo, rosso, blu, verde, bianco  
Crossbar 120 cm. in PVC Ø 25 mm. - colors yellow, red, green, blue, white

pg.3



## BIRILLI - Cones

**Art. 205000**  
**Birillo calpestabile**  
**in caucciù termoplastico**  
**base Ø cm. 14 - h. cm. 15**  
**colori giallo e rosso**  
Soft Cone 15 cm. height  
14 cm. Ø base  
colors red and yellow



**Art. HA7**  
**Birillo calpestabile**  
**in caucciù**  
**termoplastico**  
**base Ø cm. 17**  
**h. cm. 18**  
**colori giallo e rosso**  
Soft Cone  
18 cm. height and  
17 cm. Ø base  
colors: red, yellow

pg.3



**Art. 019**

**Art. 019**  
**Kit 24 Maxidelimitatori cm. 28**  
**colori: giallo, arancio, rosso,**  
**royal e fucsia**  
Kit 24 Maximarkers, height 28 cm.  
colors: yellow, orange, red, blue  
and fuchsia

**Art. 019.1**  
**Maxidelimitatore cm. 28 singolo**  
**colori: giallo, arancio, rosso,**  
**royal e fucsia**  
Loose Maximarker height 28 cm.  
colors: yellow, orange, red, blue  
and fuchsia

pg.3

**Art. 023E**  
**Birillo economico senza fori h. cm. 30**  
**colori rosso e giallo**  
Light Cone 30 cm. height with no holes  
colors: red and yellow





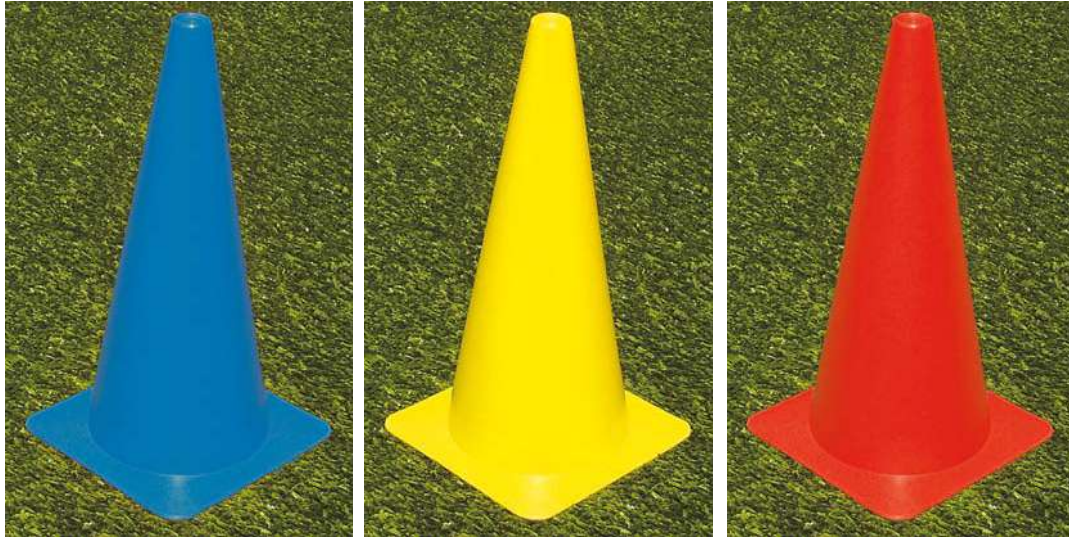

**Art. 023N**

**Birillo cm. 38 colore rosso, giallo o blu** - Cone height 38 cm. colors: red, yellow, blue

**Peso gr. 200 senza foro sulla sommità - Weight 200 gr. with no hole at top**



**Peso gr. 450  
Weight 450 gr.**

**Art. 023**

**Birillo giallo cm. 40 con foro sulla sommità**  
Yellow Cone with hole at the top

**Art. 025**

**Birillo fucsia cm. 40 con foro sulla sommità**  
Fuchsia Cone with hole at the top

**Art. 024**

**Birillo rosso cm. 40 con foro sulla sommità**  
Red Cone with hole at the top

● pg.3



**in 4 colori  
in 4 colors**

**Art. B312**

**Birillo a 8 fori h. cm. 30 con scanalatura sulla sommità**  
Cone with 8 holes 30 cm. height carved on top



**Art. E21 Traversa cm.120 in PVC Ø mm. 25**

**colori giallo, rosso, blu, verde, bianco**

**Crossbar 120 cm. in PVC Ø 25 mm. - colors yellow, red, green, blue, white**





**Art. I-111**  
**Clip rotante**  
**per aste**  
 Ø mm. 25 e 28  
 Rotating clip  
 for two pipes  
 Ø mm. 25 and 28



**Art. C21**  
**Birillo a 16 fori**  
**cm. 50 con scanalatura**  
**sulla sommità**  
**in 4 colori**  
 Cone with 16 holes  
 height 50 cm.  
 carved on top  
 in 4 colors

pg.3

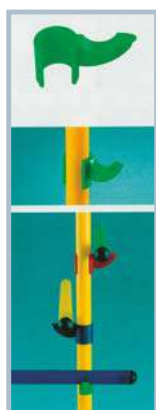

**Art. I-110**  
**Clip per montante**  
**Ø mm. 25 e 28**  
**e traversa**  
 Clip for pipe  
 Ø mm. 25 and 28  
 and crossbar

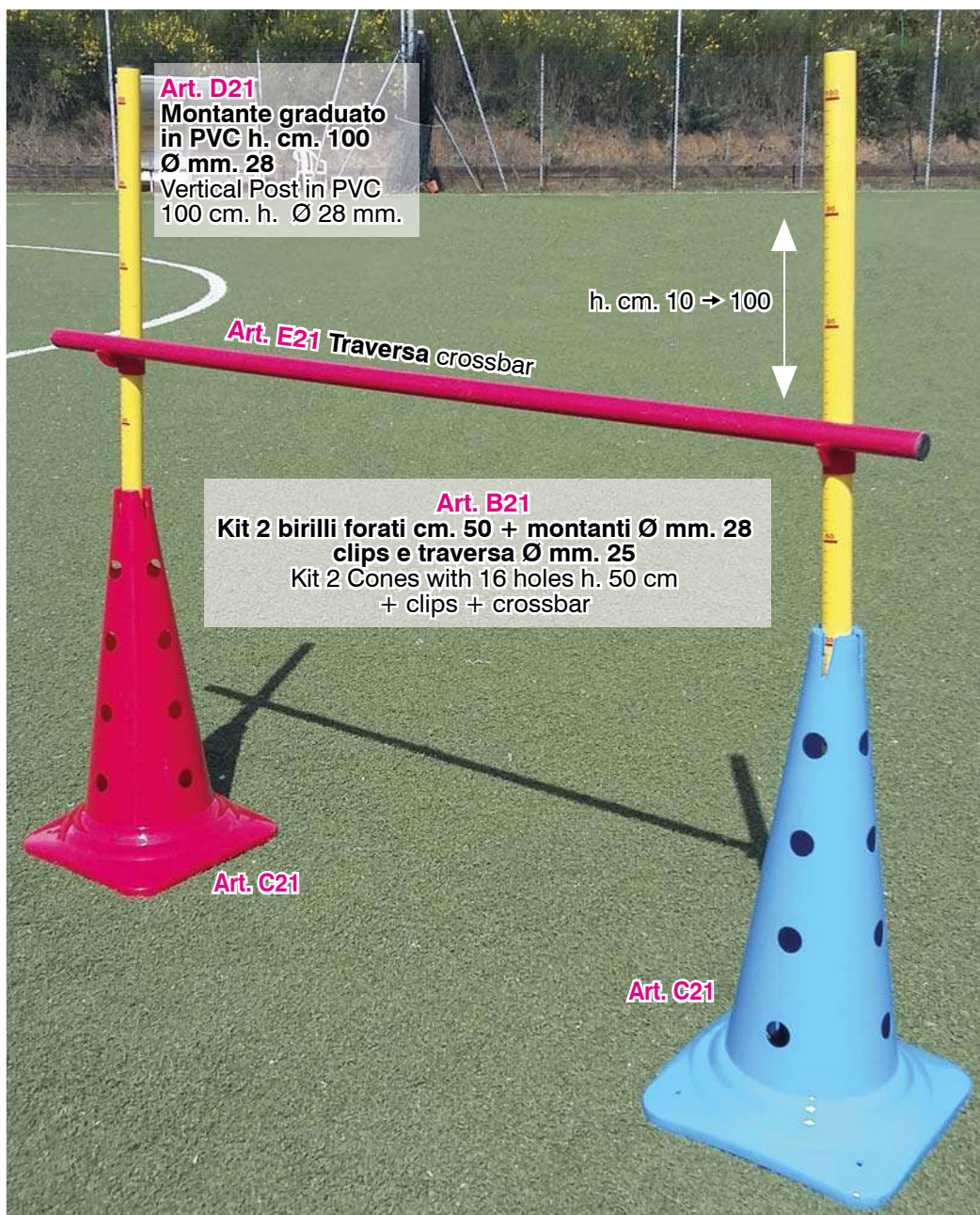

**Art. D21**  
**Montante graduato**  
**in PVC h. cm. 100**  
**Ø mm. 28**  
 Vertical Post in PVC  
 100 cm. h. Ø 28 mm.

h. cm. 10 → 100

**Art. E21** *Traversa* crossbar

**Art. B21**  
**Kit 2 birilli forati cm. 50 + montanti Ø mm. 28**  
**clips e traversa Ø mm. 25**  
 Kit 2 Cones with 16 holes h. 50 cm  
 + clips + crossbar

**Art. C21**

**Art. C21**



**Art. I-112**  
**Clip per asta**  
**Ø mm. 25 e 28**  
**e cerchio piatto**  
 Clip for pipe  
 Ø mm. 25 and 28  
 and flat hoop





**Art. 525**  
**Ostacolo regolabile con paletti,  
 ritti e traversa in PVC Ø mm.32**  
 Hurdle with Poles,  
 clips and crossbar in PVC Ø 32 mm.

pg.2

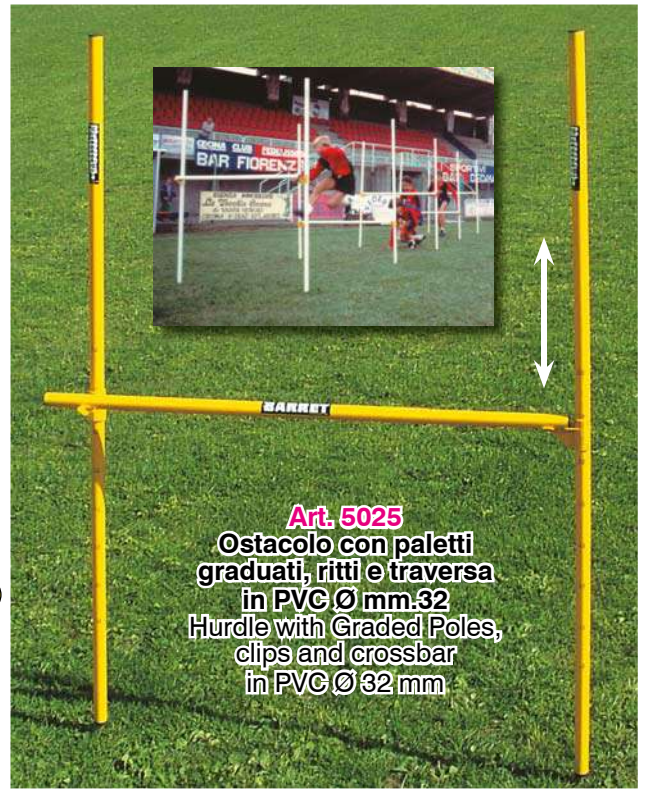

**Art. 5025**  
**Ostacolo con paletti  
 graduati, ritti e traversa  
 in PVC Ø mm.32**  
 Hurdle with Graded Poles,  
 clips and crossbar  
 in PVC Ø 32 mm

h. cm. 10 → 160



**Art. 012**  
**Traversa in PVC cm.110 Ø mm. 32**  
 Crossbar 110 cm. in PVC Ø 32 mm.



**Art. 012F**  
**Traversa cm. 110 in polipropilene  
 copolimero Ø mm.32  
 giallo o arancio fluo**  
 Crossbar 110 cm. in copolymer  
 polypropylene Ø 32 mm.  
 in fluorescent yellow and orange



**Art. 525F**  
**Ostacolo regolabile  
 costituito da 2 paletti h 170 cm. con  
 puntale, 1 traversa e 2 clips  
 in polipropilene copolimero  
 colore giallo o arancio fluo**  
 Hurdle with graded poles, clips and  
 crossbar in copolymer polypropylene  
 Ø 32 mm. (colors: fluorescent yellow  
 and orange)

pg.2

h. cm. 10 → 160



**Art. 007SP**

**Art. ELNR**

**Art. ELNR**  
**ELASTICO nero con velcro  
 lunghezza cm.135  
 da fissare ai paletti slalom  
 come traversa  
 ad altezza regolabile**  
 Black band length 135 cm.  
 with velcro  
 to be used as adjustable  
 height crossbar

**Art. 902013**



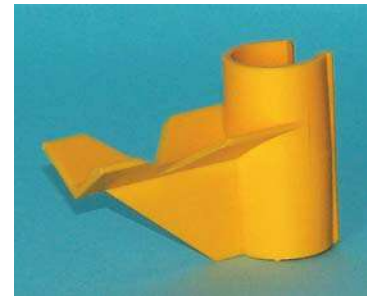

**Art. 011**  
Clip per sostegno traversa per asta Ø mm. 32 e 28  
Clip for crossbar for pipe Ø mm. 32 and 28



pg.2



**Art. CL17**  
Clip rotante per aste Ø mm. 32  
Rotating clip for two pipes Ø 32 mm.

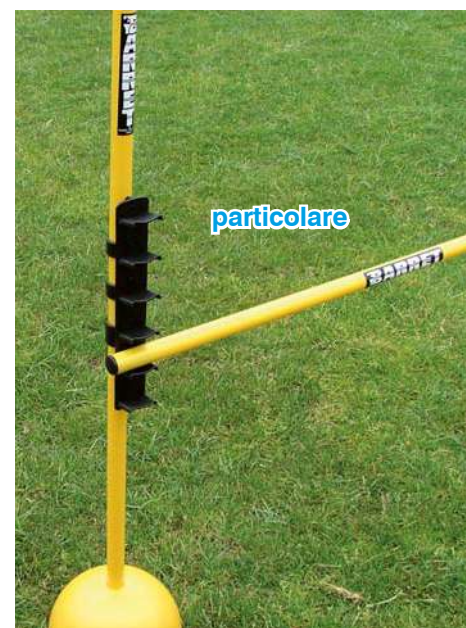



## OSTACOLI - Hurdles



pg.5

**Art. MH6 / MH9 / MH12**  
Mini-Over in PVC  
altezza fissa,  
cm. 15 / 23 / 30  
Ideali per i bambini  
delle scuole calcio

Mini-Over in PVC  
fixed height,  
15 / 23 / 30 cm.  
Best for soccer  
school kids



Tornano in posizione  
dopo ogni urto  
senza danneggiarsi  
These hurdles come  
back in position after  
any hit without being  
damaged

pg.3

pg.4

**Art. 80.12 / 80.14 / 80.16 / 80.18**  
**80.20 / 80.30 / 80.40 / 80.50 / 80.60**  
Ostacolo Over in PVC  
altezza fissa,  
cm.12-14-16-18-20-30-40-50-60  
Hurdle Over in PVC  
fixed height,  
12-14-16-18-20-30-40-50-60 cm.

pg.4

**Art.**  
**P031-A / P031 / P032**  
**P033 / P034 / P035**  
Ostacolo Over  
in PVC Ø mm. 32  
altezza fissa  
disponibile  
da 12 a 60 cm.  
Hurdle Over in PVC  
fixed height  
available  
from 12 to 60 cm.





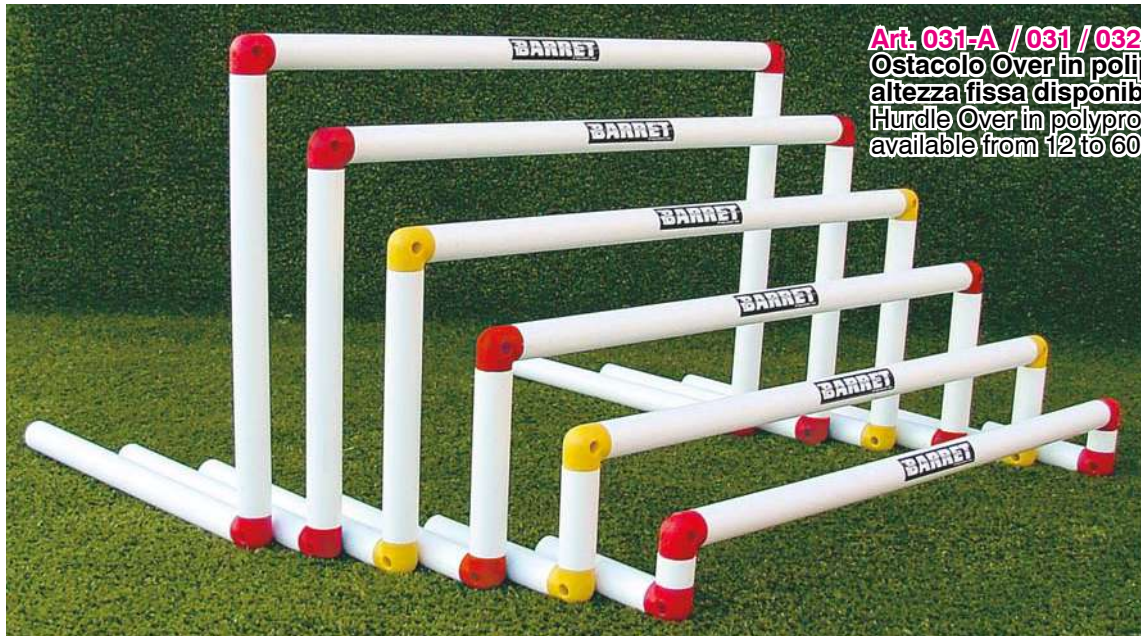

**Art. 031-A / 031 / 032 / 033 / 034 / 035**  
**Ostacolo Over in polipropilene Ø mm. 40**  
**altezza fissa disponibile da 12 a 60 cm.**  
**Hurdle Over in polypropylene, fixed height**  
**available from 12 to 60 cm.**

**Polipropilene**  
**copolimero**  
**Ø 40 mm.**  
**altamente**  
**resistente e**  
**flessibile fino a**  
**-5 gradi!**  
**Polypropylene**  
**copolymer**  
**40 mm. highly**  
**resistant and**  
**elastic till minus**  
**5 degrees!**

● pg.4



**Art. 235.1 / 235.2 / 235.3 / 235.4 / 235.5 / 235.6**  
**Ostacolo Over**  
**in ferro verniciato altezza fissa**  
**disponibile da 12 a 60 cm.**  
**Hurdle Over in painted iron,**  
**fixed height available**  
**from 12 to 60 cm.**

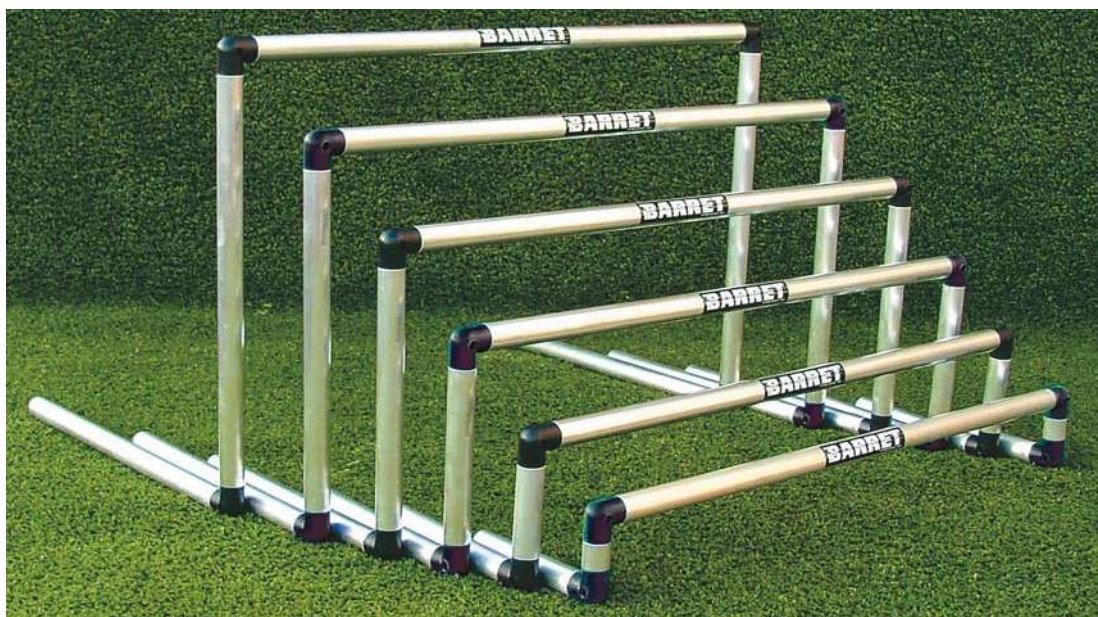

**Art. A031-A / A031 / A031-B / A032 / A033 / A034 / A035**  
**Ostacolo Over in alluminio Ø mm. 32 altezza fissa disponibile da 12 a 60 cm.**  
**Hurdle Over in aluminium, fixed height available from 12 to 60 cm.**



pg.4

**Art. 031-AF**  
**031F / 031-BF / 032F**  
**033F / 034F / 035F**

**Ostacolo over**  
**altezza fissa**  
**cm. 12-20-30-40-50-60**  
**in polipropilene**  
**copolimero**  
**alta resistenza**  
**Ø mm. 32**  
**colori: giallo e arancio**  
**fluorescente**  
 Over Hurdle 12 - 20 - 30  
 40 - 50 - 60 cm. height  
 polypropylene  
 copolymer  
 pipe Ø mm. 32  
 (colors: fluorescent  
 yellow and orange)



**Polipropilene**  
**copolimero**  
**FLUO**  
**altamente**  
**resistente e**  
**flessibile fino a**  
**-5 gradi!**  
 Polypropylene  
 copolymer  
 fluorescent  
 highly  
 resistant and  
 elastic till minus  
 5 degrees!

**Art. C031 / C032 / C033 / C034**

**Ostacolo Over**  
**con cerniere (richiudibile) in**  
**polipropilene**  
**copolimero Ø mm. 32**  
**colore giallo o arancio**  
**fluorescente**  
**massima altezza**  
**cm. 20 - 30 - 40 - 50**  
 Hinged Hurdle Over  
 (foldable) in polypropylene  
 copolymer pipe Ø mm. 32  
 fluorescent yellow and orange  
 20 - 30 - 40 - 50 cm.  
 maximum height



pg.4

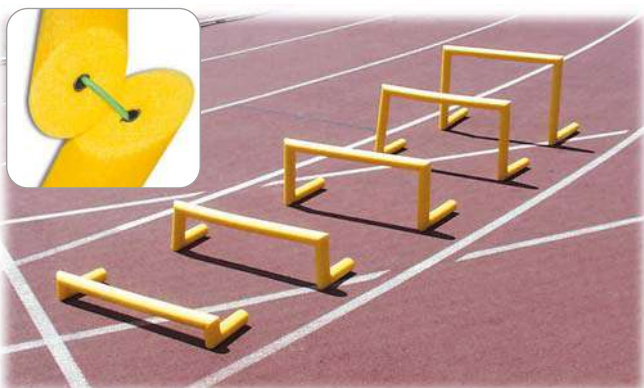

pg.5

**Art. P15421**  
**Serie 5 ostacoli Over supersoft in polietilene**  
**espanso colore giallo, leggerissimi**  
**ideali per uso indoor**  
**altezza cm. 10-20-30-40-50 (il set comprende**  
**un ostacolo per ciascuna altezza)**  
 Set of 5 Hurdles over supersoft yellow color  
 very light, best for indoor use  
 fixed height cm. 10-20-30-40-50





**Art. 006**  
**Ostacolo con cerniere (richiudibile)**  
**altezza regolabile da 10 a 60 cm.**  
**in PVC Ø mm. 32**  
Hinged Hurdle (foldable)  
adjustable height  
from 10 to 60 cm. in PVC



pg.5

**Art. 006F**  
**Ostacolo con cerniere (richiudibile)**  
**altezza regolabile da 10 a 60 cm.**  
**in polipropilene copolimero Ø mm. 32**  
**colore giallo o arancio fluorescente**  
Hinged Hurdle (foldable) adjustable height  
from 10 to 60 cm. in polypropylene  
copolymer pipe Ø 32 mm.  
(colors: fluorescent yellow and orange)



**Art. A004** **Ostacolo con cerniere (richiudibile)**  
**altezza regolabile da 10 a 60 cm.**  
**in alluminio Ø mm. 32**  
Hinged Hurdle (foldable) adjustable height  
from 10 to 60 cm. in aluminium





**Art. P0055**  
**Ostacolo Telescopico graduato, altezza regolabile da 40 a 60 cm. in PVC**

Telescopic Hurdle - graded - height adjustable from 40 to 60 cm. in PVC



**Completamente smontabili, minimo ingombro!**  
Dismountable legs, easy to transport

pg.5

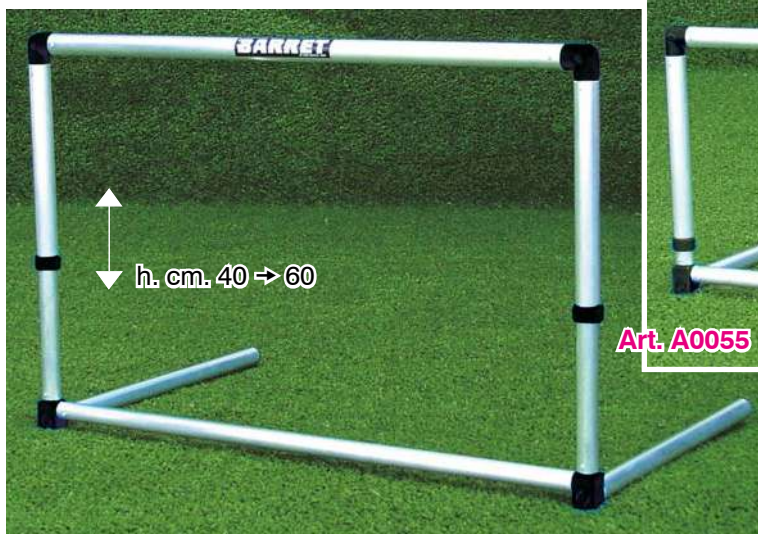

**Art. A0055**

**Art. A0055**  
**Ostacolo Telescopico graduato, altezza regolabile da 40 a 60 cm. in alluminio**  
Telescopic Hurdle - graded - height adjustable from 40 to 60 cm. in aluminium

**Montanti graduati in cm.**  
Graded in cm.

**Completamente smontabili, minimo ingombro!**  
Dismountable legs, easy to transport





**Art. P005**  
**Ostacolo Telescopico graduato,**  
**altezza regolabile da 60 a 100 cm. in PVC**  
Telescopic Hurdle - graded - height adjustable  
from 60 to 100 cm. in PVC

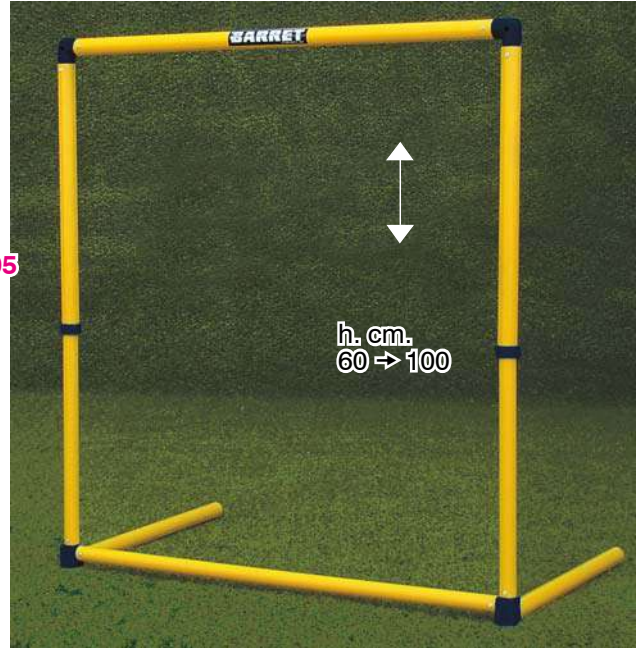

**Completamente smontabili,**  
**minimo ingombro!**  
Dismountable legs,  
easy to transport

pg.5



**Art. A005**  
**Ostacolo Telescopico graduato,**  
**altezza regolabile da 60 a 100 cm. in alluminio**  
Telescopic Hurdle - graded  
height adjustable from 60 to 100 cm. in aluminium

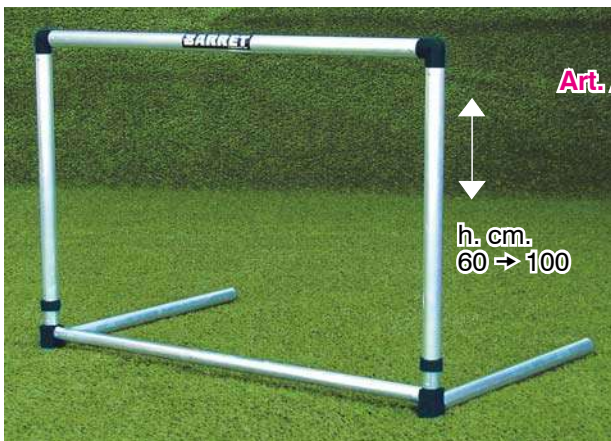

**Completamente smontabili,**  
**minimo ingombro!**  
Dismountable legs,  
easy to transport

**Montanti graduati in cm.**  
Graded in cm.





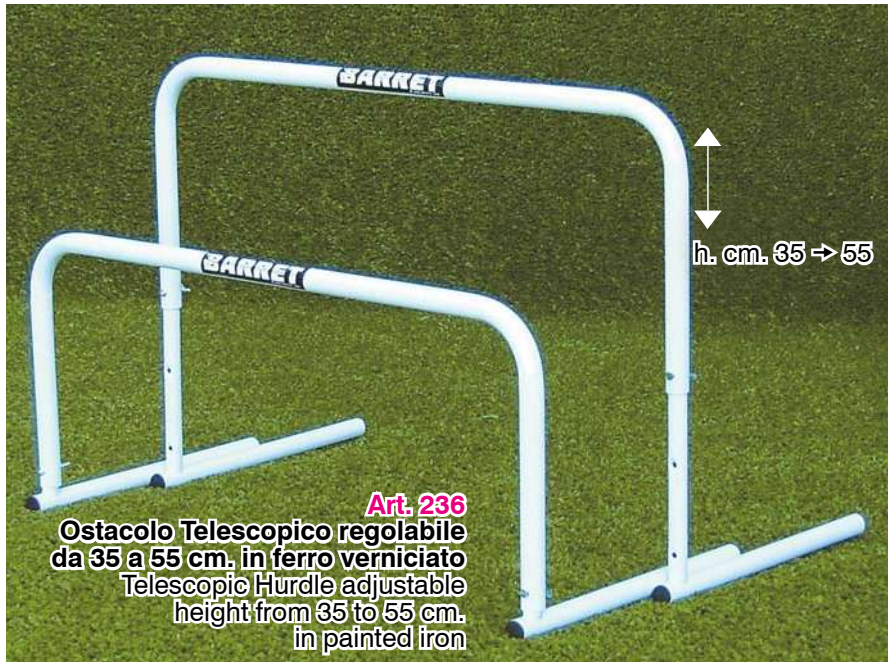

Art. H6912  
Mini-Ostacolo per bambini in plastica antiurto larghezza traversa cm. 45 altezza regolabile a cm. 15-23-30  
Mini-Hurdle in plastic for kids 45 cm. wide adjustable height at 15-23-30 cm.

pg.5



Art. 036  
Mini-Ostacolo per bambini regolabile da 10 a 50 cm. in plastica  
Mini-Hurdle for kids adjustable height from 10 to 50 cm. in plastic

IDEALI PER USO INDOOR E PER PALESTRE

For indoor use





**SEMPRE IN PIEDI  
DOPO OGNI URTO!  
THEY ALWAYS COME  
BACK UP AFTER  
ANY HIT!**

pg.5

**Art. 5020 / 5021 / 5022 / 5023**  
**Ostacolo Basculante in PVC Ø mm. 28**  
**altezza fissa cm. 30 / 40 / 50 / 60**  
Self-Straightening Hurdle in PVC fixed height,  
available in 30 / 40 / 50 / 60 cm.



pg.5

**Art. A5020 / A5021 / A5022 / A5023**  
**Ostacolo Basculante in alluminio Ø mm. 28**  
**altezza fissa cm. 30 / 40 / 50 / 60**  
Self-Straightening Hurdle in aluminium  
fixed height, available in 30 / 40 / 50 / 60 cm.

**SEMPRE IN PIEDI  
DOPO OGNI URTO!  
THEY ALWAYS COME  
BACK UP AFTER  
ANY HIT!**





## KIT CALCIO TENNIS - Soccer Tennis Kits

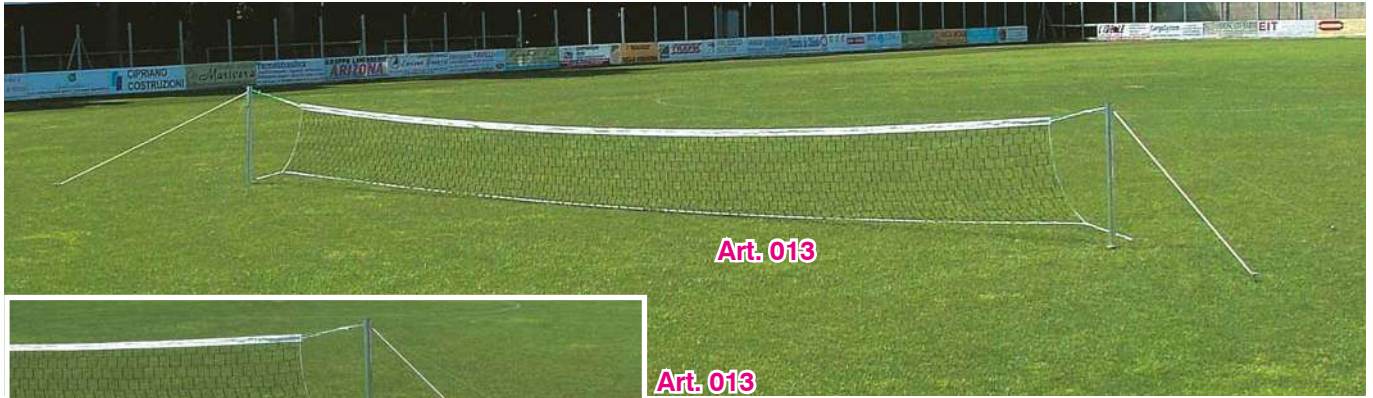

**Art. 013**



**Art. 013**

**Kit Calcio Tennis pali in alluminio sezione mm. 60 completo di rete mt. 9,85 con tiranti, picchetti e nastro di delimitazione, utilizzabile solo su terreni naturali**  
Soccer Tennis Kit aluminium poles 60 mm. with 9,85 meter net, tightening ropes, pegs and tape for bounds - for natural grass

pg.6



**Art. 014**

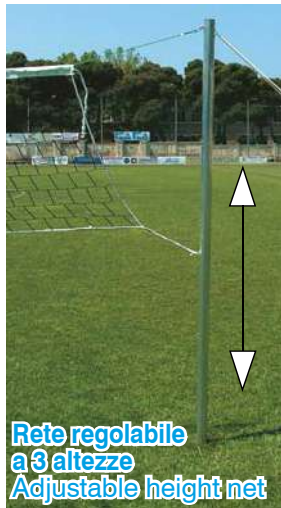

**Art. 014**  
**Kit Calcio Tennis pali in alluminio sezione mm. 60 completo di rete mt. 9,85 regolabile a 3 altezze (cm. 110/170/230) con tiranti, picchetti e nastro di delimitazione, utilizzabile solo su terreni naturali**  
Soccer Tennis Kit aluminium poles 60 mm. with 9,85 meter net adjustable at 3 different heights, tightening ropes, pegs and tape for bounds for natural grass



**Art. 014**



**Art. NS200**

pg.29

**Rotolo nastro stradale bianco/rosso mt. 200 (compreso nei kit Art. 013 e Art. 014)**  
Red/White Tape length 200 meters (supplied with kit Art. 013 and Art. 014)





**Art. 013.N**  
**Kit Calcio Tennis pali in PVC**  
**completo di rete mt. 3,30**  
**tiranti e picchetti**  
**per terreni naturali**  
Soccer Tennis Kit PVC poles  
with 3,30 meter net  
tightening ropes and pegs  
for natural grass

pg.5



**Art. 013.G** Kit calcio tennis pali in PVC  
con rete mt.10 - altezza cm.130  
con tiranti, picchetti e sacca  
per terreni naturali  
Soccer Tennis Kit PVC poles  
10 meter long 130 cm. height net with  
ropes, steel hooks and bag  
for natural grass



pg.5

**Art. 013.P**  
**Kit calcio tennis**  
**con rete mt. 3**  
**utilizzabile anche**  
**su terreni sintetici**  
**o indoor**  
**con sacca**  
Soccer Tennis Kit  
3 meter net - with bag  
also for artificial  
grass or indoor



**Art. 013.SP**

**Kit calcio tennis con rete cm.  
450x170**

**utilizzabile anche  
su terreni sintetici o indoor**  
con sacca

Soccer Tennis Kit 4,5x1,7 meter net  
with bag, also for artificial grass  
or indoor



pg.5

**Art. 013.60**

**Kit calcio tennis  
con rete cm. 600x90**

**utilizzabile anche  
su terreni sintetici  
o indoor** con sacca

Soccer Tennis Kit  
6,0x0,9 meter net  
with bag, also  
for artificial grass  
or indoor



**Art. 013.S**

**Kit Calcio Tennis TATTICO**

**pali in polipropilene  
completo di rete in PVC mt. 2,30 regolabile in  
altezza, tiranti e basi in ferro verniciato**  
**utilizzabile anche su terreni sintetici o indoor**

Soccer Tennis Kit polypropylene poles  
with adjustable height PVC net 2,30 meter long,  
tightening ropes and painted steel bases  
also for artificial grass or indoor

**Nasconde per qualche istante la visione  
del pallone, determinando risposte a livello  
neuromuscolare e migliorando cinestesia e  
sensibilità nel tocco di palla**

This Soccer Tennis Kit hides the ball from  
player's visibility stimulating neuro muscular  
reflexes and improving ball control

pg.6



**Art. 013.SB**

**Borsa per Kit calcio tennis  
Art. 013.S**

Bag to carry soccer tennis  
kit Art. 013.S





## ARCHI DI PRECISIONE - Precision passing arcs

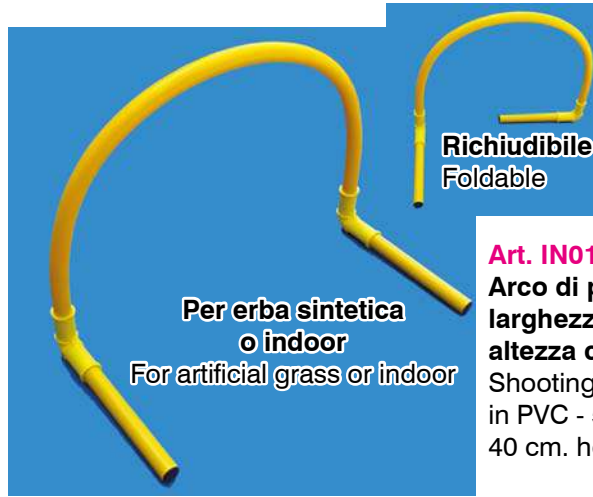

pg.5

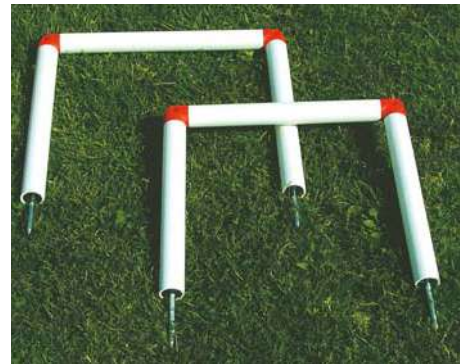

**Art. 020 / 021 / 022**  
Arco di precisione in polipropilene  
Ø 40 mm. cm. 45x45 / 40x40 / 35x35  
Shooting/Passing Arc  
in polypropylene Ø 40 mm.  
dim. 45x45 / 40x40 / 35x35 cm.



**Art. A020 / A021 / A022**  
Arco di precisione  
in alluminio Ø 32 mm.  
cm. 45x45 / 40x40 / 35x35  
Shooting/Passing Arc  
in aluminium Ø 32 mm.  
dim. 45x45 / 40x40 / 35x35 cm.





## FORCHE - Heading Trellises



**Art. F203**

pg.6

**Art. F203**

**Forca doppia  
in ferro verniciato  
telescopica, smontabile  
bussola inclusa  
altezza da terra cm. 300  
(palloni esclusi)**  
Double Heading Trellis  
in painted iron  
telescopic, dismantable,  
underground socket included,  
height 300 cm. off ground  
(balls not included)

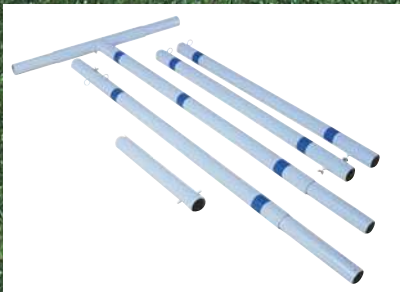

**Art. 039.4 / 039.5**

**Pallone per  
forca in pelle sintetica  
disponibile mis. 4 e 5**  
Ball for Heading Trellis,  
in synthetic leather  
available size 4 and 5



**Art. 037F**

**Forca singola  
in acciaio zincato,  
con zavorra,  
per erba sintetica o indoor  
altezza da terra cm.300  
(pallone escluso)**  
Single Heading Trellis  
in galvanized iron weighted for  
artificial grass or indoor  
height 300 cm. off ground  
(ball not included)



**Art. ULTVE5**

**Pallone per forca  
Trial n. 5  
in gomma  
doppio strato  
gr. 420  
Ø cm. 21,5**  
Trial rubber Ball  
for Heading trellis  
size 5  
double stratum

**Art. ULTVE4**

**Pallone per forca Trial n. 4  
in gomma doppio strato gr. 250 Ø cm. 20**  
Trial rubber Ball for Heading trellis size 4 double stratum





pg.6

**Art. 038**  
**Forca doppia**  
**in alluminio**  
**tubo sezione 60 mm.**  
**altezza da terra cm.300**  
**(palloni esclusi)**  
 Double Heading Trellis  
 in aluminium  
 pipe section 60 mm.  
 300 cm. height off ground  
 (balls not included)

**Art. B038**  
**Bussola per forca**  
**Art. 038 (optional)**  
 Underground socket  
 for Art. 038 (optional)



**Art. ACTP40**  
**Attrezzo per l'allenamento**  
**al colpo di testa**  
**applicabile a porte di qualsiasi tipo**  
**per mezzo di fettucce elastiche,**  
**in PVC Ø mm. 40**  
**(pallone escluso)**  
 Header training tool  
 to be easily applied to goals of any type  
 by means of elastic tapes,  
 PVC pipe Ø 40 mm.  
 (ball not included)



pg.9

**Con questo attrezzo**  
**è possibile verificare**  
**giornalmente i**  
**miglioramenti**  
**nell'elevazione**  
**degli atleti**  
 This instrument tests  
 players' daily jump  
 improvements

**Art. HJT Head Jump Tester - strumento polivalente di misurazione**  
**ed allenamento, permette la valutazione delle qualità muscolari**  
**degli arti inferiori, dell'elevazione dei giocatori, del loro modo di**  
**colpire la palla di testa e dell'ampiezza del tuffo del portiere**  
 Instrument that allows the training and measurement of jump ability of  
 players and goalkeepers



## BARRIERE SPECIALI - GK TRAINING



La palla passa attraverso le finestre senza perdere velocità

Telo cm.250x173  
250x173 cm. sheet

Ball goes through the windows without losing speed

**Art. 003WB**  
**BARRIERA CON FINESTRE**  
per l'allenamento ai calci di punizione e per il miglioramento dei tempi di reazione del portiere in caso di tiri improvvisi  
**kit completo**  
WINDOW BARRIER for free kicks and Goalkeeper training to fast and sudden shots **complete kit**

pg.1

**Art. 003WBS**  
**STRUTTURA SUPERIORE**  
barriera con finestre, applicabile al carrello porta sagome Art. 003  
Window Barrier UPPER PART to be fixed upon trolley Art. 003



**Art. 003RX**  
**BARRIERA FILTRANTE REFLEX** **kit completo**  
REFLEX FILTERING BARRIER on wheels - complete kit



**Nuovo sistema di fissaggio**  
New more resistant elastics and hooks

pg.1

**Art. 003RXS**  
**STRUTTURA SUPERIORE** barriera filtrante REFLEX, applicabile al carrello porta sagome Art. 003  
Reflex Filtering Barrier UPPER PART to be fixed upon trolley Art. 003



**Art. 003RXS**

**Art. 003**

**INNOVATIVO ATTREZZO FONDAMENTALE PER L'ALLENAMENTO DEI RIFLESSI DEL PORTIERE. LA PALLA (INVISIBILE PER IL PORTIERE AL MOMENTO DEL CALCIO) FILTRA ATTRAVERSO LE STRISCE ED ARRIVA IN PORTA ALL'IMPROVISO ASSUMENDO TALVOLTA TRAIETTORIE IMPREVEDIBILI. ATTREZZO DA POSIZIONARE IN PROSSIMITÀ DELL'AREA PICCOLA**  
**A revolutionary device for goalkeeper's reflex training.**  
**The goalkeeper cannot see the ball until it passes through the stripes. The direction of the ball is often unpredictable!**  
**To be placed not too far from goalkeeper's area**



**L'ATTREZZO PUO' INOLTRE ESSERE UTILIZZATO COME UNA COMUNE BARRIERA PER L'ALLENAMENTO DEI CALCI DI PUNIZIONE**  
**It is also very useful for free kick practising for both kicker and goalkeeper!**





## MURI - TELAI CON RETE - Rebounders - Iron frames with nets



Vista frontale  
Front view



Vista laterale  
Side view

Video dimostrativo  
disponibile  
su [www.barretsport.com](http://www.barretsport.com)  
Video available at  
[www.barretsport.com](http://www.barretsport.com)

### Art. 5011

**Muro per allenamento portieri in vetroresina  
montato su telaio con 4 ruote**

Fiberglass Goalkeeper Rebounder  
mounted on frame with  
4 wheels

**Dimensioni:**  
altezza cm.200  
larghezza cm.130  
Peso Kg.100

Dimensions:  
height 200 cm.  
width 130 cm.  
weight 100 Kg.

pg.6

**Calciando o lanciando la palla  
verso il muro essa assumerà  
direzioni di rimbalzo  
imprevedibili, favorendo  
l'allenamento dei riflessi  
del portiere**

By kicking or throwing the ball  
against the wall it will rebound in  
different directions,  
testing and training GK's reflexes



Vista posteriore  
Back view

**Zavorra  
in cemento  
inclusa**  
Concrete  
ballast  
included

**Consente l'allenamento con  
o senza il preparatore atletico**  
Goalkeeper can exercise  
by himself as well



**Con superficie superiore a semisfere  
e superficie inferiore liscia**  
Upper side with hemispheres  
and smooth lower side





**Art. 5012SC**  
**Muro per allenamento portieri in vetroresina cm. 200x130**  
**installato su carrello in acciaio zincato con ruote**  
 Fiberglass Goalkeeper rebounder 200x130 cm. installed on a  
 galvanized steel trolley with wheels

**New!**

pg.6



**Art. KMC3S**  
**Kit superiore muro allenamento**  
**portieri per adattamento a carrello**  
**Art. NCP3S oppure Art. 003**  
 Rebounder kit upper part to be fixed  
 upon trolley Art. NCP3S or Art. 003

**Rimuovendo il pannello in vetroresina**  
**ed eventualmente il telaio di sostegno,**  
**si può utilizzare il carrello porta 3**  
**sagome Art. NCP3S**

By removing the fiberglass panel and the  
 support frame, you can use the trolley for  
 carrying 3 mannequins Art. NCP3S



**Art. PVLSC**  
**Pannello in vetroresina con superficie superiore a semisfere e superficie inferiore liscia, munito di ganci e**  
**staffa per ancoraggio - dimensioni cm. 200x130**  
**Può essere acquistato separatamente ed installato facilmente sulla Barriera Filtrante Reflex Art. 003RX**  
**oppure sulla Barriera con Finestre Art. 003WB**  
 Fiberglass panel with upper hemisphere surface and lower smooth surface, equipped with hooks and anchor  
 bracket - size 200x130 cm. It can be purchased separately and easily installed both on the Reflex Filtering Barrier  
 Art. 003RX and on the Window Barrier Art. 003WB





Kg. 50



**Art. 5010**

**Muro per allenamento giocatori a 3 facce in vetroresina montato su telaio con 3 ruote**  
3 side Fiberglass Players' Rebounder mounted on frame with 3 wheels  
Dimensions: 1,3 m. width x 1,1 m. height every side weight 50 Kg.



pg.6



**Art. 5050**

**Muro per allenamento giocatori a 2 facce di cui una ad inclinazione regolabile, interamente in vetroresina montato su telaio con 4 ruote**  
2 side Fiberglass Players' Rebounder mounted on frame with 4 wheels one side can be inclined

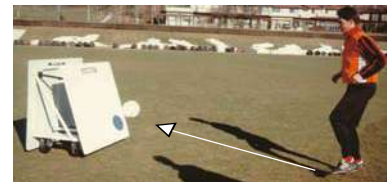

Kg. 50

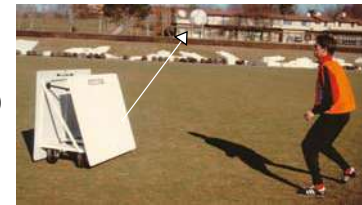

**Dimensioni:**  
m. 1,3 larghezza x m. 1,1 altezza ciascuna faccia  
**peso Kg. 50**  
Dimensions:  
1,3 m. width x 1,1 m. height every side weight 50 Kg.

**Attraverso l'utilizzo della parete ad inclinazione regolabile è possibile determinare traiettorie di risposta della palla verso l'alto al fine di sollecitare il tiro al volo, il colpo di testa ed il controllo di palla**  
Thanks to the adjustable inclination you can get an upward ball rebound and train acrobatic shooting, headers and ball control



**Art. MP501N**

**Muro prismatico in vetroresina a 3 facce lisce di dimensioni  
cm.107x140 - cm.107x120 - cm.107x108 - peso Kg.48 - con asole per il trasporto  
\*\*utilizzabile contemporaneamente da 2 lati ed in 4 diverse posizioni\*\***

3 side Fiberglass Players' Rebounder with side dimensions  
107x140 cm. - 107x120 cm. - 107x108 cm. weight 48 Kg. with slots for transport  
**\*\*allows 4 different training positions on both sides simultaneously\*\***

pg.6



Permette di ottenere la più ampia  
varietà di rimbalzi e traiettorie, utili  
per il miglioramento del controllo di  
palla, del passaggio, del tiro a volo  
e del colpo di testa

1

**Posizione "in piedi" con 3 facce  
perpendicolari al terreno di gioco**  
Standing position with all sides  
perpendicular to the ground



2

**Posizione con base a terra cm.107x108**  
**Allenamento con superfici di rimbalzo  
ad inclinazione alta e medio-alta**  
Position with 107x108 cm. base  
Training with high and medium inclination  
rebounding sides

Allows the widest  
variety of rebounds in  
order to improve ball  
control, passing and  
shooting



3

**Posizione con base a terra  
cm.107x120**  
**Allenamento con superfici  
di rimbalzo ad  
inclinazione alta e bassa**  
Position with 107x120 cm. base  
Training with high and low  
inclination rebounding sides



**Rinforzo interno  
per l'ottimizzazione del rimbalzo**  
Internal reinforcement for rebound improvement

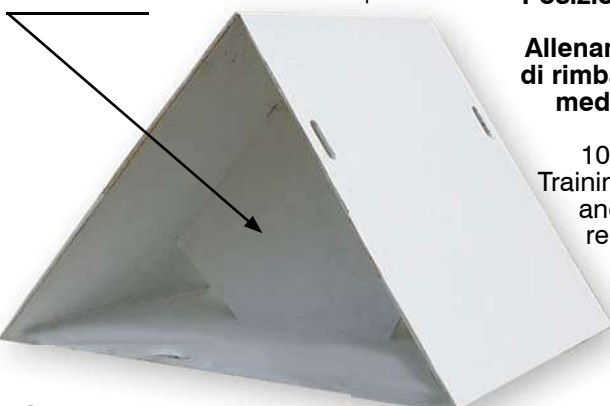

4

**Posizione con base a terra  
cm.107x140**  
**Allenamento con superfici  
di rimbalzo ad inclinazione  
medio-bassa e bassa**  
Position with  
107x140 cm. base  
Training with medium-low  
and low inclination  
rebounding sides





**Art. PLRB16**

**Muro prismatico in vetroresina a 3 facce lisce  
larghezza cm.135 - altezza massima cm.62  
con asole per il trasporto - peso kg.24**

**\*\*utilizzabile contemporaneamente da 2 lati ed in 3 diverse posizioni\*\***

3 side Fiberglass Players' Rebounder  
width 135 cm. - maximum height 62 cm  
with slots for transport - 24 kg. weight

**\*\*allows 3 different training positions on both sides simultaneously\*\***

pg.6

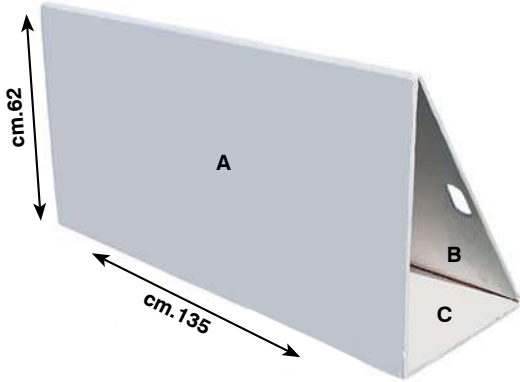

1

**Posizione con superficie A perpendicolare  
al terreno e superficie B molto inclinata**  
Position with 90 degrees A side and high inclination B side

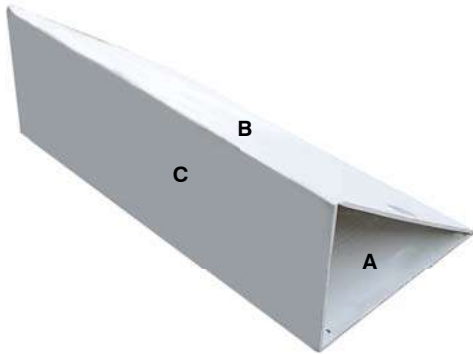
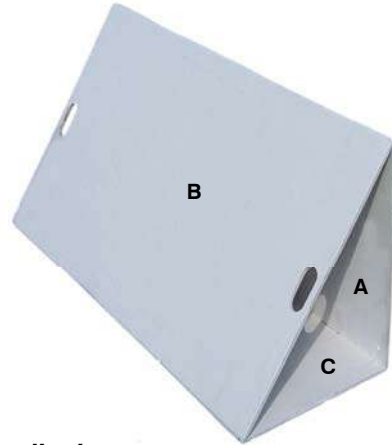

2

**Posizione con superficie C perpendicolare  
al terreno e superficie B inclinata**  
Position with 90 degrees C side and low inclination B side

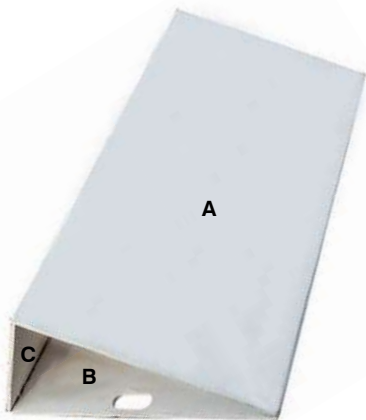
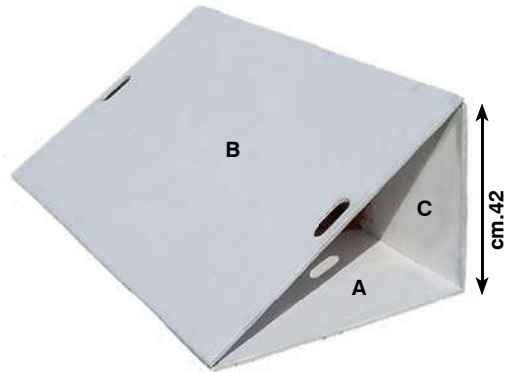

3

**Posizione con superfici A e C  
a diversa inclinazione**  
Position with A and C sides differently inclined

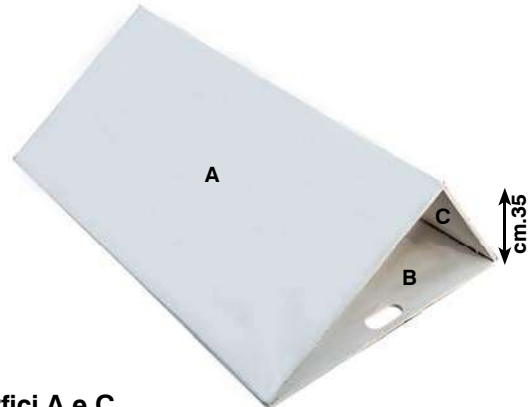

**Permette di ottenere la più ampia  
varietà di rimbalzi e traiettorie, utili  
per il miglioramento del controllo di  
palla, del passaggio, del tiro a volo  
e del colpo di testa**

**Rinforzo interno  
per l'ottimizzazione del rimbalzo**  
Internal reinforcement for rebound improvement

**Allows the widest  
variety of rebounds in  
order to improve ball  
control, passing and  
shooting**





pg.6

**Art. PAL PAL ORIGINAL - Kit 3 pannelli orientabili in legno finlandese trattato a 5 strati rivestiti in gomma, completo di 4 aste metalliche di fissaggio, 6 pomelli di sicurezza e 1 martello per il fissaggio**

Pal Original - Kit 3 rebounding sides in Finnish multi stratum wood covered with rubber, with 4 metal pegs, 6 safety protections and 1 hammer

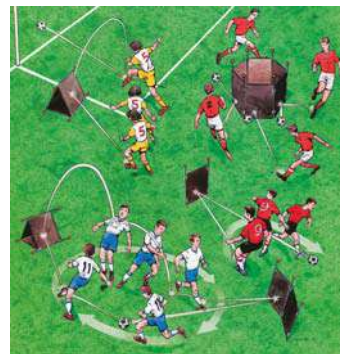

**Ideale per l'effettuazione di esercizi individuali e di gruppo volti al miglioramento della coordinazione motoria, del controllo di palla, del passaggio, del tiro e del gioco aereo**

Very useful for individual and group exercises to improve coordination, ball control, passing and shooting

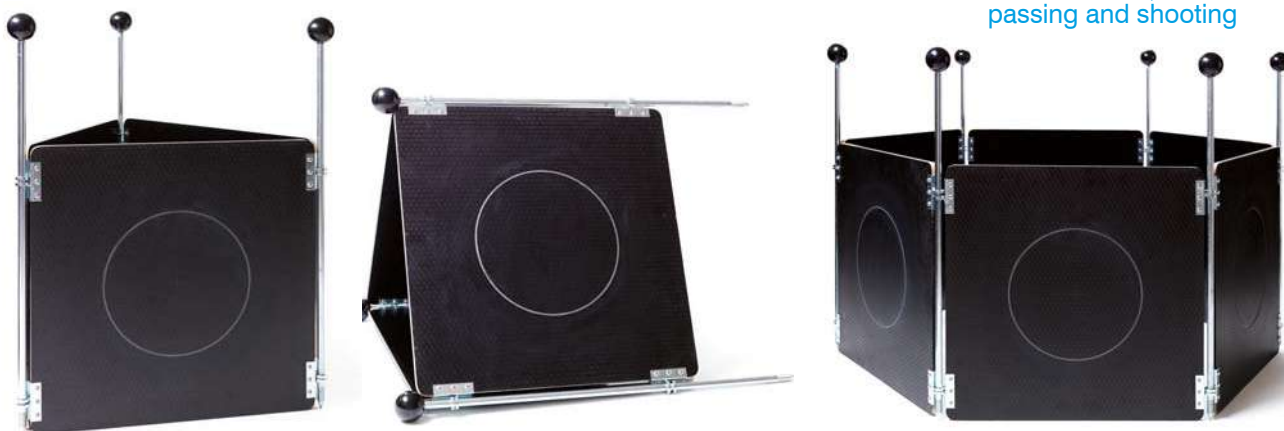

pg.6

**Art. TM001**

**Muro triangolare in legno multistrato marino, trattato con vernice impermeabilizzante dimensioni lato cm.150x50**

**Attraverso l'uso in posizione verticale è possibile determinare traiettorie di risposta della palla verso l'alto al fine di sollecitare il tiro a volo, il colpo di testa e lo stop**

Triangular rebounder made of marine wood treated with special paint against humidity - side size 150x50 cm. By placing it in vertical position you will receive an upward ball rebound to train acrobatic shooting, header and ball control.



pg.7

**Art. PTI.503**

**Telaio con rete in acciaio verniciato, bifacciale ricurvo su un lato - inclinazione regolabile dim. cm. 111x105x63**  
2 face adjustable inclination iron frame with net for goalkeepers and players size 111x105x63 cm.





**Art. SCVR16**

**Disco in vetroresina con maniglie per l'allenamento della reattività del portiere sulle deviazioni da tiro o colpo di testa ravvicinato diametro cm.47 peso kg.2**

Fiberglass Discus with handles

for close shot and deflection GK training - diameter 47 cm. weight 2 kg.

pg.7



**Art. 5030.T**

**Telaio con rete in alluminio dim. cm.90x70 ad inclinazione regolabile con maniglie impugnabili dall'allenatore.**

**Consente la simulazione di colpi di testa e tiri acrobatici per un allenamento alternativo del portiere**

Aluminium frame with net size 90x70 cm. adjustable inclination with handles for trainer to simulate headers and acrobatic shooting trajectories for new GK exercises



**Art. PTI.5858**

**Telaio con rete in metallo dim. cm.58x58 con maniglie impugnabili dall'allenatore.**

**Consente la simulazione di colpi di testa e tiri acrobatici per un allenamento alternativo del portiere**

Metal frame with net size 58x58 cm. with handles for trainer to simulate headers and acrobatic shooting trajectories for new GK exercises





**Art. 5030**  
**Telaio con rete cm. 130 x 130**  
**in ferro verniciato**  
**ad inclinazione regolabile**  
 Painted iron frame with net,  
 dimensions 130x130 cm.  
 adjustable inclination

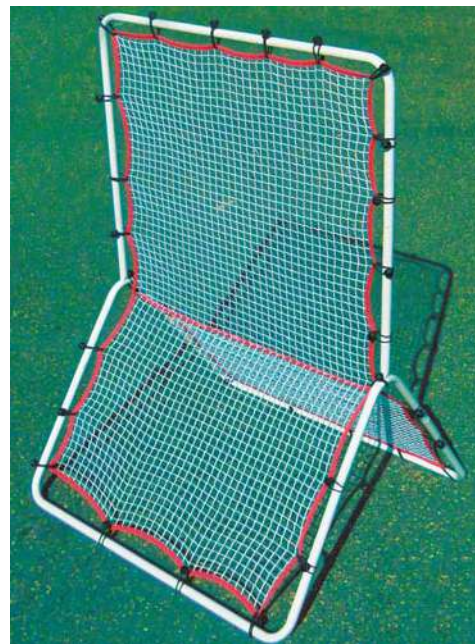

**Art. 503.BF**  
**Telaio con rete in ferro verniciato, bifacciale**  
**a doppia inclinazione, altezza cm.150 larghezza**  
**cm.100 con picchetti per fissaggio a terra,**  
**per allenamento portieri e giocatori**  
 Iron frame with net, in painted iron 2 sides double  
 inclination height 150 cm. width 100 cm. with anchoring  
 hooks for goalkeepers and players

pg.7

**Art. 5035G** Telaio con rete **cm.105 x 105** in ferro cromato ad  
 inclinazione regolabile, per allenamento portieri e giocatori  
 Iron frame with net in chromed iron dimensions 105x105 cm.  
 adjustable inclination for goalkeepers and players

**Prodotto professionale**  
**in ferro cromato**  
 Professional in  
 chromed iron

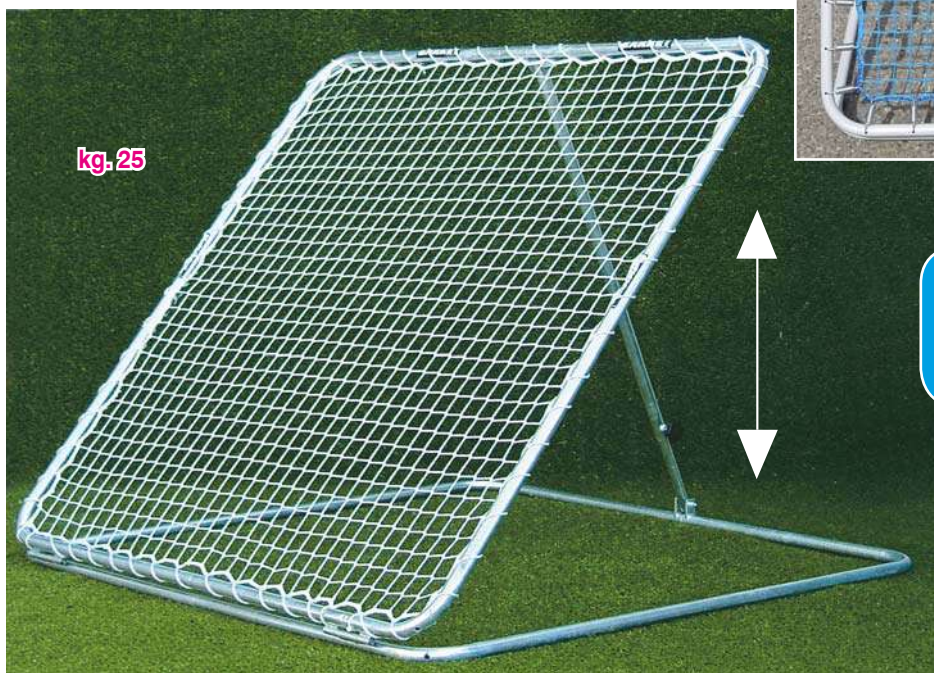

**Prodotto professionale**  
**in ferro zincato**  
 Professional in  
 galvanized iron

**Art. 5040**  
**Telaio con rete cm. 140 x 140**  
**in ferro zincato ad inclinazione**  
**regolabile, per allenamento**  
**portieri e giocatori**  
 Iron frame with net in galvanized  
 iron dimensions 140x140 cm.  
 adjustable inclination  
 for goalkeepers and players





**New!**

**Art. 50.220**  
Telaio con rete  
**cm. 220 x 180**  
in ferro zincato  
ad inclinazione regolabile,  
per allenamento  
portieri e giocatori  
Iron frame with net in  
galvanized iron dimensions  
220x180 cm.  
adjustable inclination  
for goalkeepers  
and players

pg.7

**Prodotti professionali  
in ferro zincato**  
Professional in  
galvanized iron



**Art. 5041**  
Telaio con rete **cm. 315 x 230** in ferro zincato  
ad inclinazione regolabile,  
per allenamento portieri e giocatori  
Iron frame with net, in galvanized iron  
dimensions 315 x 230 cm.  
adjustable inclination  
for goalkeepers and players



**Art. 4640**  
Coppia ruote gommatae per  
un agevole trasporto del  
telaio Art. 5041 (optional)  
Pair of wheels for Art. 5041  
(optional)  
Si installano sulla base  
d'appoggio nelle posizioni  
contrassegnate con 'R'





Video dimostrativo disponibile su [www.barretsport.com](http://www.barretsport.com)

Video available at [www.barretsport.com](http://www.barretsport.com)

**Art. DT01**

**Deviatore di traiettoria**

Tubi in alluminio, con cerniere e piedini di stabilità. Coadiuvano l'allenamento quotidiano del portiere ed il suo eventuale recupero post traumatico

**BREVETTATO**

SHOT DEVIATOR - pipes in aluminium, with hinges and stability pegs - very useful to improve GK reactivity and to accelerate injury recovery  
**PATENTED**

**Brevettato  
Patented**

pg.6

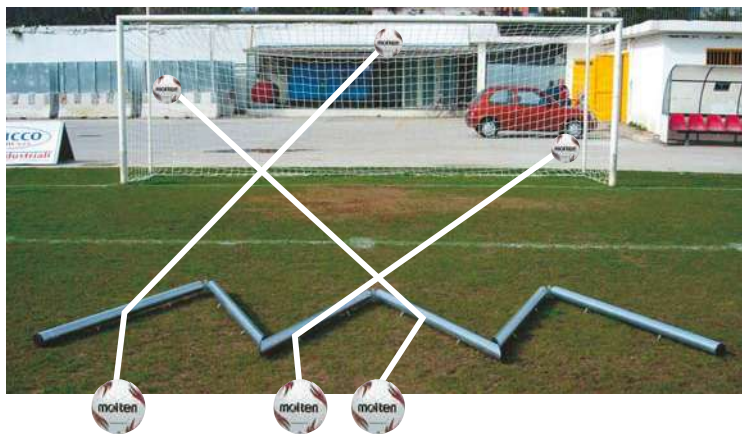

**Borsa per il trasporto inclusa**  
Bag included

Si consiglia di inumidire l'erba di fronte all'attrezzo per incrementare la velocità della palla calciata rasoterra prima dell'impatto con il Deviatore  
We recommend to wet the grass in front of the training device in order to let the ball hit the deviator at a higher speed



Video dimostrativo disponibile su [www.barretsport.com](http://www.barretsport.com)

Video available at [www.barretsport.com](http://www.barretsport.com)

**Art. BP63**

**BALL PLAYNING Modello Mundial - telo in PVC con rilievi gonfiabili e riempibili con acqua per l'allenamento dei riflessi del portiere metri 5 x 2,5 - completo di borsa e pompa per la gonfiatura**

Ball Playning Mundial for GK training in PVC size 5 x 2,5 meters with air and water bubbles, complete with pump and bag



pg.6

Prodotto ideato e brevettato da Mario Quaglieri, preparatore portieri professionista



**Bagna il Ball Playning prima dell'uso per incrementare la velocità della palla!**

Always wet your Ball Playning to increase ball speed!





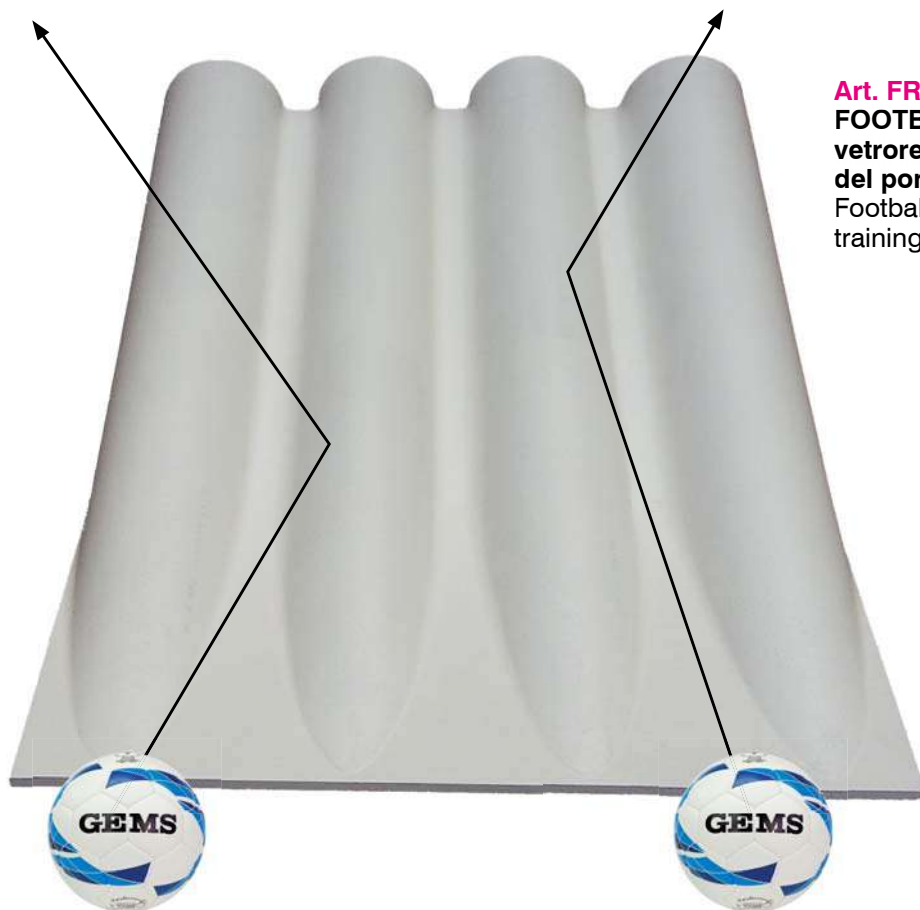

**Art. FRM16**  
**FOOTBALL RAMP - attrezzo in vetroresina per l'allenamento dei riflessi del portiere sui tiri ravvicinati e deviati**  
Football Ramp - fiberglass deviator for GK training to close highly deflected shots

**Bagna il Football Ramp prima dell'uso per incrementare la velocità della palla!**  
Always wet your Football Ramp to increase ball speed!

pg.6

**dimensioni: cm.150x110 ad inclinazione regolabile per mezzo di due piedi telescopici**  
dimensions: 150x110 cm. adjustable inclination by means of two telescopic feet



pg.6

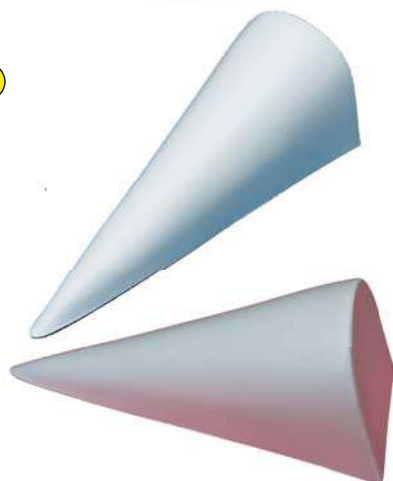

**Art. BDV15**  
**Cuspide in vetroresina appesantito con cemento, dimensioni cm.56x21x21h per allenamento dei riflessi del portiere**  
Fiberglass cusp with concrete filling  
dimensions 56x21xh21 cm. for GK training

**Posizionando una serie di cuspidi nell'area piccola si ottengono deviazioni della palla improvvise, utili per l'allenamento dei riflessi e della reattività del portiere**  
Train goalkeeper's reactivity to sudden and close deflections by placing a number of cusps near the GK's area





**Art. FRA**  
**FOOTBALL RACK** - attrezzo in ferro  
 zincato per l'allenamento dei riflessi del  
 portiere sui tiri ravvicinati e deviati  
**dimensioni cm.160x54 - peso kg. 13**  
 Football Rack - galvanized iron deviator  
 for training of GK reflexes on close and  
 deflected shots  
 size 160x54 cm. - weight 13 kg.

pg.6



**Art. FW18**  
**FOOTBALL WAVE** - attrezzo in policarbonato  
 per l'allenamento dei riflessi del portiere sui tiri  
 ravvicinati e deviati  
**dimensioni cm. 90x60 - peso kg. 5**  
 Football Wave - polycarbonate deviator  
 for training of GK reflexes on close and deflected shots  
 size 90x60 cm. - weight 5 kg.



**Bagna il Football Wave prima dell'uso  
 per incrementare la velocità della palla!**  
 Always wet your Football Wave  
 to increase ball speed!

**Più Football Waves possono essere posizionati  
 contemporaneamente sul terreno per ottenere  
 effetti imprevedibili**  
 You can place more than one Football Wave on the  
 pitch to get unpredictable deflections

**Inclinazione regolabile per mezzo  
 di due piedi telescopici**  
 Adjustable inclination by means of  
 two telescopic feet





## PROPRIOCEZIONE - Equilibrium training



**Art. 168PC**  
**Tavoletta propriocettiva in plastica su emisfera, Ø cm. 41 regolabile in altezza**  
 Plastic Equilibrium Board with hemisphere bottom side Ø 41 cm. adjustable height



**Art. 168PC**

pg.7

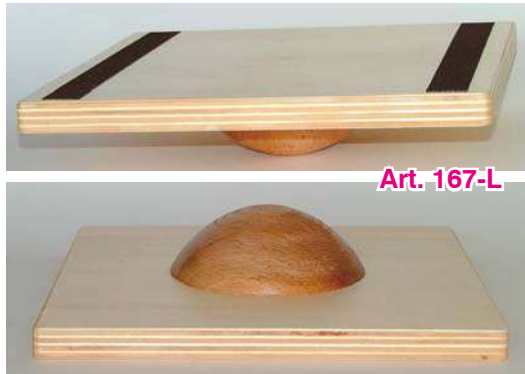

**Art. 167-L**

**Art. 167-L Tavoletta propriocettiva in legno su emisfera, base di appoggio cm. 30x30**  
 Wooden Equilibrium Board with hemisphere bottom side, base 30x30 cm.



**Art. IS441**  
**Tavoletta propriocettiva in legno su emisfera, con rivestimento antiscivolo Ø cm. 40**  
 Wooden Equilibrium Board with hemisphere bottom side, Ø 40 cm. base with anti-skid surface



**Art. 169-R**

**Art. 169-R Tavoletta propriocettiva in legno su semiluna, base di appoggio cm.60x40 con rivestimento in gomma antiscivolo**  
 Wooden Equilibrium Board, with half moon bottom side, base dimensions cm.60x40 with anti-skid surface

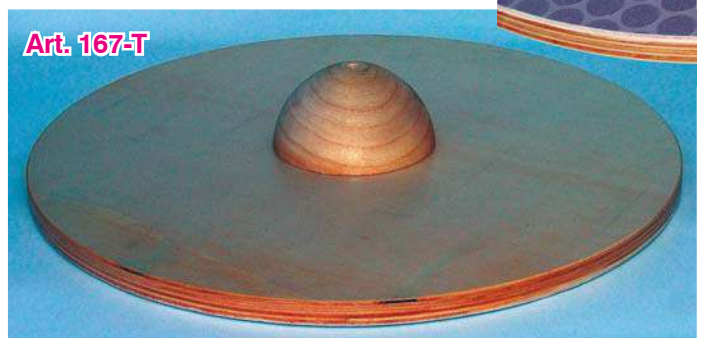

**Art. 167-T**

**Art. 167-T Tavoletta propriocettiva in legno su emisfera, Ø base di appoggio cm. 60 con rivestimento in gomma antiscivolo**  
 Wooden Equilibrium Board with hemisphere bottom side, base Ø 60 cm. with anti-skid surface



**Art. 169-V Tavoletta propriocettiva in vetroresina su semiluna, base di appoggio cm.60x40**  
 Fiberglass Equilibrium Board, with half moon bottom side, base dimensions 60x40 cm.



**Art. 167-V Tavoletta propriocettiva in vetroresina su emisfera, Ø base di appoggio cm. 60**  
 Fiberglass Equilibrium Board with hemisphere bottom side, base Ø 60 cm.





**Art. 995201** **PROPRIO FOOT**  
Tavoletta propriocettiva in legno situata su una superficie di appoggio gonfiabile  
Wooden Equilibrium Board with inflatable bottom side



**Art. 995212** **SOMBRERO**  
Tavoletta per ginnastica e riabilitazione che combina l'instabilità dell'imbottitura in gommapiuma sul piano di appoggio in legno con le proprietà di una semisfera gonfiabile  
Wooden Equilibrium Board with foam rubber on top and inflatable hemisphere on bottom side

pg.7



**Art. 995243** **ROLA BOLA** Tavola per l'allenamento dell'equilibrio con superficie antiscivolo - i fermi di sicurezza impediscono al cilindro di scivolare all'esterno  
Wooden Equilibrium Board with anti-skid on top  
The cylinder never slips out of the board thanks to the security wood pieces on bottom side



**Art. AIR.OC**  
Air step gonfiabile completo di maniglie con elastici (ad esaurimento scorte)  
Inflatable Air Step handles and elastics included (until available in stock)



**Art. TBEFS**  
BLOCCO PER STRETCHING tendineo e muscolare (flessori caviglia e coscia, dorso etc.) con appoggio soffice e sagomato a 2 inclinazioni ideale per il defaticamento e per il recupero  
STRETCHING BLOCK for ankle, leg, back muscles and tendons - with soft double inclination very good for after-training exercises

pg.8





**Art. MH9T / MH16T Semisfera gonfiabile Trial per riabilitazione e stimolazione propriocettiva diam. cm. 9 o cm. 16**  
Inflatable hemisphere for rehabilitation Ø 9 or 16 cm.



**Art. FTN-DB Cuscino gonfiabile puntinato Ø cm 32,5**  
Inflatable cylinder for rehabilitation Ø 32,5 cm.



**Art. FY8911 Cuscino gonfiabile puntinato Ø cm 39**  
Inflatable cylinder for rehabilitation Ø 39 cm.

pg.7



**Art. C1 Pedana Cilindrica gonfiabile Trial Skimmy per riabilitazione e stimolazione propriocettiva dim. cm.32,5x6**  
Inflatable cylinder for rehabilitation dim. 32,5x6 cm.



**Art. C2 Pedana Cilindrica gonfiabile Trial Super Skimmy per riabilitazione e stimolazione propriocettiva, dim. cm.40x9**  
Inflatable cylinder for rehabilitation dim. 40x9 cm.



**Resistenti ai tacchetti**  
Stud proof



**Art. C3 Pedana Trial Super Skimmy Professional con spalla rinforzata per riabilitazione e stimolazione propriocettiva, gonfiabile cm.40x9**  
Inflatable cylinder 40x9 cm. reinforced on sides







**Art. C11**  
**Pedana Rotante 1**  
 dim. cm 32,5x6  
 kg 2,8  
 (inclusa pompetta  
 per la gonfiatura)  
 Rotatory disk 1  
 pump included



**Art. C22**  
**Pedana Rotante 2**  
 dim. cm 40x10  
 kg 4  
 (inclusa pompetta  
 per la gonfiatura)  
 Rotatory disk 2  
 pump included



**Le Pedane Rotanti Trial, grazie al particolare meccanismo rotante, consentono di creare un'infinita varietà di esercizi basati su diverse posizioni di appoggio e modalità di movimento, utili a stimolare contemporaneamente il sistema vestibolare e quello visivo sensoriale, agendo quindi su tutti i sistemi di controllo del movimento sia a livello nervoso centrale che su quello spinale medio e periferico**

Rotatory Proprioceptive Disks Trial, given the particular rotating mechanism, allow a great variety of exercises based on different positions and motions, useful to simultaneously stimulate the vestibular and the sensory visual systems at both central and spinal/peripheral nervous levels

pg.7

**Art. C4**  
**Rebound Disk - diametro cm.40**  
**altezza cm.4 - Kg.1,5 colore rosso**  
 40 cm. diameter - 4 cm. thick - 1,5 Kg.

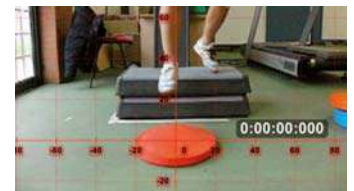

**Rebound Disk Trial è una nuova pedana ideale per allenare contemporaneamente la forza muscolare e la proprioccezione. È adatta sia all'uso indoor che outdoor, anche con scarpe tecniche munite di tacchetti. In particolare, con Rebound Disk è possibile sfruttare l'altezza per effettuare esercizi combinati pliometrici (cadute ed ammortizzamento con e senza rimbalzo) e propriocettivi, consentendo all'utente un'esperienza coordinativa e di potenziamento neuromuscolare notevole. Il salto, così come la corsa, è un elemento fondamentale in moltissimi sport come calcio, pallamano, beach-handball, basket, volley, e Rebound Disk è particolarmente allenante per il salto con arresto e cambio di direzione**

Rebound Disk Trial is a new tool ideal to simultaneously train muscle strength and proprioception. It's suitable both for indoor and outdoor utilization, even with technical shoes (with studs). In particular, with Rebound Disk it's possible to exploit one's height for plyometric exercises (fall and dampen with or without rebound) and for proprioceptive ones, and the user is enabled to experience a remarkable coordination and neuromuscular strengthening. Jumping, as well as running, is a basic element in many sports such as soccer, handball, beach-handball, basketball, volleyball, and Rebound Disk is very effective in training jump with stop and direction changes



**Art. T1 Medusa Trial - struttura instabile base Ø cm. 45  
altezza cm. 23 per riabilitazione e stimolazione  
equilibrio, in gomma doppio strato  
massima instabilità**

Medusa for rehabilitation  
and equilibrium training  
double stratum rubber  
Ø 45 cm. base  
height 23 cm.

**Resistente  
ai tacchetti  
Stud proof**

pg.8



**Art. T1.1  
Medusa Trial Ø cm.45  
altezza cm. 23  
con piatto rigido  
alla base  
per conferire  
maggiore stabilità**  
Medusa 45 cm. Ø base  
height 23 cm.  
with rigid bottom for  
better stability

**Resistente ai  
tacchetti  
Stud proof**

**Art. T3  
Pedana instabile  
con base inferiore  
antiscivolo  
Ø cm. 55  
altezza cm. 15  
studiata per  
i campi sintetici,  
specifica per  
i più giovani**  
Unstable Medusa  
with anti-skid bottom  
55 cm. Ø base  
height 15 cm.  
ideal for artificial  
grass and young  
players

pg.8



**Resistente  
ai tacchetti  
Stud proof**

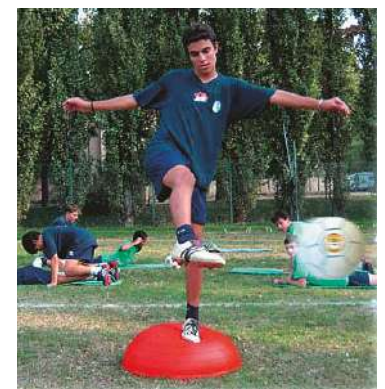

pg.8

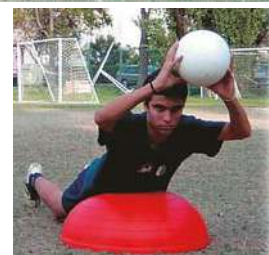

**Art. T2 Tartaruga Trial - struttura instabile base Ø cm. 65 altezza cm. 24  
per riabilitazione e stimolazione equilibrio, in gomma doppio strato**  
Medusa double stratum rubber Ø 65 cm. base height 24 cm. - for rehabilitation and equilibrium training



pg.7



**Art. AHF-170**  
**Pedana BOSU Ø cm.63 - h. cm.22**  
**ideale per fitness, yoga, pilates**  
 Bosu ball Ø 63 cm. - h. 22 cm.  
 ideal for fitness, yoga, pilates

pg.8



**Art. TCRAZY/TCR.T2**  
**CRAZY HORSE**  
**per allenamento**  
**di equilibrio "estremo"**  
**da effettuarsi in coppia**  
 For extreme balance training

pg.8



**Art. 14181**

**Fettuccia con lunghezza 18 metri per l'allenamento dell'equilibrio. Si fissa facilmente tra due alberi, ed è perfetta per giocare, allenarsi o fare riabilitazione. Kit completo con sacca e paraalberi**  
 18 meter long tape for balance training. It is easily fixed between two trees and is perfect for playing, training or rehab. Complete kit with bag and tree protections

**Art. TA-I Coppia tappeti propriocettivi ad isole a 2 densità diverse:**

**1 tappeto densità gr. 120 con isole densità gr. 30 - 1 tappeto densità gr. 30 con isole densità gr. 120**  
**dimensioni tappeti m.2x1 modulabili con velcro (a formare 1 materasso m.4x1 o m.2x2)**

Pair of Mats 2x1 meter each (when together 4x1 or 2x2 meter) :

1 mat 120 gr. density with 30 gr. density round areas, 1 mat 30 gr. density with 120 gr. density round areas

pg.8

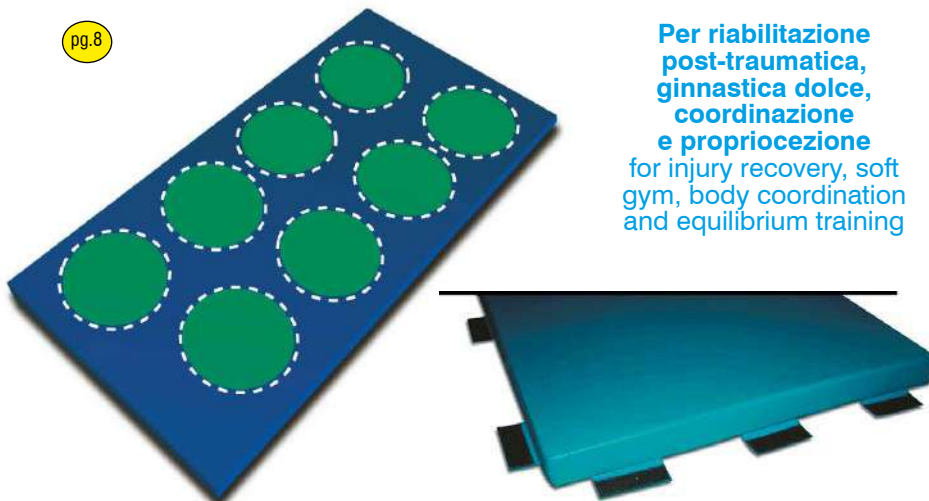

**Per riabilitazione post-traumatica, ginnastica dolce, coordinazione e proprioccezione**  
 for injury recovery, soft gym, body coordination and equilibrium training

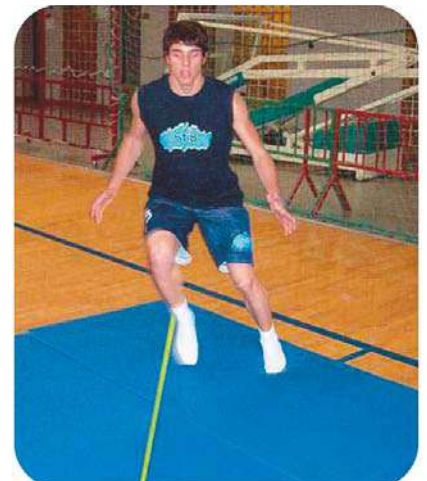





**Art. V9178**  
**Plinto per pliometria regolabile in altezza da cm. 30 a cm. 45 in tubolare di acciaio zincato piano di appoggio in legno multistrato dim. cm.150x30**  
 Plyometric bench adjustable heights (from 30 to 45 cm.) in galvanized steel wooden board dim. 150x30 cm.

pg.10

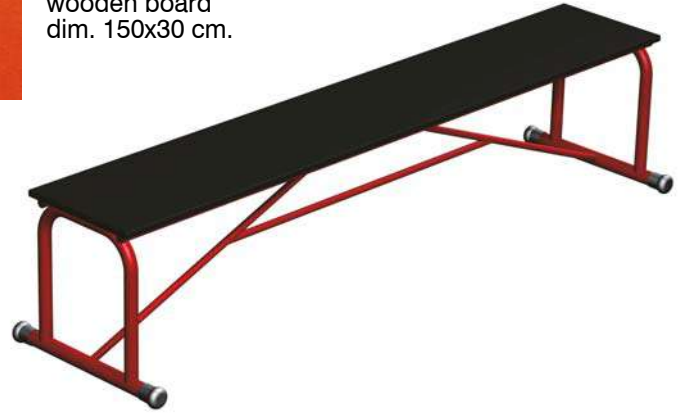

**Art. 1PP40/2PP40/3PP40/1PP50/2PP50/3PP50**  
**Panca per pliometria in acciaio verniciato, lunghezze disponibili: cm. 100 / cm. 200 / cm. 300 larghezza cm. 35 altezze disponibili: cm. 40 / cm. 50 piano di appoggio in legno rivestito in gomma antiscivolo**  
 Plyometric bench in painted steel, available length 100 / 200 / 300 cm. width 35 cm. available height 40 / 50 cm. board made of wood with anti-skid rubber cover



**Art. AHF-140**  
**Parallelepipedo per pliometria in legno cm. 76x61x51 utilizzabile a 3 diverse altezze**  
 Wooden plyometric box 76x61x51 cm. 3 different heights



**Art. AHF-164**  
**Parallelepipedo per pliometria in legno cm. 76x61x51 con imbottitura in EVA sp. cm. 2 utilizzabile a 3 diverse altezze**  
 Wooden plyometric box 76x61x51 cm. EVA padding 2 cm. thickness 3 different heights



**Art. VCU60 / VCU70 / VCU80**  
**Cubo per pliometria in legno verniciato al naturale con gomma antiscivolo sui piani di appoggio lato cm. 60/70/80**  
 Wooden plyometric cube with anti-skid rubber 60/70/80 cm. side



**Art. PAV2** Set 3 plinti soft a basi rettangolari, sovrapponibili - 3 altezze ottenibili: cm. 30, 60, 90 in gommapiuma rivestita con PVC ignifugo Cl. 1  
 Set of 3 rectangular base soft steps - by placing them one upon the other you can get 3 different heights: 30, 60, 90 cm.



## TRAMPOLINI - Trampolines



**Art. 166**  
Trampolino elastico Ø cm. 97  
Trampoline Ø 97 cm.



**Art. TF-03**  
Trampolino elastico Ø cm. 122  
pieghevole - 40 molle  
Trampoline Ø 122 cm.  
foldable - 40 springs

pg.7

**Art. V1709**  
Trampolino elastico  
ad altezza fissa  
dim. cm.125x125  
Trampoline 125x125 cm.  
reinforced



**Art. S01154**  
Trampolino elastico  
ad inclinazione  
regolabile  
completo di protezioni  
dim. cm. 125x125  
Trampoline  
size 125 x 125 cm.  
adjustable inclination  
with soft perimetric  
protection

**Art. TRO-9**  
Trampolino da esterno Ø cm. 305  
con rete di protezione perimetrale  
Outdoor trampoline cm. 305 diameter  
with perimetric protection net





## SCALE - CERCHI - CORDE - Speed Ladders - Hoops - Jumping Ropes

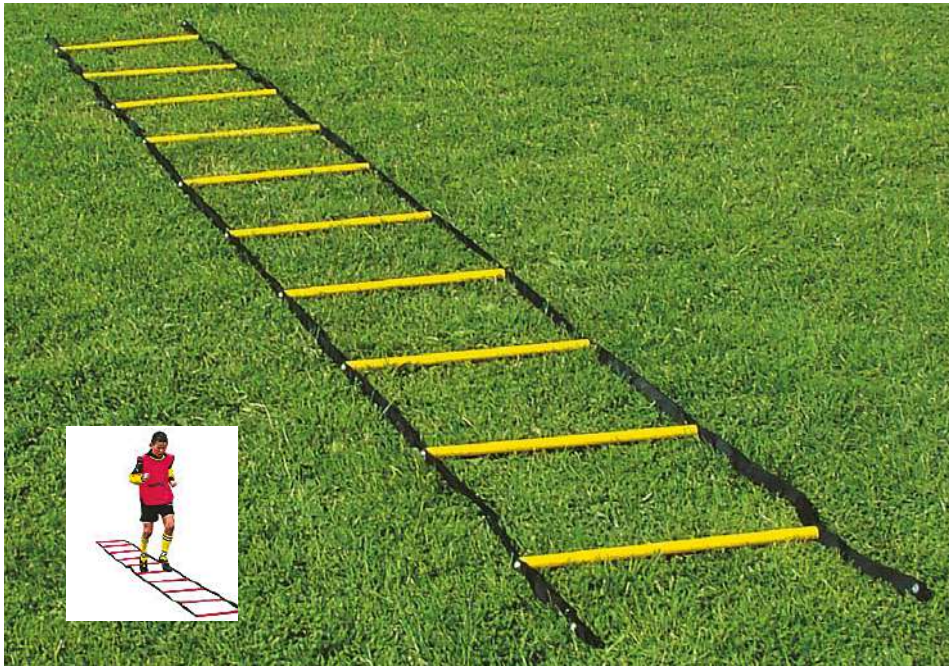

### Art. SL4

**Scala lunghezza m. 4 con 10 pioli rotondi per esercizi di coordinazione motoria (compresa sacca per il trasporto)**

Speed ladder length 4 meters with 10 tubular rungs for quick step and coordination exercises, bag included

pg.9



### Art. SL4LP

**Scala lunghezza m. 4 con 8 listelli piatti a distanza regolabile per esercizi di coordinazione motoria (compresa sacca per il trasporto)**

Speed ladder length 4 meters with 8 adjustable flat rungs for quick step and coordination exercises, bag included



### Art. SL6

**Scala lunghezza m. 6 con 12 listelli piatti a distanza regolabile (compresa sacca per il trasporto)**

Speed ladder length 6 meters with 12 adjustable flat rungs, bag included



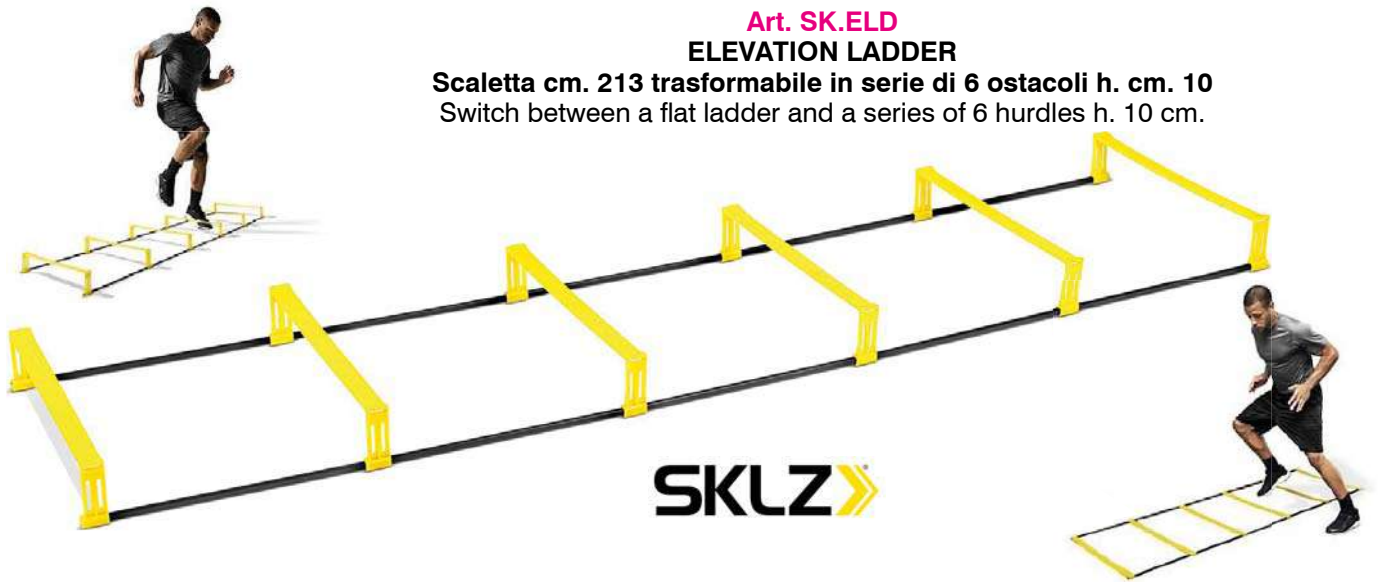

**Art. SK.ELD**

**ELEVATION LADDER**

**Scaletta cm. 213 trasformabile in serie di 6 ostacoli h. cm. 10**  
Switch between a flat ladder and a series of 6 hurdles h. 10 cm.

pg.9



**Art. B706353**

**Scala in plastica flessibile lunghezza m.4 con 10 pioli spessore cm.1,5**  
**dimensione quadri cm.40x40 pieghevole con rimessaggio**  
Flexible speed ladder length 4 meters in plastic pipes 1,5 cm.  
thick - foldable with holder



**Art. 701411**

**Minibirillo**

**concavo altezza cm. 9**  
**per sollevamento**  
**scala Art. 708241**

Cone 9 cm. height carved on  
top for Art. 708241  
underneath support

**Art. K4111**

**Kit scala Art. 708241**

**+ 20 Minibirilli Art. 701411**

Kit Art. 708241 + 20 x Art. 701411



**Art. 995215**

**Cor Web da 36 quadri cm. 35x35**  
**dimensioni totali cm. 465x120**  
**composto da 13 stecche gialle semirigide**  
**e 4 strisce in cinghia rossa**

Speed ladder 36 squares 35x35 cm. each  
overall dimensions 465x120 cm.

**Art. 995216**

**Borsa per Cor Web in nylon con cordino e**  
**stopper per chiusura, con maniglia per il trasporto**  
Bag for Cor Web 36 squares



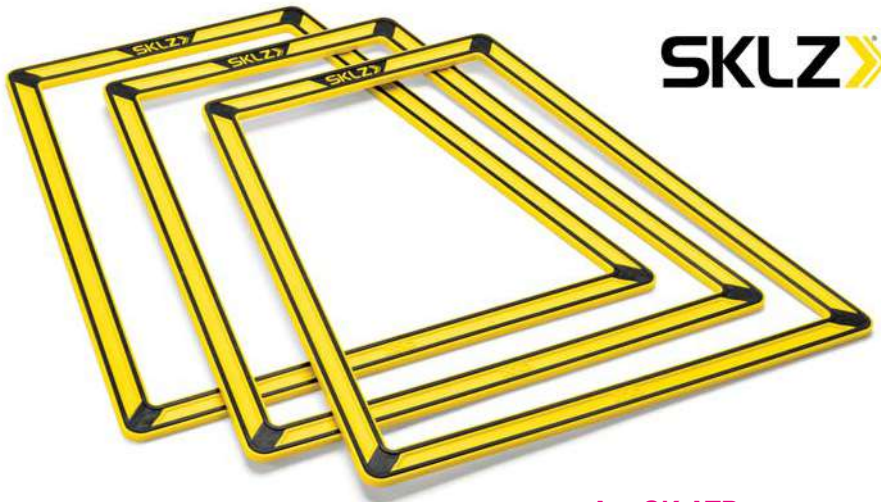

**SKLZ**

**Esempi di combinazioni possibili**  
A few examples

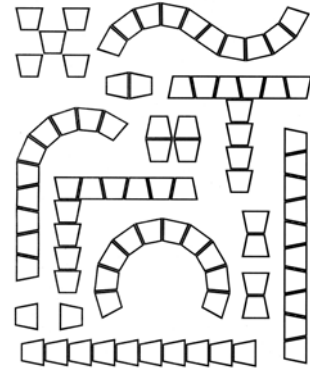

**Art. SK.ATP**  
**AGILITY TRAINER PRO - set 10 TRAPEZI componibili per allenamento agilità e coordinazione multidirezionale, e per il miglioramento della velocità e dei tempi di reazione**

Agility Trainer Pro - customizable footwork and agility trainer designed for curvilinear and alternative training patterns, cuts your reaction time while adding speed in all directions. Set of 10 trapezoids with a carry handle



Con questo nuovo strumento di allenamento creativo si possono incrementare le doti di rapidità, agilità e potenza nei cambi di direzione e nelle traiettorie curvilinee che gli atleti sono chiamati ad effettuare durante la gara.

Questi speciali trapezi sono molto stabili su ogni tipo di terreno, permettendo così un esercizio senza interruzioni



pg.9



Sports don't happen in a straight line, now neither does your training.

The Agility Trainer Pro lets you recreate the curvilinear and broken patterns that take place in sports, helping you set up your cuts, turns and changes of direction. It lets you add the multi-directional quickness and precise footwork that can quickly change the game.

The Agility Trainer Pro won't slip, slide or otherwise interrupt your training sessions

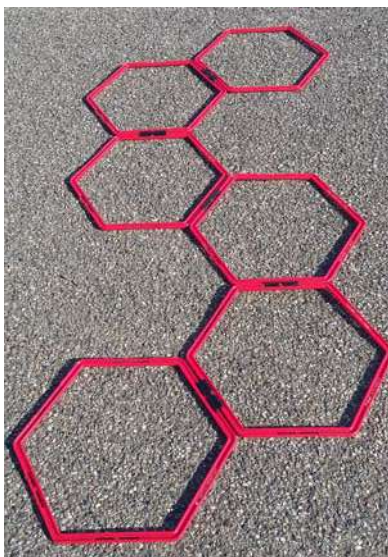

**Art. HEXS6 Set 6 esagoni in plastica componibili dim. cm.45x53 (altezza, larghezza) lato cm.28, completi di clip e borsa colori: giallo, verde, rosso, arancio, azzurro**

Set of 6 modular plastic hexagons 45x53 cm. (height, width) complete with clips and bag - colors: yellow, green, red, orange, royal





**Art. SQ15.NS**  
**Set 6 elastici con velcro di ricambio**  
Set of 6 spare elastics with velcro



**Art. SQ15**  
**15 SQUARES**  
Telaio di cm. 300x200 in alluminio Ø mm.32  
6 elastici con velcro consentono di formare 15 quadri per esercizi di coordinazione, reattività, riscaldamento e potenziamento muscolare con piedi di sostegno intercambiabili utilizzabile alle seguenti altezze dal terreno: cm.0 / cm.20 / cm.40 / cm.60  
kit completo di borsa per il trasporto e di 6 elastici di ricambio (che consentono eventualmente di formare un numero maggiore di quadri)  
Aluminium frame 300x200 cm. pipe Ø 32 mm. equipped with 6 elastic bands with velcro forming 15 squares for warm up, coordination, reactivity and jumping exercises with interchangeable sets of support feet adjustable at the following heights from ground: 0 cm. / 20 cm. / 40 cm./ 60 cm. with carrying bag and 6 additional spare elastics (which eventually allow you to form a greater number of squares)

pg.9

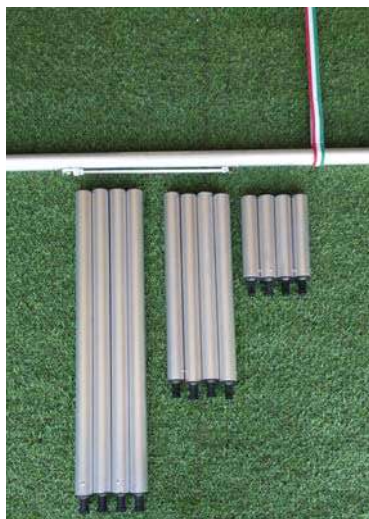

**Morbidi elastici flessibili fino a terra**  
Soft elastic bands flexible down to the ground



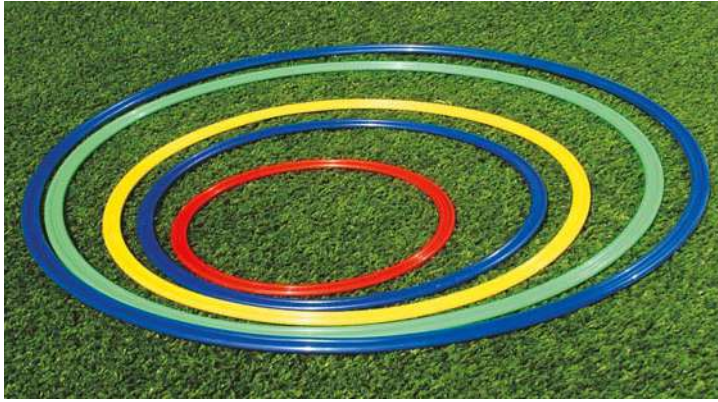

**Art. CNP30 / CNP40 / CNP50 / P00181 / P00191 / P00201**  
**Cerchio in nylon piatto Ø cm. 30 / 40 / 50 / 60 / 70 / 80**  
 Flat Nylon Hoop Ø 30 / 40 / 50 / 60 / 70 / 80 cm.  
**4 colori - 4 colors**



**Art. P00182 / P00192 / P00202 / P00212**  
**Cerchio in PVC tubolare**  
**Ø cm. 60 / 70 / 80 / 90 colore rosso o giallo**  
 Tubular PVC hoop  
 Ø 60 / 70 / 80 / 90 cm. red or yellow color



**Art. S00402/S00405/  
 S00406/E21**  
**Bastone in legno o  
 PVC cm. 80 - 100 - 120**  
 Wooden and PVC Stick  
 80 - 100 - 120 cm.



**Art. OCC11**  
**Connettore per  
 cerchi piatti**  
 Flat Hoop Connector



**Art. S00472**  
**Mensola porta cerchi a parete in  
 acciaio verniciato**  
 Hoop wall Holder in painted steel

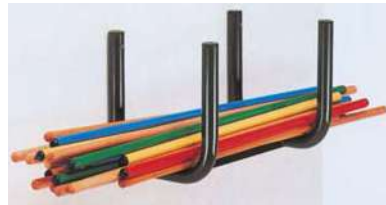

**Art. S00414**  
**Mensola porta bastoni a parete  
 in acciaio verniciato**  
 Stick wall Holder in painted steel

pg.8

**Art. 043P**  
**Corda per salto in nylon  
 con manici in legno**  
 Nylon Skipping Rope with  
 hardwood handles



**Art. 043**  
**Corda per salto in canapa con manici  
 in legno ed ingrossamento centrale**  
 Hemp Skipping Rope with hardwood  
 handles, thicker in the middle section



**Art. AHF-017**  
**Corda per salto in PVC con  
 manici soft touch e cusci-  
 netti a sfera**  
 PVC Skipping Rope with soft  
 handles and ball bearings



**Art. CS1**  
**Corda per salto in canapa con ingrossamento  
 centrale (senza manici)**  
 Hemp Skipping Rope thicker in the middle without handles

**Art. AHF-102**  
**Corda per salto veloce in acciaio  
 con manici in plastica e cuscinetti  
 a sfera (lunghezza regolabile)**  
 Steel Skipping Rope with plastic  
 handles and ball bearings  
 (adjustable length)



**Art. 043L Corda per  
 salto in pelle**  
 Leather Skipping Rope  
 with hardwood handles

**New!**





**Art. STAR**  
**Starkick completo di cintura e corda elastica per allenamento ai palleggi ed al tocco di palla (pallone escluso)**  
 Starkick with belt and elastic rope for ball kick and control training (ball not included)



**Art. PTI.15070**  
**Soccer Ball Trainer completo di pallone, corda elastica di m. 12,5 e ancoraggio**  
 Soccer Ball Trainer with ball size 5 in TPU, rubber base, 12,5 m. elastic rope and 1 peg

pg.9



**Art. OTK**  
**Training Kicker con corda non elastica per allenamento ai palleggi ed al tocco di palla (pallone escluso)**  
 Training Kicker with non elastic rope for ball kick and control training (ball not included)



Uno strumento innovativo per migliorare la tecnica di esecuzione e la potenza del contrasto. Il Tacke Improver indirizza il piede d'appoggio verso la posizione più idonea per esprimere la maggiore potenza d'impatto. Potenzia inoltre tutte le catene muscolari che intervengono nel contrasto, ma senza causare traumi, grazie ad una speciale molla collegata al pistone che sorregge il pallone.

*Very useful training device for strengthening all muscles involved in tackling. Absolutely safe, thanks to a spring and piston system that avoids injuries.*



pg.9



**Art. CVCO**  
**Cavigliera Coordinativa con contrappeso, migliora l'equilibrio e l'indipendenza psicomotoria delle gambe, ed in particolare ammorbidisce la gamba dominante migliorandone la sensibilità del piede**  
 Rotating ankle, with weight, to improve equilibrium and leg independence: in particular it softens the dominant leg improving sensibility of the non dominant foot



pg.9

**Video dimostrativo disponibile su [www.barretsport.com](http://www.barretsport.com)**  
**Video available at [www.barretsport.com](http://www.barretsport.com)**



## ALLENAMENTO SOTTO CARICO E FUNZIONALE - Training with weights



Art. SLD



Art. ASN

Cintura in pelle sintetica con velcro completa di corda, catena e moschettoni di ricambio per slitta Art. SLD  
Synthetic leather belt, rope and chains spare for Art. SLD

**Art. SLD** Slitta per il miglioramento della capacità di accelerazione tramite il traino a carico variabile completa di cintura in pelle sintetica con velcro, corda e moschettoni (dischi in ghisa non inclusi)  
Sledge (weights not included) improving acceleration with synthetic leather belt, rope and chains

Art. CBV

Cintura in pelle sintetica con velcro di ricambio per Art. SLD  
Synthetic leather belt w/velcro spare for Art. SLD



pg.9



In dotazione 3 sacchi di capacità Kg. 4,5 da riempire con sabbia  
Includes 3 x 4,5 Kg. sacs to be filled with sand



**Art. SK.SPSC**  
**SPEED SAC - sacca di traino con pesi munita di cintura e moschettone utilizzabile anche indoor o su superfici sintetiche**  
Improves overall speed and explosiveness, boosts acceleration and stride length. Adjustable weight options for variable resistance portable and versatile to be used anywhere

pg.8



Art. 045

**Giubbino caricabile con pesi fino a Kg.10 (pesi inclusi)**  
Jacket Weighted up to 10 Kg. (weights included)



pg.9

**Art. PCH**  
**Paracadute per potenziamento della corsa**  
Parachute to improve the power of your run





**Art. 991310/991311/991312**  
**Shoulder Bag**  
**con 3 maniglie**  
**pesi disponibili**  
**Kg. 10/15/20**  
Shoulder Bag with  
3 handles  
weights available  
10/15/20 Kg.

pg.8

**New!**



**Art. TBB2 / ... / TBB6**  
**Body Bar**  
**Kg. 2-3-4-5-6 per**  
**allenamento funzionale**  
**con pesi liberi**  
Body Bar  
2-3-4-5-6 Kg.  
for functional training  
with free weights

pg.12



**Art. PBG-5N/PBG-10N/PBG-15N**  
**PBG-20N/PBG-25N**  
**Borsa Zavorrata**  
**con 6 impugnature**  
**pesi disponibili Kg.5-10-15-20-25**  
Heavy Bag with 6 handles  
weights available 5-10-15-20-25 Kg.

pg.8

pg.9

**Art. BGZ**  
**Borsa Gonfiabile zavorrata con acqua (a peso variabile)**  
**cm. 85 con 4 maniglie - consente nuovi esercizi di forza**  
**coordinata grazie alla massa oscillante interna**  
Inflatable Bag with water inside, length cm. 85 with 4 handles  
allows new exercises for muscle strength thanks to the dynamic  
weight inside



**Art. V5083**  
**Pedana di salto in tubo in acciaio dim. cm. 100x100**  
**con elastico rigido a tensionamento uniforme**  
**e dinamometro, cintura e moschettoni**  
**(dischi in ghisa non inclusi)**  
Jump Platform in painted steel dim. 100x100 cm.  
with elastic rope and dynamometer, belt and snap-hooks  
(weights not included)

pg.9



**Art. BR-3812 / BR-5015**  
**Fune da allenamento**  
**Battle Rope**  
**ø mm 38 lunghezza mt. 12**  
**oppure**  
**ø mm 50 lunghezza mt. 15**  
Battle Rope  
12 meters - 38 mm. thick or  
15 meters - 50 mm. thick

pg.9



**In poliestere intrecciato con impugnature rivestite in gomma termoretraibile**  
**ideale per il potenziamento dei muscoli di spalle e avambracci,**  
**ottimo allenamento cardiorespiratorio**  
Polyester encased rope with shrink-wrap handles, perfect for strengthening shoulders  
and forearm muscles, excellent cardio-respiratory workout



## FUNCTIONAL TRAINING



pg.9

**FT.IST**  
**Functional Training**  
**Attrezzo polifunzionale**  
**per il potenziamento della catena estensoria**  
**e flessoria degli arti superiori e inferiori**  
 Functional Training multi-purpose  
 belt for the enhancement  
 of the extension and flexion muscular  
 chains of the upper  
 and lower limbs



**FST-DBL**  
**Functional Training Double Pro**  
**Attrezzo professionale per allenamento**  
**in sospensione con maniglie svincolate**  
**utilizzabili separatamente**  
 Functional Training with free handles to be used also  
 separately - steel snap hooks and rings



**MTLTX**  
**Lacci di Trazione**  
 Traction Laces

pg.9

**PLTRZ**  
**Prolunga**  
**per Lacci**  
**di Trazione**  
 Extension for  
 Traction Laces



**Attrezzo polifunzionale per il potenziamento della catena estensoria e flessoria degli arti superiori e inferiori**  
 Multi-purpose belt for the enhancement of the extension and flexion muscular chains of the upper and lower limbs



**Art. DTL15**  
**Lacci di Trazione**  
**dinamici**  
**con carrucola**  
 Dynamic functional  
 training with pulley



## BANDE ELASTICHE - BOA - Elastic Bands



**Art. IFBG**  
Fitness band colore giallo  
yellow  
cm. 175x15

**Art. IFBR**  
Fitness band colore rosso  
red  
cm. 175x15

**Art. IFBB**  
Fitness band colore blu  
blue  
cm. 175x15

**Art. IFBN**  
Fitness band colore nero  
black  
cm. 175x15



**Art. 991707 / 991708 / 991709**  
**SET 10 ELASTICI AD ANELLO**  
colore giallo (morbido) - rosso (medio)  
verde (resistente) Ø cm. 27,50  
Elastic Rings yellow (soft) - red (medium)  
green (hard) 27,5 cm. Ø



**Art. AHF-141**  
**Coppia maniglie per fitness band**  
Pair of handles for fitness band

pg.11

**Art. AHF-251/AHF-128/AHF-129**  
**AHF-130/AHF-131/AHF-132**

**Elastico ad anello POWER BAND**  
circonferenza cm. 208 spessore mm. 4,5  
larghezza giallo mm. 6,4 - rosso mm. 13 - nero mm. 22  
viola mm. 29 - verde mm. 45 - blu mm. 64  
Power Band elastic circumference cm.208 - 4,5 mm. thick  
yellow 6,4 mm. width - red 13 mm. width  
black 22 mm. width - violet 29 mm. width  
green 45 mm. width - blue 64 mm. width



**Art. RLER**  
**Rotolo lattice rosso per esercizi muscolari,**  
larghezza cm. 15, lunghezza m. 25  
spessore 0,4 mm.  
Elastic red Band for muscle exercises,  
15 cm. wide, 25 meter long, thick 0,4 mm.

pg.11



**Art. RLEF**  
**Rotolo lattice fucsia per esercizi muscolari,**  
larghezza cm. 15, lunghezza m. 25  
spessore 0,3 mm.  
Elastic fuchsia Band for muscle exercises,  
15 cm. wide, 25 meter long, thick 0,3 mm.



**Art. RLEB**  
**Rotolo lattice blu per esercizi muscolari,**  
larghezza cm. 15, lunghezza m. 25  
spessore 0,5 mm.  
Elastic blue Band for muscle exercises,  
15 cm. wide, 25 meter long, thick 0,5 mm.



**Art. AHF-068**  
**Set 3 elastici tubing con maniglie**  
tre differenti livelli di resistenza  
impugnature ergonomiche soft touch  
per esercizi arti superiori e inferiori  
completo di borsa in microrete  
Set 3 elastics with handles  
3-level resistance - soft touch handles,  
bag included - tones and strengthens  
arms, legs, gluteus, abdominals,  
shoulders and chest muscles





**Art. KER-IS**

Set 5 elastici con 5 diverse resistenze dotati di ganci metallici da entrambi i lati. Completo di 1 coppia di maniglie, 1 coppia di cavigliere, 1 accessorio per bloccare l'elastico contro una porta e utilizzare un arto per volta, 1 sacca  
 Set of 5 elastic bands with 5 different resistances equipped with metal hooks on both sides. Complete with 1 pair of handles, 1 pair of ankle bands, 1 accessory to lock the elastic against a door and use one limb at a time, 1 bag

Here are some examples of the door anchor in action:

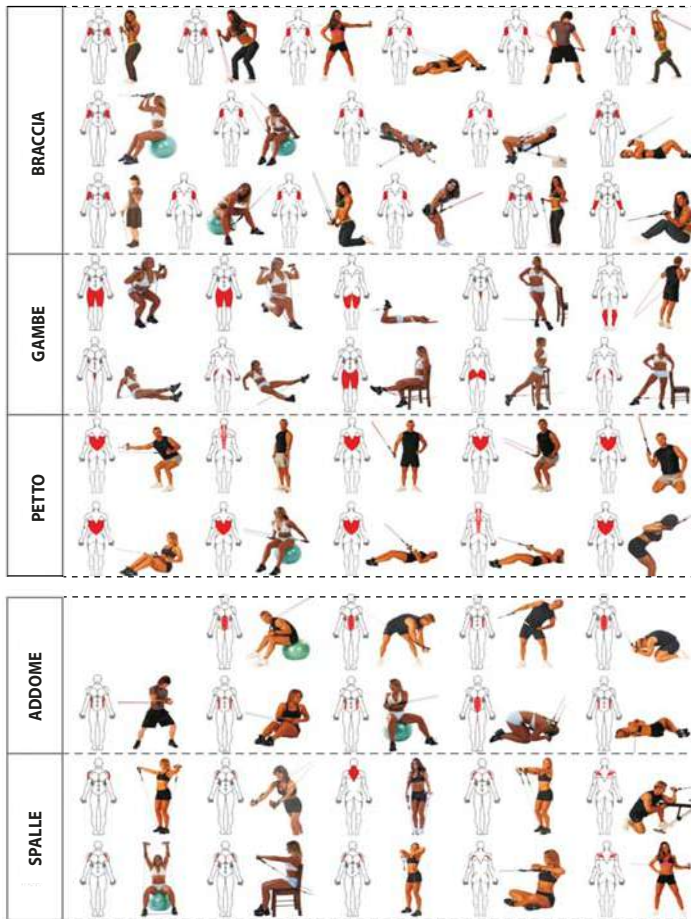

COLORE ELASTICO	LIVELLO DI RESISTENZA	LIVELLO DI RESISTENZA	DIMENSIONI
GIALLO	EXTRA LEGGERO	2,7 kg - 3,6 Kg	5X8X1100MM
VERDE	LEGGERO	4 kg - 5 Kg	6X9X1100MM
ROSSO	MEDIO	5,5 kg - 6,75 Kg	5X9X1100MM
BLU	FORTE	6,75 kg - 9 Kg	5X10X1100MM
NERO	EXTRA FORTE	9,45 kg - 11,25 Kg	6X11X1100MM

1. Your resistance bands come in 5 different resistance levels, noted by a different band color. Please refer to the table for more information on the levels of resistance
2. You can use any or all of the bands at one time during your workouts
3. Attach one end of the band(s) to the foam handles or ankle straps and same on the other end
4. The door anchor will attach anywhere on a standard door, including the bottom of the door. To use the door anchor, ensure the bigger end is attached to the apposite side of door and feed the thin end through. Once the thin end is through you can feed the exercise band through it. Ensure the door is fully closed before performing any exercise

pg.11

Resistance Band Color	Resistance level	Resistance level	Dimensions
Yellow	X- Light	6lbs - 8lbs	5X8X1100MM
Green	Light	9lbs - 11lbs	6X9X1100MM
Red	Medium	12lbs - 15lbs	5X9X1100MM
Blue	Heavy	15lbs - 20lbs	5X10X1100MM
Black	X-Heavy	21lbs - 25lbs	6X11X1100MM

**Art. 991710/ ... /991738**

Elastico tubing con maniglie colore rosso, giallo, viola, nero  
 Elastic with handles red, yellow, violet, black color



**Art. 991714/ ... /991742**  
 Elastico tubing mt.10 senza maniglie colore rosso, giallo, viola, nero  
 10 meter elastic without handles red, yellow, violet, black color



**Art. 016824**

**ELASTICO BOA in gomma para mm. 7x18 rivestito con guaina di sicurezza lunghezza mt. 3 con un moschettone a ciascuna estremità, resistenza Kg. 30**

Rubber BOA 7x18 mm. with safety sheath 3 meter length, resistance 30 Kg.

pg.11



**Art. 016827**  
**Paio polsini per elastico BOA**  
Pair of wristbands for BOA exercises

Si suggerisce l'utilizzo dell'elastico BOA con una cintura o con un altro tra gli accessori disponibili

Utilization of rubber Boa is suggested with a belt or with another available accessory



**Art. 016828**  
**Paio cavaliere per elastico BOA**  
Pair of anklebands for BOA exercises

**Art. 016825**

**CINTURA Junior da agganciare a elastico BOA diametro max cm.105**

Junior Belt for BOA traction - max diameter 105 cm.

**Art. 016826**

**CINTURA Senior da agganciare a elastico BOA diametro max cm.140**

Senior Belt for BOA traction - max diameter 140 cm.

pg.11



**Art. 016829**  
**Pettorina per elastico BOA**  
Shoulder belt for BOA exercises



**Art. C3005**  
**Staffa per ancoraggio elastico BOA a parete**  
BOA wall anchor bracket



**Anello scorrevole "free-floating" ring**



**SKLZ**

pg.11

**DYNAMIC RESISTANCE / ASSISTANCE TRAINER**



**Art. SK.R360**

**RECOIL 360 - elastico con cintura ad anello scorrevole utilizzabile in autonomia o con l'aiuto del preparatore**

Maximizes power, speed and vertical jump

Engineered with a "free-floating" ring

for 360 degrees of movement

Designed for solo use or for training with a partner





**Art. SK.ACTR**

**ACCELERATION TRAINER**

per l'allenamento della velocità in ogni direzione,  
dell'accelerazione e della velocità massima  
Da utilizzare con l'aiuto del preparatore

Trains speed in every direction  
Builds speed and power from the start,  
during acceleration and at the top-end  
Designed for training with a partner



pg.10

**DYNAMIC OVERLOAD AND RELEASE SYSTEM**



Anello scorrevole  
"free-floating" ring



**Art. SK.LRP**

**LATERAL RESISTOR PRO**

Attrezzo per migliorare la velocità del primo passo  
e la rapidità laterale con elastici tubolari  
intercambiabili a diversa resistenza

Develops first-step quickness and lateral speed  
Patented Slide-Lock system for quick, safe  
switching of resistance cables



**STRENGTH AND SPEED TRAINER**



pg.10

**VERTICAL JUMP TRAINER**



**Art. SK.HPZ**

**HOPZ 2.0**

Attrezzo per migliorare la forza e la potenza dei muscoli  
impegnati nell'elevazione, con elastici tubolari  
intercambiabili a diversa resistenza

Builds explosive leg power and strengthens jumping muscles  
You can move resistance cables on belt to target specific  
muscles and change resistance cable quickly





pg.10



**Art. AKHF**

**Kit Home Fitness comprendente rinforza spalle, sistema carrucolare, bastone estensibile, Antonelest uomo, Antonelest donna**  
 Kit includes shoulder strengthener, extensible stick, Antonelest for man and Antonelest for woman

**Art. ARS.3 Banda Elastica rinforza spalle - può essere usata in ogni luogo che abbia un appiglio per la chiusura a velcro (anche in casa o in albergo) grazie alla presenza di uno spessore che, a porta chiusa, non fa scivolare l'attrezzo e non danneggia la porta**  
 Elastic Band for shoulder injury training exercises

pg.11



**Art. 995238V/995239V/995240V**

**Barra in alluminio con bande elastiche gialle (soft)/blu (medium)/verdi (hard) impugnature in neoprene e maniglie morbide**  
 Aluminium Bar with yellow (soft)/blue (medium)/green (hard) elastic bands, neoprene soft handles



**Art. PTI.SPS**

**Slide Pads - paio di slide pads utilizzati per esercizi di scivolamento di mani e piedi volti al miglioramento della flessibilità e della forza muscolare**  
 Set of 2 pcs. - simulates many slide board exercises - conditioning tool to improve flexibility, shaping and core strength



pg.11



**Art. PTI.STR**

**Slide Trainer - lunghezza cm.140 con 2 scarpette con velcro per lo scivolamento**  
 Utile strumento per sviluppare la forza laterale, la potenza, la resistenza, l'equilibrio, l'agilità, la velocità e la flessibilità  
 Slide Trainer length 140 cm. with 2 gliding shoes great for developing lateral strength, power, endurance, balance, agility, speed and flexibility





**Art. 05021456**

**JUMP-TRAINER**

**Strumento di allenamento per migliorare la potenza nel salto. Adatto a portieri e giocatori. Un atleta indossa la cintura regolabile con velcro, mentre due compagni di allenamento trattengono le fasce elastiche salde a terra - lunghezza delle fasce elastiche m. 1,20 ciascuna (in posizione di riposo)**

Training tool to improve jump power. Suitable for goalkeepers and field players. One player puts on the adjustable hip belt with velcro fastener, two training partners hold the elastic bands on the ground using their feet. Length of elastic side bands (not stretched) 1,20 m.

**New!**

pg.10



**Art. 05021320**

**GOALKEEPER TRACTION BELT**

**Cintura con elastici intercambiabili per allenamento del portiere. Modificando la composizione degli elastici fissati alla base dei pali si ottengono 8 diversi tipi di resistenza (leggera, media, medio-alta, alta)**

Belt with elastics for goalkeeper training.

By switching bungee ropes and connecting them to each other and to the belt in different ways, you get 8 different combinations for low, medium, medium-high, high resistance



**New!**



**Art. KAP**

**Kit allenamento portiere composto da 10 Antonelast, 1 Cintura, 1 Rinforza adduttori, 4 Anelli fissa bande per il miglioramento della forza esplosiva**

Goalkeeper training kit

made of 10 Antonelast, 1 Belt, 1 Abductor muscle band, 4 connecting rings to improve explosive muscular strength and goalkeeper's jumps and dives

pg.10





**Art. AE**  
**Banda elastica**  
**Antonelast**  
**per esercizi di**  
**stretching e**  
**potenziamento**  
**muscolare**  
 Elastic band for  
 body muscle  
 exercises



**Con velcro cucito su**  
**entrambe le estremità**  
**with velcro seamed at**  
**both sides**



**Art. RA**  
**Rinforza abduttori**  
 Elastic band for  
 abductor muscles

**Con velcro cucito su**  
**entrambe le estremità**  
**with velcro seamed at**  
**both sides**



pg.10



**Art. OSI**  
**Over Speed Improver - Tramite questa cintura elastica l'atleta più veloce trascina il più lento,**  
**incrementando contemporaneamente la velocità di entrambi**  
 By this elastic belt the quicker player pulls the slower player, increasing both athletes' speed



**Con velcro cucito su**  
**entrambe le estremità**  
**with velcro seamed at**  
**both sides**



**Art. PSR**  
**Power Speed**  
**Resistor**  
**per potenziamento**  
**della corsa**  
**esercizio in coppia**  
**(nylon non elastico)**  
 To improve explosive  
 force - two people  
 involved (non elastic  
 band)



**Art. EPW**  
**Elastic Power**  
**2 fasce con cintura**  
**in pelle**  
**incrementa**  
**la forza esplosiva**  
**potenziando la**  
**muscolatura delle**  
**gambe e del dorso**  
 2 Bands with leather belt  
 for explosive strength  
 improvement, for leg and  
 back muscle training





**Art. SRE**

**Speed Reaction**

**Allenamento dei riflessi e della reattività (l'elastico non si sgancia se il difensore perde contatto dall'attaccante)**

Reflex and reactivity training device (the belt does not separate if the defender loses contact)



**Cintura elastica**  
Elastic belt



**Cintura non elastica**  
Non elastic belt

**Art. EB**

**Evasion Belt - Allenamento dei riflessi e della reattività ideale per marcature a uomo (la cintura si sgancia se il difensore perde contatto dall'attaccante)**

Reflex and reactivity training device, for man to man coverage (the defender loses contact)



**Art. RIM**

**Reaction Improver**

**per l'allenamento della reazione allo stimolo visivo in percorsi ad ostacoli, ideale per marcature a uomo**

**(l'elastico si stacca se si perde contatto)**

Elastic Belt for visual reflex training in drill sections, for man to man coverage (the elastic separates if following athlete loses contact)



pg.10



**Art. KAT Kit allenamento tattico composto da 7 bande elastiche di metri 10 cadauna**  
Tactical training Kit made of 7 Elastic bands 10 meter long each

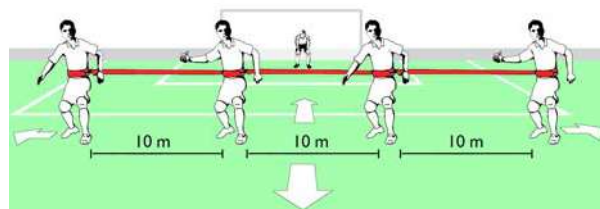
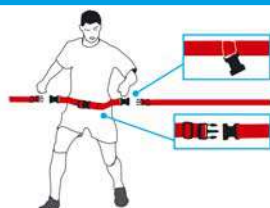

**New!**

**Art. 05020798**

**Set di 4 cinture con dispositivo di fissaggio e 3 fasce non elastiche lunghe m. 10 ciascuna**

**Con questo prodotto è possibile vincolare quattro difensori allenandone il posizionamento ed i movimenti sul campo**

Set of 4 hip belts with fasteners and 3 unelastic bands 10 m. long each  
With this kit you can connect all four players of your defensive block, training their positioning and movements on the field



**Art. SC010**

**OFFERTA KIT TECNICO SCUOLA CALCIO**

pg.9

Kit così composto: n.15 Paletti slalom Art.007

- n. 15 basi ad imbuto Art.018 - n. 1 kit delimitatori Art.016 - n. 6 ostacoli over cm.12 Art.80.12
- n. 2 ostacoli over cm.20 Art.80.20 - n. 2 ostacoli over cm.30 Art. 80.30 - n. 2 ostacoli over cm.40 Art.80.40
- n. 12 corde salto Art.043P - n. 1 Scala a pioli Art. SL4 - n. 12 Maxidelimitatori h.cm.28 Art.019.1
- n. 12 cerchi piatti diam.cm.50 Art.CNP50 - n. 1 Tavoletta propriocettiva in ABS Art.168PC

**SOCCER SCHOOL KIT SPECIAL OFFER**

15 x Art.007 + 15 x Art.018 + 1 x Art.016 + 6 x Art.80.12 + 2 x Art.80.20 + 2 x Art.80.30 + 2 x Art.80.40 + 12 x Art.043P + 1 x Art.SL4 + 12(pieces) x Art.019.1 + 12 x Art.CNP50 + 1 x Art.168PC



**Art. CNP50**



**Art. 007**



**Art. 016**



**Art. SL4**



**Art. 019.1**



**Art. 168PC**



**Art. 018**



**Art. 043P**



## FITNESS BODY-BUILDING

Art. S01108

Art. S01106

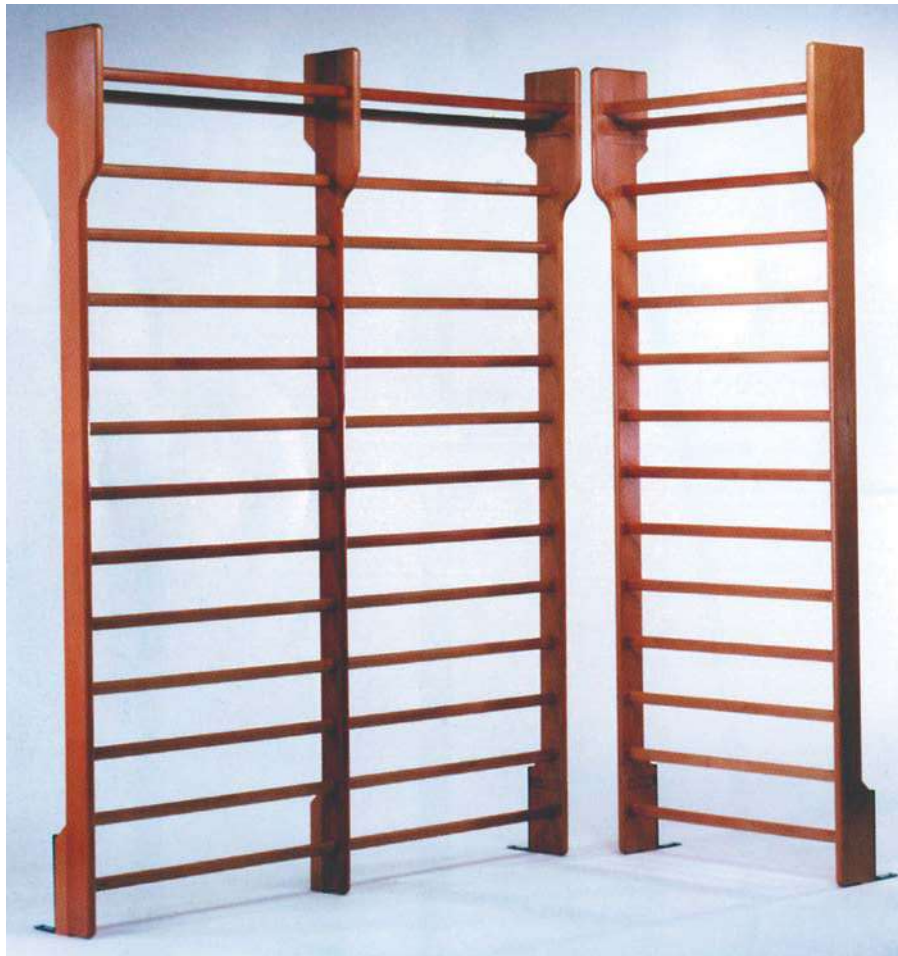

**Art. S01106**  
**Spalliera Svedese**  
**a 1 campata**  
**dim. 90x250 cm.**  
**in faggio evaporato**  
Swedish Wall Bar 1 span

● pg.13

**Art. S01108**  
**Spalliera Svedese**  
**a 2 campate**  
**dim. 180x250 cm.**  
**in faggio evaporato**  
Swedish Wall Bar 2 spans



**Art. S00908**  
**Panca per addominali imbottita**  
**agganciabile a spalliera**  
Abdominal bench to be fixed to  
Swedish Wall Bar



**Art. UNG05 / UNG1 / UNG2 / UNG3 / UNG4 / UNG5**  
**Coppia Manubri in ghisa rivestiti**  
**Kg. 0,5-1-2-3-4-5 cadauno**  
Pair of Dumb Bells from 0,5 to 5 Kg. each one

● pg.12



**Art. F301**  
**Porta manubri in ferro**  
Dumb Bell Rack



**Art. 17222**  
**Cintura Body Building h. cm. 10 - misure da S a XL**  
Body Building Leather Belt h. 10 cm.  
sizes from S to XL





**Art. AS196**  
**Coppia fermadischi a vite**  
Pair of plate holders with thread

pg.11 pg.12

**Art. US176**  
**Coppia fermadischi a T**  
Pair of T-shaped plate holders



**\*Fermadischi a vite inclusi**  
Plate holders with thread included

**\*Art. US304/US305**  
**Bilanciere** Weight bar  
cm. 150 / cm. 180

**\*Art. US301 Manubrio a dischi inseribili cm. 35**  
Hand bar length 35 cm.



**\*Art. US303**  
**Bilanciere sagomato**  
Bar cm. 120



**Art. UN640**  
**Dischi in ghisa foro mm.26**  
Kg. 0,5 - 1 - 2 - 5 - 10  
15 - 20 cadauno  
Cast Iron Weight Plates  
hole 26 mm.



**Art. DGG**  
**Dischi in ghisa foro mm.26 rivestiti in gomma**  
Kg. 0,5 - 1 - 2 - 5 - 10 - 15 - 20 cadauno  
Cast Iron Weight Plates hole 26 mm. covered with rubber



**Art. US287**  
**Coppia fermadischi a molla**  
Pair of spring plate holders

**Art. F302**  
**Porta dischi in ferro**  
Weight Plates Rack



**Art. 17203**  
**Paio guanti Lycra**  
misure da XS a XL  
vari colori  
Gym Gloves Lycra

pg.12



**Art. 30907**  
**Paio guanti Premium Pro**  
misure da S a XL  
vari colori  
Gym Gloves Premium Pro



**Art. 13382 / 13383 / 13384 / 30937**  
**Paio Cavigliere Kg. 0,5 - 1 - 1,5 - 2 cadauna**  
Pair of Ankle Weights 0,5 - 1 - 1,5 - 2 Kg. each one



**Art. AHF-093**  
**Paio Cavigliere Kg. 2,5 cadauna con pesi estraibili**  
Pair of Ankle Weights 2,5 Kg. each removable weights







**Art. AHF-026**  
**Coppia maniglie per flessioni**  
Push-up handles

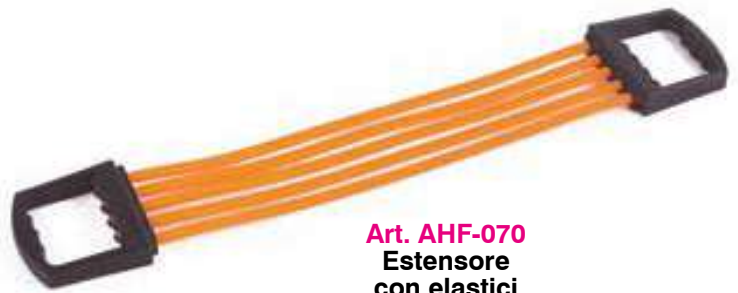

**Art. AHF-070**  
**Estensore con elastici**  
Chest-Expander



**Art. AHF-161**  
**Coppia Parallettes h. cm. 75**  
Pair of Parallettes 75 cm. height

pg.12



**Art. AHF-074**  
**Coppia sostegni ruotabili per flessioni**  
Turnable Push-up handles



**Art. AHF-021**  
**Coppia Tenaglie stringimano con impugnatura soft touch**  
Pincers for hand strengthening



**Art. AHF-047**  
**Ruota doppia per addominali**  
Double Wheel for abdominal muscles



**Art. AHF-157**  
**Coppia manubri con ruote per addominali**  
Pair of dumb bells with wheels for abdominal muscles



**Art. AHF-063**  
**Contapassi (ad esaurimento)**  
Step Counter (until available)

pg.13



**Art. AHF-064**  
**Contapassi multifunzione**  
Multi-function Step Counter





**Art. BTM-R**  
**Barra per trazioni**  
**con fissaggio a parete**  
**o soffitto**  
Exercise Bar

pg.12



**Art. BTE**  
**Barra Entroporta**  
Door Bar



**Art. DEAPWR**  
**Ministepper a pistoni idraulici con elastici per il**  
**potenziamento di braccia, dorso e addome**  
**Computer a 2 funzioni: tempo, calorie**  
**Peso massimo utilizzatore 100 kg.**  
Ministepper with hydraulic rams and elastic bands for  
strengthening arms, back and abdomen

**Art. OCST**  
**Gradino step a 2 altezze (10-15 cm.)**  
**con antiscivolo dim. cm. 68x30**  
Step 2 heights  
(10-15 cm.) with anti-skid dim. 68x30 cm.



pg.13

**Art. WBX-70**  
**Power Tower**  
**Attrezzo multifunzione ideato per l'allenamento intensivo**  
**di tutto il corpo senza l'utilizzo dei pesi**  
**Tubolare a sezione quadrata da 5 cm.**  
**Peso massimo utilizzatore 120 Kg.**  
Multi purpose tool for intensive  
body training without weights



**Art. AHF-003**  
**Gradino step regolabile a 3 altezze**  
**(cm. 15-20-25)**  
**superficie antiscivolo dim. cm. 89x39**  
Step adjustable at 3 different heights  
(maximum height 25 cm.)  
with anti-skid surface dim. 89x39 cm.

pg.12



**Art. E680**  
**Bracciale porta oggetti**  
**in neoprene cm.14,5x8x2**  
Neoprene arm wallet

pg.13



**Art. AHF-165**  
**Fascia da braccio**  
**porta smartphone**  
Arm smartphone holder





**Art. WBK-400**  
Panca multifunzione  
telaio in acciaio,  
schienale regolabile  
portata massima kg. 120  
Weight lifting Bench



**Art. WBK-500**  
Panca pesi con supporti  
bilanciere, telaio in acciaio,  
schienale regolabile  
peso max utilizzatore kg. 100  
Weight lifting Bench  
with bar holders

**ATTENZIONE:** questi prodotti sono concepiti esclusivamente per uso home fitness, perciò la garanzia non copre il loro utilizzo presso palestre o centri sportivi



**Art. WBX-85**  
Panca piana/90° Power Bench  
rinforzata (abbinabile con Power Rack)  
Power Bench

pg.13



**Art. GYM1000**  
Stazione Multifunzione  
dotata di torre per dorsali, pressa per  
pettorali, attrezzo per le gambe, vogatore,  
cuscino per bicipiti - carico massimo 60 Kg.  
15 esercizi praticabili  
Peso massimo utilizzatore 120 Kg.  
Multi purpose machine



**Art. WBX-50**  
Power Rack  
Supporti per bilanciere  
Altezza e larghezza  
regolabili  
Dotato di 2 rimessaggi  
per dischi  
Peso massimo  
caricabile 200 Kg.  
Supports for weight bar





**Art. 729761**  
Panca a inversione chiudibile  
Schienale rigido imbottito  
Regolabile secondo l'altezza  
dell'utilizzatore: minima cm. 147,  
massima cm. 198  
Peso max utilizzatore 100 Kg.  
Inversion Bench

**ATTENZIONE:** questi prodotti sono concepiti esclusivamente per uso home fitness, perciò la garanzia non copre il loro utilizzo presso palestre o centri sportivi

**Art. WBK-100**  
Panca per addominali  
chiudibile  
portata kg. 100  
Bench for abdominal  
muscle training



pg.13

**Art. AB-CNH**  
AB Crunch Master  
richiudibile  
AB Crunch Master  
foldable



**Art. WBK-600**  
Panca multifunzione  
a cavi elastici  
richiudibile  
Foldable multi-function  
bench



**Art. GWM13**  
Pedaliera manuale  
utilizzabile da seduti per gli arti inferiori  
e appoggiata sul tavolo per gli arti superiori  
Peso 5 Kg. - con computer  
Intensità sforzo regolabile  
Cycling device for arm and leg exercises

pg.12



**Art. GWE13**  
Pedaliera elettrica  
per la ginnastica passiva  
degli arti inferiori e superiori  
Velocità regolabile con telecomando  
Peso 6 Kg. - con computer  
Cycling electric device for arm and leg exercises





**Art. BFK-300**

Bicicletta da camera con freno magnetico  
Regolazione dell'intensità manuale a 8 livelli  
Volano da 4 Kg. - Computer a 6 funzioni: tempo, velocità, distanza, calorie, scan, pulsazioni con sensori Hand Pulse  
Peso massimo utilizzatore 100 Kg. - Peso dell'attrezzo 20 Kg.  
Cyclette Magnetic with 6 function computer

**Art. BRX-60**

Bicicletta da camera con freno magnetico  
Regolazione dell'intensità manuale a 8 livelli  
Volano da 7 Kg. - Computer a 6 funzioni: tempo, velocità, distanza, calorie, odometro, pulsazioni con sensori Hand Pulse  
Peso massimo utilizzatore 110 Kg.  
Peso dell'attrezzo 24 Kg.  
Cyclette Magnetic with 6 function computer



pg.13

**ATTENZIONE:** questi prodotti sono concepiti esclusivamente per uso home fitness, perciò la garanzia non copre il loro utilizzo presso palestre o centri sportivi

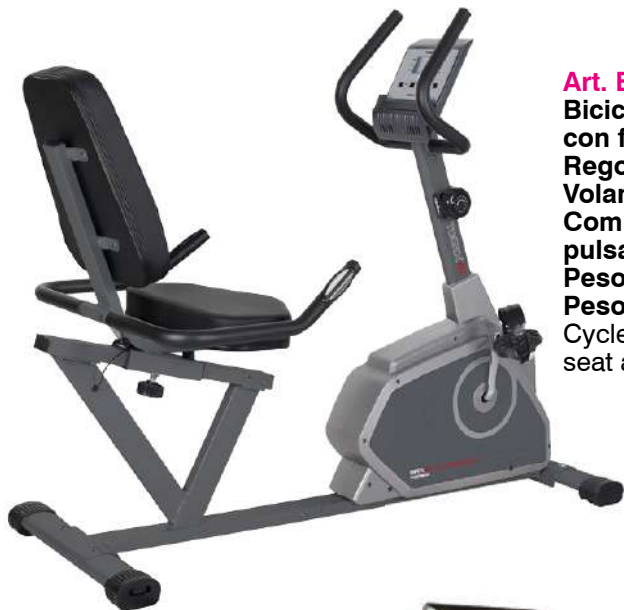

**Art. BRX-RC**

Bicicletta da camera BRX-R 65 COMFORT con freno magnetico e sedile con schienale  
Regolazione dell'intensità manuale a 8 livelli  
Volano da 7 Kg.  
Computer a 7 funzioni: tempo, velocità, distanza, calorie, pulsazioni con sensori Hand Pulse, odometro, scan  
Peso massimo utilizzatore 110 Kg.  
Peso dell'attrezzo 29,5 Kg.  
Cyclette Magnetic with 7 function computer, seat adjusting system

**Art. SRX60**

Spinning Bike  
SRX60 EVO  
con volano da 20 Kg.  
Trasmissione a cinghia con pignone fisso  
Sistema di frenaggio a tampone con feltri  
Computer con LCD (velocità, tempo, distanza, calorie, odometro, pulsazioni)  
Sella regolabile in orizzontale ed in altezza  
Manubrio regolabile in altezza con appoggio per l'avambraccio  
Portaborraccia  
Peso massimo utilizzatore 125 Kg.  
Peso dell'attrezzo 41 Kg.  
Cyclette Magnetic with seat and handle-bar adjusting systems



**Art. 18220**  
Coprisella spinning  
Seat cover for spinning bike





**Senza motore.  
Adatto per camminare,  
non per correre**  
With no engine. Suitable for  
walking, not to run

pg.13

**Art. TFK-MAG**

**TAPIS ROULANT MAGNETICO TFK-SLIM-MAG**  
piano di corsa cm.38x102

sistema di frenaggio magnetico su 8 livelli  
doppio volano Kg.6 - peso massimo  
utilizzatore Kg.100 - display LCD indicante velocità,  
frequenza cardiaca, distanza, tempo,  
consumo calorico, scan, rilevazione cardio Hand Pulse  
Tapis roulant magnetic with no engine,  
with multi function computer



**Art. TFK-200**

**TAPIS ROULANT TFK-200**

motore 1,75/2,75 HP DC - velocità 0,8-14 Km/h  
inclinazione manuale - piano di corsa cm. 42x123  
peso massimo utilizzatore 100 Kg.  
1 programma libero, 16 preimpostati, display LCD  
indicante velocità, frequenza cardiaca, distanza,  
tempo, consumo calorico, programma in esecuzione  
Tapis roulant with 1,75/2,75 hp engine and  
multi program computer

pg.13

**ATTENZIONE:** questi prodotti sono  
concepiti esclusivamente per uso  
home fitness, perciò la garanzia  
non copre il loro utilizzo presso  
palestre o centri sportivi



**Art. TFK-455**

**TAPIS ROULANT TFK-455 SLIM - salvaspazio**  
motore 2,00/3,00 HP DC - velocità 0,8-16 Km/h  
inclinazione elettrica - piano di corsa cm.42,5x127  
peso massimo utilizzatore 110 Kg.

1 programma libero, 12 preimpostati, display LCD  
indicante velocità, inclinazione, frequenza cardiaca  
tramite Hand Pulse, distanza, tempo,  
consumo calorico, programma in esecuzione  
Tapis roulant with 2/3 hp engine and multi program computer

**Art. TRXRC**  
**Vogatore Rower Compact - display LCD indicante**  
numero vogate, calorie, tempo, scan  
regolazione sforzo su 12 livelli  
peso max utilizzatore 110 Kg.  
Rower machine with computer





## CASACCHE - Mesh Shirts



**Art. 088-A**

### Casacca traforata fluo taglia adulto

Fluo pierced training bib adult size - colors as in the picture



**Art. 088-B**

### Casacca traforata fluo per bambini fino a 9 anni

Fluo pierced training bib small size  
(for children up to 9 years)  
colors as in the picture



pg.15

**Art. 088-D**

### Casacca traforata double-face fluo taglia adulto colori rosso/blu - giallo/arancio

Fluo pierced training bib double-face adult size  
colors red/blue - yellow/orange



**Art. GIL01**

### Gilet steward

Colori giallo - arancio  
Colors yellow - orange



## PANTALONCINI - CALZE - GUANTI - T-SHIRT - GIACCHE PIOGGIA Shorts - Socks - Gloves - T-shirt - Rain jackets

**\*\* QUANTITÀ PER TAGLIA E COLORE MULTIPLA DI 5 PEZZI \*\***  
Quantity by size and color multiple of 5 pieces



**Art. MF01**  
Pantaloncino da allenamento  
100% poliestere  
taglie dalla 3XS alla XXL  
Colori: royal, bianco, bordeaux,  
verde, navy, rosso, nero  
(quantità per taglia e colore  
multipla di 5 pz.)  
Shorts in polyester  
size from 3XS to XXL  
Colors: white, red, royal,  
blue, black, brown, green  
(quantity by size and color  
multiple of 5 pieces)

pg.15



**Art. IS005**  
Paio calze calcio con piede  
Taglie  
Bimbo: 29-34  
Ragazzo: 35-40  
Uomo: 41-46  
Colori: royal, giallo limone, bianco,  
bordeaux, navy, rosso, nero,  
Pair of soccer socks sizes: Kid, JR, SR  
Colors: white, red, royal, blue, black, brown,  
lemon yellow



**Art. E6017**  
Guanti in acrilico  
colore nero  
misura junior e senior  
Black acrylic Gloves  
size junior and senior



pg.16

**Art. E6000**  
Scaldacollo in pile  
taglia unica regolabile  
colore navy o nero  
Neck warmer in pile  
one size fits all

**Art. E6013**  
Berretto in acrilico  
nero, navy  
taglia senior  
Winter Cap  
size senior



pg.15



**Art. 07761A**  
Giacca antipioggia con marsupio  
taglie dalla XXXS alla XXL  
colore navy  
Rain Jacket - sizes XXXS to XXL  
color blue



pg.15

pg.16

**Art. TSG10/TSG11**  
T-SHIRT colori: bianco, nero, rosso,  
verde, giallo, arancio, blu, royal  
misure: bambino dalla S alla XL adulto dalla S alla XXL,  
neutra oppure personalizzata con logo ad un colore  
(ordine minimo per la personalizzazione 50 pezzi)  
T-Shirt various colors and size, also with your logo on request  
(minimum order for customization 50 pieces)



**Art. SB099**

**TUBOLARE BARRET in microfibra 108 dinari**  
Prodotto tecnico brevettato come modello d'uso CEE - Made in Italy  
Lascia traspirare la pelle e ripara dal freddo e dal vento  
utilissimo in molteplici situazioni:  
durante e dopo gli allenamenti, durante gli incontri,  
per sostenere la tua squadra, nel tempo libero, in moto etc.



**Prodotto bi-elastico senza cuciture**  
bi-elastic seamless

pg.16

Barret TUBOLAR HAT in microfiber - made in Italy patented  
BTH lets your skin breath while protecting you from cold and wind  
you can wear it during or after training, during the game, in your spare time,  
to support your team, when riding your bike etc.



utilizzabile come scaldacollo, foulard, bandana, fascia, passamontagna etc.



it can change shape from neck warmer to head band to foulard to bandana

**PRODOTTO TECNICO**  
**TECHNICAL PRODUCT**



**A differenza del comune prodotto in pile, la microfibra del Tubolare Barret impedisce il surriscaldamento e l'eccessiva sudorazione della pelle, grazie alla sua speciale traspirazione e leggerezza**

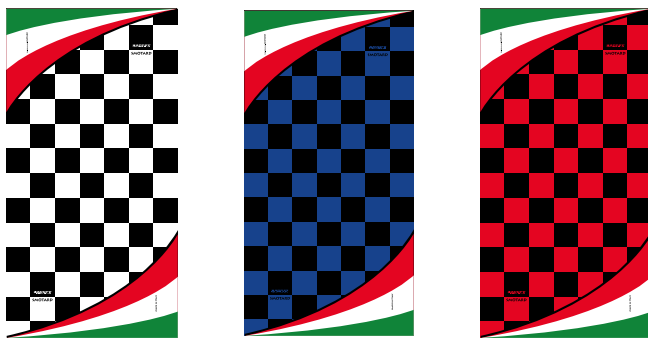

**Colori disponibili:**  
bianco/nero, nero/azzurro, rosso/nero, bianco/celeste, bianco/rosso, giallo/rosso, azzurro nazionale italiana (prodotto personalizzabile su richiesta per ordine minimo di 100 pezzi, con spese per elaborazione grafica da definire)



Colors available as in the pictures  
Barret tubular HAT can be personalized with your logo and colors with a minimum order of 100 pieces (graphic work not included in the price)

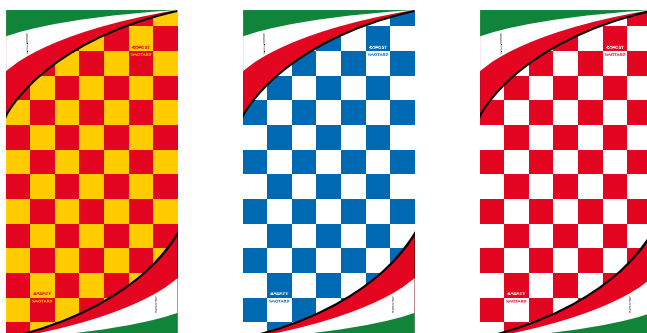



## TACCHETTI ED ACCESSORI PER SCARPE - Studs and Shoe accessories



**Art. 265bis / 268bis / 270bis**  
**Tacchetto alluminio conico**  
**mm. 14-17-19**  
**conf. 100 pz. per misura**  
Conical aluminium Stud  
14-17-19 mm.  
100 piece pack

pg.13

pg.14



**Art. BACS**  
**Blister 12 tacchetti in alluminio**  
**conici senza rondelle**  
**(8 x mm. 14 + 4 x mm. 17)**  
12 piece pack conical aluminium  
studs without washers



**Art. BACSC**  
**Blister 12 tacchetti in alluminio**  
**conici con rondelle**  
**(8 x mm. 14 + 4 x mm. 17)**  
12 piece pack conical aluminium  
studs with washers



**Art. 262/263/264/265/266/267/268/269/270**  
**Tacchetto alluminio conico tornito**  
**mm. 11-12-13-14-15-16-17-18-19**  
**conf. 100 pz. per misura**  
Milled conical aluminium Stud  
100 piece pack



**Art. PR11 / PR14 / PR17**  
**Tacchetto alluminio conico tornito**  
**punta rinforzata mm. 11-14-17**  
**conf. 100 pz. per misura**  
Conical aluminium Stud  
reinforced tip 11-14-17 mm.  
100 piece pack

pg.14



**Art. A11 / A13 / A15 / A17**  
**Tacchetto alluminio conico tornito**  
**Argentinos superleggero Serie A**  
**mm. 11-13-15-17**  
Milled conical aluminium Stud  
ultra-light Serie A  
11-13-15-17 mm.



**Art. AL09F / AL11F / AL13F / AL15F**  
**Tacchetto alluminio conico tornito Argentinos superleggero Serie A**  
**con filettatura maggiorata (Adidas) mm. 9-11-13-15**  
Milled conical aluminium Stud ultra-light Serie A  
with increased thread (Adidas) 9-11-13-15 mm.





**Art. 292 / 293 / 294 / 294bis**  
**Tacchetto in nylon conico punta rinforzata in alluminio**  
 mm. 11, 13, 15, 17 - conf. 100 pz. per misura  
 Conical Nylon stud with reinforced tip - 100 piece pack



**Art. BNPR1 / BNPR2**  
**Blister 12 tacchetti in nylon punta rinforzata**  
 mm. 11-13-15 / mm. 13-15-17  
 12 piece pack nylon studs with reinforced tip  
 mm. 11-13-15 / mm. 13-15-17

(pg.14)



**Art. M204 / M205**  
**Tacchetto in nylon monocolore**  
 mm. 13 / 16  
 conf. 100 pz. per misura  
 Nylon Stud  
 mm. 13 / 16 - 100 piece pack



**Art. M203**  
**Blister 12 tacchetti in nylon monocolore**  
 8 x mm. 13 + 4 x mm. 16  
**(nero, rosso, bianco)**  
 12 piece pack nylon studs single color (black, red, white)



**Art. 35M12**  
**Tacchetto gomma base stretta mm. 12 conf. 100 pz.**  
 Narrow Base Rubber Stud mm. 12 - 100 piece pack

**Art. 35M14**  
**Tacchetto gomma base stretta mm. 14 conf. 100 pz.**  
 Narrow Base Rubber Stud mm. 14 - 100 piece pack



**Art. 072.11.13**  
**Confezione blister 12 Tacchetti gomma base larga per terreni gelati**  
**(8 x mm. 11+ 4 x mm. 13)**  
 Wide Base Rubber Stud - for icy ground  
 12 piece pack



**Art. 302 Base filettata in alluminio - conf. 50 pz. per misura**  
 Threaded aluminium bases mm. 7, 8, 10, 12 - 50 piece pack

**Art. 302G Base filettata in alluminio - conf. 50 pz. per misura**  
 Threaded aluminium bases mm. 13, 14, 17 - 50 piece pack

**Art. 314 Rondella in alluminio - conf. 100 pz.**  
 Aluminium washer - 100 piece pack



**Art. CHAZ**  
**Chiave in acciaio zincocromata**  
 Stud Key





**Art. 317 / 318**  
**Paio tendiscarpe a molla,**  
**misura 40-42 / 43-45**  
 Shoe stretchers with spring,  
 size 40-42 / 43-45

● pg.14

● pg.15

**Art. BLS4**  
**Lastrina antitrauma ritagliabile in gel forata**  
**spessore mm.4 dimensioni cm.14x28**  
**da utilizzare a contatto con la pelle del piede**  
**dentro la scarpa in caso di ferite, vesciche o**  
**contusioni: attutisce il dolore derivante dalla**  
**corsa e dall'impatto con la palla**

Anti-shock pierced gel thickness 4 mm. size  
 cm.14x28 you can cut it and place it inside your  
 shoe against the skin to prevent pain from running  
 and kicking in case of small foot injuries



**Art. 326 / 326FL / 327 / 327FL / 328 / 328FL**

**Paio lacci per scarpe cm.120-150-180**  
**colori nero, bianco, giallo fluo, verde fluo, arancio fluo**  
 Pair of shoe laces 120-150-180 cm. long  
 colors: black, white, fluo yellow, fluo green, fluo orange



**Art. SOL.SP**  
**Paio solette in gel**  
**profumate ritagliabili**  
 Gel Insoles



**Art. ALZ.SP**  
**Paio Alzatacco in gel**  
**taglia 1 donna**  
**taglia 2 uomo**  
 Gel under heel softeners  
 woman and man sizes



**Art. 21654**  
**Paio solette**  
**Spugna Sport**  
 Sport Insoles

● pg.15



**Art. E6694**  
**Paio Alzatacco in silicone**  
**misura S (33/36) - M (37/40)**  
**L (40/44) - XL (44/48)**  
 Silicone under heel softeners  
 various sizes





Art. 238.1

Art. 238



Art. S489

Spazzola in setola naturale  
Shoe Brush

pg.14



Art. SL.S

Spugna lucidascarpe  
(ad esaurimento)  
Shoe polisher sponge  
(until available)

Art. 238.1

**Grasso Aquila Kg.1**  
Aquila Grease for shoes  
Kg. 1

pg.15

Art. 238

**Grasso Aquila ml. 100**  
Aquila Grease for shoes  
ml. 100

Art. 34071A

**Spray impermeabilizzante**  
Spray waterproofing



pg.14

Art. D122X

**Spray Dilato ml. 200 ammorbidente**  
Spray to soften leather  
soccer shoes



pg.15

Art. TE.540.01

**Zerbino puliscscarpe in plastica con ventose**  
dimensioni cm.35x27  
Shoe cleaning device  
in plastic with suckers  
dimension 35x27 cm.



Art. FA270

**Macchina lavascarpe con 4 spazzole sostituibili**  
getti incrociati regolabili ad alta pressione  
completo di poggiamani e 4 fori di fissaggio a terra  
in dotazione fascetta in acciaio per collegamento tubo  
mm 15x21 (non incluso) alla rete idrica.  
Shoe washing device - high pressure crossed water jets  
iron frame with handles - replaceable brushes  
easy fixing to the floor with 4 holes





## PARASTINCHI - Shinguards



**Art. PSCV**  
Paio parastinchi  
senza cavigliera  
misura adulto e bambino  
Pair of shinguards  
without ankle protection  
junior and senior size

**Art. IS30HS**

Paio parastinchi  
senza cavigliera  
misura S-M-L  
Pair of shinguards  
without ankle protection  
size S-M-L



pg.15

**INNOVATIVO PARASTINCO BARRET REALIZZATO CON SPECIALI LISTELLI ANATOMICI  
LEGGERRISSIMO MA CON ALTA RESISTENZA ALL'IMPATTO  
BARRET SPECIAL SHINGUARDS anatomic, very light and highly resistant to impact**



**Art. BP90**

Paio parastinchi Barret senza cavigliera misura unica  
Pair of Barret shinguards without ankle protection  
one size fits all

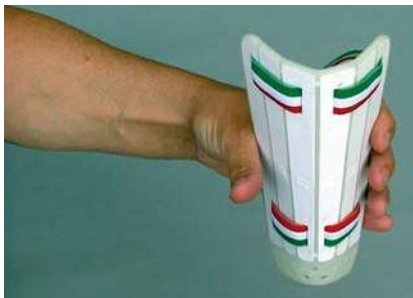

**BREVETTATO  
PATENTED**



**Art. PBC**  
Paio parastinchi  
con cavigliera  
misura adulto  
Pair of shinguards  
with ankle protection  
senior size





## FASCE CAPITANO - GUANTI PORTIERE - Captain's Armbands - GK Gloves

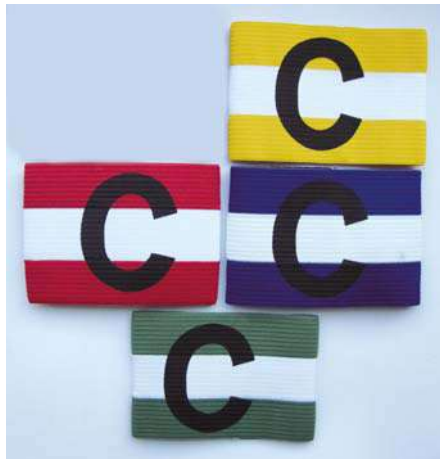

**Art. 150**  
Fascia capitano elastica  
misura adulto  
Elastic Captain's armband  
size adult

**Art. 150.B**  
Fascia capitano elastica  
misura bambino  
Elastic Captain's armband  
size children

pg.16



**Art. 150F** Fascia capitano elastica  
mis. adulto colore giallo o arancio fluo  
Elastic Captain's armband adult size  
colors: fluorescent yellow and orange



**Art. 150V.9**  
Fascia capitano con velcro, taglia adulto  
colori: bianco, rosso, giallo fluo, verde,  
blu e arancio fluo - h. cm. 9  
Captain's armband adjustable length - 9 cm. height  
size adult - colors: white, red, fluo yellow,  
blue, green, fluo orange



**Art. 150V / 150V.B**  
Fascia capitano con velcro, taglia adulto o bambino  
Modello Champions colori bianco, rosso, giallo, verde,  
blu, fucsia, arancio - h. cm. 6,5  
Captain's armband adjustable length - 6,5 cm. height  
size adult or children  
colors: white, red, yellow, blue, green,  
fuchsia, orange



**Art. 150V.9N**  
Fascia capitano neutra con velcro, taglia adulto  
h. cm. 9 - colori: giallo fluo, arancio,  
bianco, rosso, verde, blu  
Captain's armband with no "C" printed  
adjustable length 9 cm. height size adult  
colors: fluo yellow, orange, white, red, green,  
blue



**Art. 1000PG**  
Paio Guanti portiere misure da 6 a 11  
Pair of Goalkeeper Gloves  
Size from 6 to 11

pg.15

**Art. F30BG**  
Paio Guanti  
portiere junior  
misure da 4 a 7  
Pair of  
Goalkeeper Gloves  
Size from 4 to 7



I colori dei guanti raffigurati nelle immagini possono variare



## NUMERAZIONI TERMOSALDABILI Numbers for Uniforms

Colori disponibili: bianco, giallo, rosso, verde, royal, blu, granata, nero, oro, argento  
Available colors: white, yellow, red, green, royal, blue, brown, black, gold, silver

Art. PN23



Art. PN18



Art. PN10



● pg.16

Art. PG23

**Numeri termosaldabili Serie Omega h.23 cm. in confezione da 1 a 22**  
Numbers for sport uniforms Omega series 23 cm. height package from number 1 to number 22

Art. PG18

**Numeri termosaldabili Serie Omega h.18 cm. in confezione da 1 a 22**  
Numbers for sport uniforms Omega series 18 cm. height package from number 1 to number 22

Art. PG10

**Numeri termosaldabili Serie Omega h.10 cm. in confezione da 1 a 22**  
Numbers for sport uniforms Omega series 10 cm. height package from number 1 to number 22

Art. PN23

**Numeri termosaldabili Serie Omega h.23 cm. numeri singoli (da 0 a 9)**  
Single numbers for sport uniforms Omega series 23 cm. height (from 0 to 9)

Art. PN18

**Numeri termosaldabili Serie Omega h.18 cm. numeri singoli (da 0 a 9)**  
Single numbers for sport uniforms Omega series 18 cm. height (from 0 to 9)

Art. PN10

**Numeri termosaldabili Serie Omega h.10 cm. numeri singoli (da 0 a 9)**  
Single numbers for sport uniforms Omega series 10 cm. height (from 0 to 9)



**TEMPERATURA MASSIMA 135 °C**  
**TEMPO MASSIMO DI APPLICAZIONE**  
**6 SECONDI**  
**MAXIMUM TEMPERATURE 135 °C**  
**MAXIMUM 6 SECOND PRINT**

Art. PG4

**Numeri termosaldabili Serie Omega h.4 cm. in confezione blister numeri da 1 a 100 colore bianco, blu o nero**  
**La numerazione progressiva (di 100 in 100) arriva fino a 500**  
Numbers for sport uniforms Omega series 4 cm. height package from number 1 to number 100 black, blue or white color



## MATERASSINI - Mats

**Art. 044**  
**Materassino pieghevole**  
**alta densità**  
**cm. 180x50x0,7**  
Folding foam Mat  
high density  
180x50x0,7 cm.

**Art. 044-A**  
**Materassino pieghevole**  
**alta densità**  
**cm. 180x60x0,7**  
Folding foam Mat  
high density  
180x60x0,7 cm.

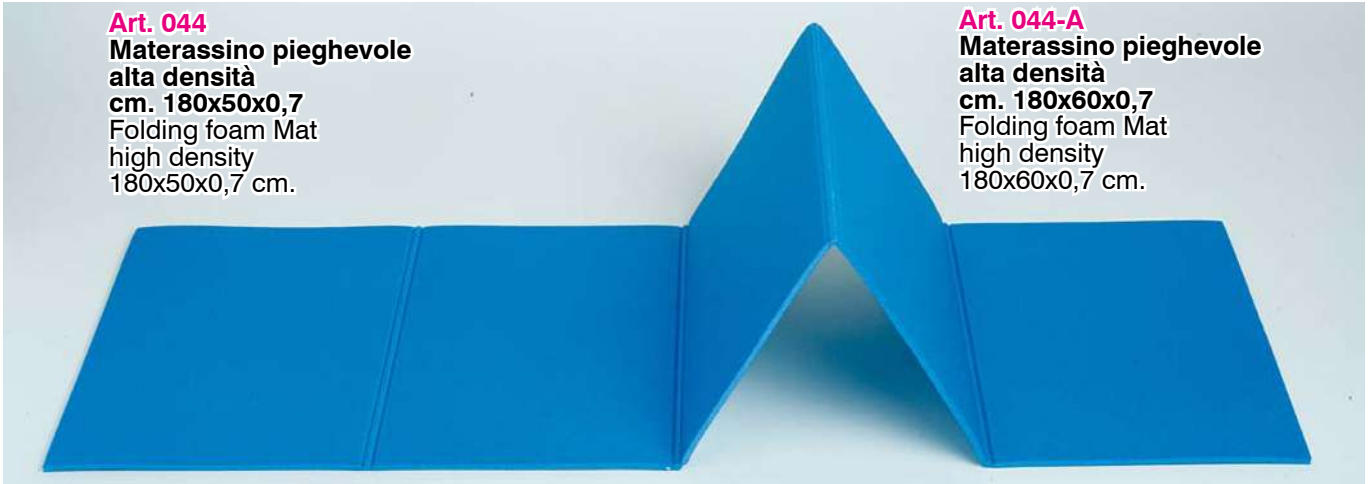

pg.16

**Art. 044-R**  
**Materassino arrotolabile**  
**alta densità**  
**cm. 180x50x0,6**  
Rolled foam Mat  
high density 180x50x0,6 cm.

**Art. AS803**  
**Materassino Exercise Mat**  
**imbottito e serigrafato cm.180x60x2,5**  
PVC Mat 180x60x2,5 cm.



**Art. 30924**  
**Materassino Yoga arrotolabile**  
**cm. 172x60x0,4**  
Rolled Yoga Mat 172x60x0,4 cm.



## LAVAGNE TATTICHE PER CALCIO E CALCETTO - Tactical Boards for Football and Futsal

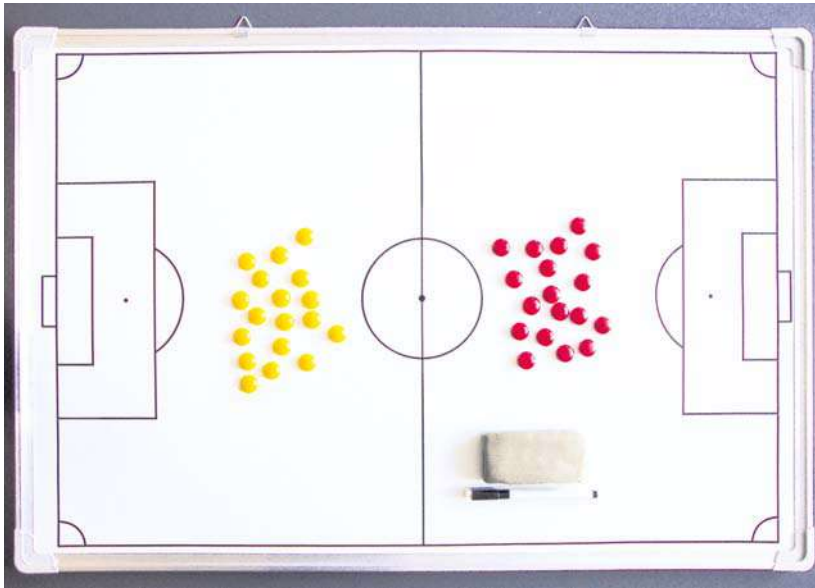

**Art. 087**  
**Lavagna magnetica cm. 60x90 cancellabile con cornice metallica**  
Tactical board 60x90 cm. magnetic and erasable with metal frame

**Art. 087.BO**  
**Borsa per lavagna magnetica Art. 087 cm. 60x90**  
Bag for tactical board Art. 087 60x90 cm.



**Art. PM60**  
**Serie pedine magnetiche di ricambio per lavagna Art. 087**  
Spare magnetic pieces for tactical board Art. 087

pg.17 pg.18



**Art. M087TP**  
**Treppiede di sostegno in acciaio verniciato per lavagna Art. 087 (lavagna esclusa)**  
Painted steel tripod for board Art. 087 (board not included)



**Art. 090**  
**Lavagna su treppiede con 100 fogli cm.70x100 (non cancellabili)**  
Board on tripod with 100 sheets 70x100 cm. (not erasable)

**Art. 090RIC**  
**Ricambio 100 fogli cm.70x100 per lavagna Art. 090 (treppiede escluso)**  
100 spare sheets for board Art. 090 (tripod not included)

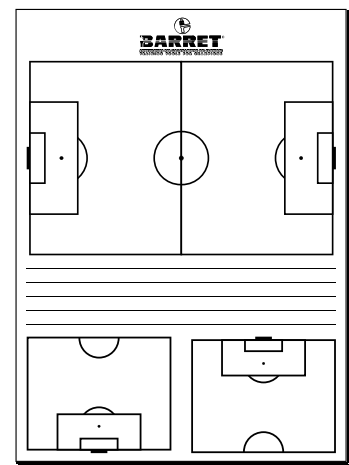

**Art. BL50F**  
**Blocco con 50 fogli formato A4 (non cancellabili)**  
Block with 50 A4 sheets (not erasable)

pg.18



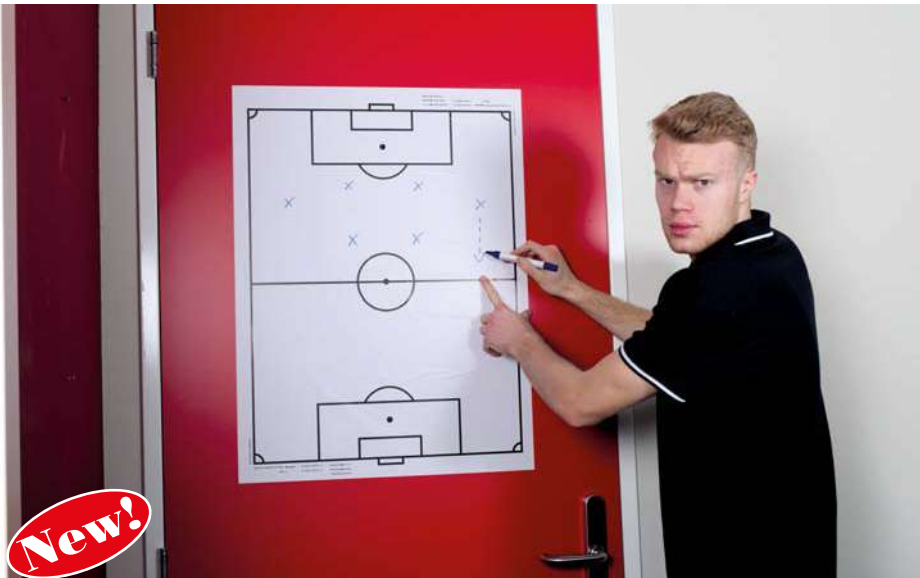

**Art. 05030425**

**Set 25 fogli adesivi cm.60x80 applicabili a porte e pareti, rimuovibili e cancellabili (ideale per partite in trasferta)**

Set of 25 adhesive sheets 60x80 cm. on a roll, easily separable. Due to the electrostatic charge, it can be hung on any door or wall and removed several times without leaving any trace. Ideal for away games. Either permanent or non permanent markers work for writing

pg.17

**Lato A**  
Side A

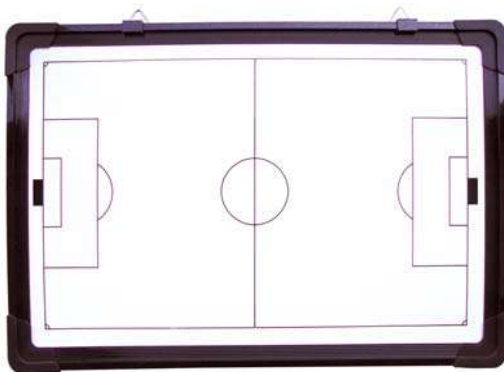

**Lato B**  
Side B



**Art. 089**

**Lavagna magnetica bifacciale cancellabile con borsa cm. 45x30**  
2 face Tactical Board magnetic and erasable 45x30 cm. with bag

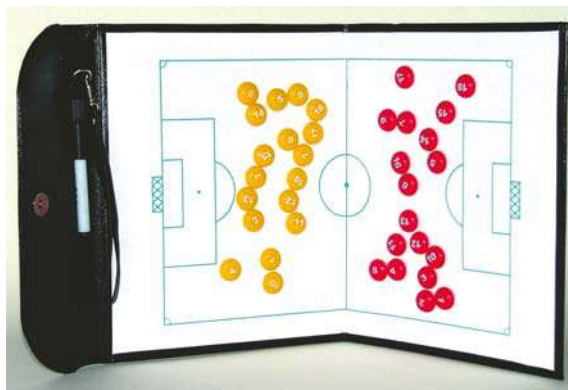

**Art. 089-P**

**Lavagna magnetica cancellabile pieghevole cm. 46x25**

Foldable Tactical Board magnetic and erasable 46x25 cm.

**Lato A**  
Side A

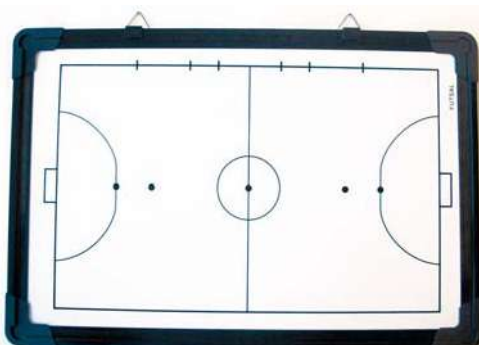

**Lato B**  
Side B



**Art. 089CM**

**Lavagna Tattica Calcio bifacciale magnetica e cancellabile cm. 45x30**  
2 face Futsal Tactical Board magnetic and erasable 45x30 cm.

pg.18



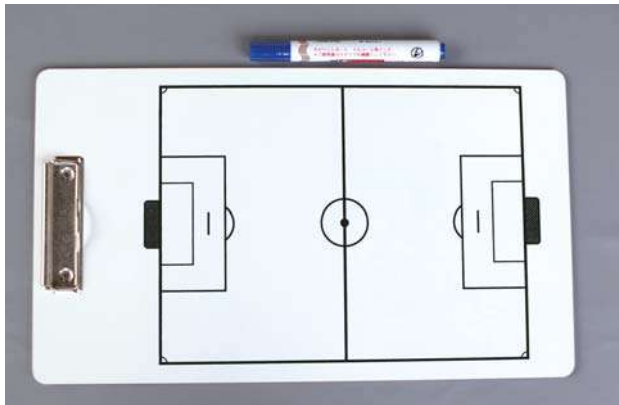

**Art. 089-A**

**Lavagna bifacciale cancellabile cm. 40x23**  
2 face Tactical Board erasable, 40x23 cm.



**Art. CSRK**

**Lavagna Tattica magnetica cancellabile con block-notes cm. 40x23**  
Magnetic Tactical Board 40x23 cm. erasable

● pg.17

● pg.18

**Art. 089-C**

**Lavagna Tattica Calcio bifacciale cancellabile cm. 40x23**  
2 face Futsal Tactical Board 40x23 cm. erasable

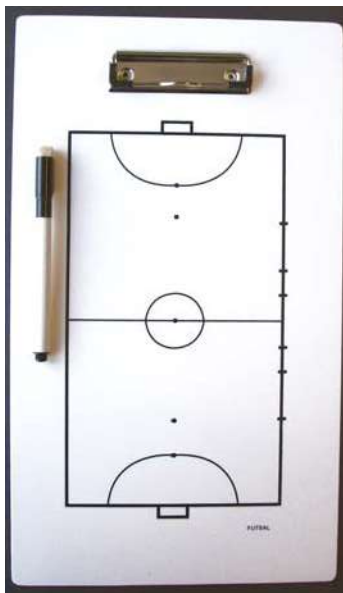

**Art. PM**

**Serie pedine magnetiche di ricambio per lavagne di dimensioni ridotte**  
Spare magnetic pieces for small tactical boards

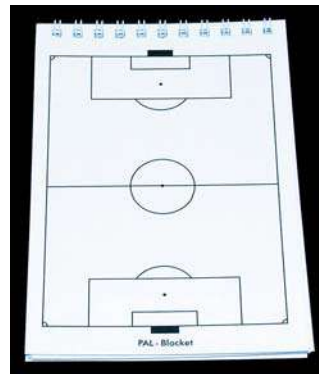

**Art. PAL-B**

**Pal Block - blocco tascabile con 25 pagine copertina cancellabile**  
Pocket block-notes 25 pages with erasable cover



**Art. 18330**

**Lavagna magnetica cancellabile pieghevole Multisport (Calcio, Basket, Volley, Rugby, Badminton, Tennis, Floorball, Pallamano, Hockey su ghiaccio)**  
dimensioni cm. 32x22  
Multisport Foldable Tactical Board magnetic and erasable 32x22 cm.



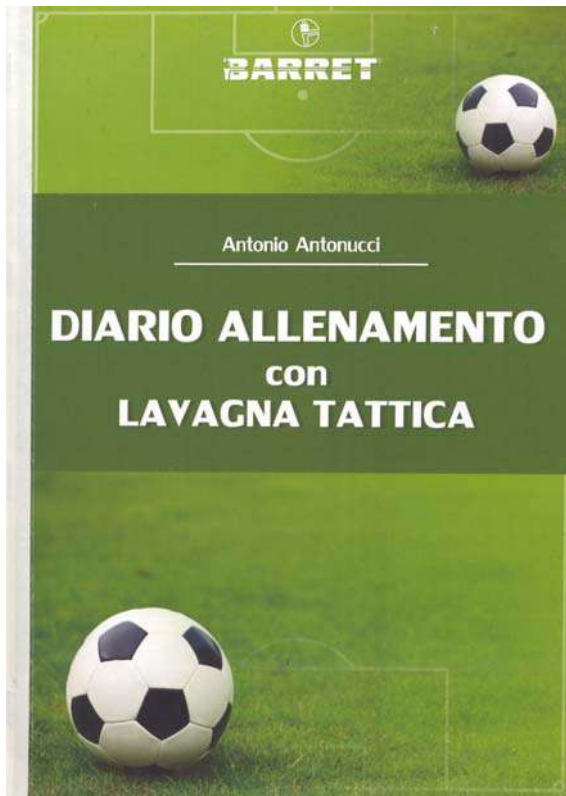

**Art. DALT**  
**DIARIO ALLENAMENTO**

**per l'allenatore di calcio con lavagna tattica**

Lo strumento ideale per programmare e registrare durante il corso della stagione tutto ciò che riguarda la preparazione fisica generale, specifica e speciale, i test di valutazione, la preparazione psico-tattica teorica e pratica, la preparazione psico-cinetica, gli esercizi tecnico-tattici, il riscaldamento, il defaticamento e la preparazione post-infortunio della Vostra squadra di calcio e dei singoli giocatori che la compongono. E' inoltre fondamentale per l'annotazione di tutto ciò che riguarda le partite amichevoli e le partite di campionato, in relazione agli avversari da incontrare.

Il diario è corredato di una retrocopertina pieghevole utilizzabile come lavagna tattica cancellabile a 3 facce

140 pagine



pg.18

Con lavagna cancellabile sulla retrocopertina





**GHIACCIO - TAPE - CREME - OLI**  
Ice - Tape - Creams - Oils



**Art. 164**  
**Ghiaccio spray**  
ml. 400  
Ice spray 400 ml.



**Art. 165**  
**Ghiaccio**  
in busta monouso  
Ice in envelope



**Art. NE2.5**  
**Nastro economico cm. 2,5x13,7 mt**  
Tape cm. 2.5x13,7 mt.

**Art. NE5**  
**Nastro economico cm. 5x13,7 mt**  
Tape cm. 5x13,7 mt.

**Art. N2.5**  
**Nastro tipo Strappal cm. 2,5x10 mt**  
Tape Strappal cm. 2,5x10 mt.

**Art. N5**  
**Nastro tipo Strappal cm. 5x10 mt**  
Tape Strappal cm. 5x10 mt.



**Art. 9254**  
**Salvapelle**  
Skin Protection

pg.17



**Art. IDNC38**  
**Nastro adesivo colorato fermacalze**  
cm. 3,8x13,7 mt.  
colori: rosso, nero, blu, verde e giallo  
Coloured Tape stop stockings  
in red, black, blue, green and yellow



**Art. TPG09**  
**Fraplast cm. 8 (Tensoplast)**



**Art. IPT02**  
**Forbice**  
taglia taping  
in acciaio inox  
Scissors for taping



**Art. T255**  
**Kinesio Tape**



**Art. IPT01**  
**Cutter taglia bendaggi**  
Cutter for bandages





**Art. ONC**  
**Olio riscaldante 500 ml**  
stimola la circolazione,  
tonifica la muscolatura,  
previene le lesioni muscolari  
microtraumatiche  
Oil 500 ml  
for muscle warm up, stimulating  
blood circulation  
and preventing micro injuries



**Art. CNC**  
**Crema riscaldante 250 ml**  
stimola la circolazione,  
tonifica la muscolatura,  
previene le lesioni muscolari  
microtraumatiche  
Cream 250 ml  
for muscle warm up, stimulating  
blood circulation and preventing  
micro injuries



**Art. IRVF**  
**Vaselina filante**  
per curare le zone della pelle a  
maggiore sollecitazione  
Vaseline avoiding skin problems



**Art. IRFA**  
**Fango argilla per impacchi**  
**dopo distorsioni,**  
**per assorbimento ematomi**  
Special mud to be used after  
injuries (i.e. sprained ankles)  
and to absorb bruises

pg.17



**Art. IJGE**  
**Crema Jel Gestic**  
coadiuvante per  
infiammazioni, contusioni  
e lesioni dell'apparato  
muscolare  
Cream Jel Gestic  
for treating minor injuries  
and sore muscles



**T10R**  
**GEL**  
**FREDDO**  
refrigerante  
immediato su  
contusioni o  
strappi muscolari  
Cold Gel for  
immediate  
application on  
bruises and sore  
muscles

**T17G**  
**CUSCINETTO**  
**IN GEL**  
dim. cm.17x27  
(effetto freddo  
ed effetto caldo)  
Gel Pillow  
17x27 cm.  
(both for cold  
and hot therapy)



## BORRACCE - Water Bottles

pg.16

pg.17



**Art. K8**  
**Borraccia da 1 litro**  
**in plastica**  
1 liter plastic Water Bottle

Certificate  
per uso  
alimentare  
Food grade  
certified



**Art. B500ML**  
**Borraccia**  
**da ½ litro**  
**in plastica**  
½ liter plastic  
Water Bottle

**New!**

**Art. BAL1**  
**Borraccia da 1 litro**  
**in alluminio**  
1 liter aluminium Water Bottle



**New!**

**Art. BAL05**  
**Borraccia da ½ litro**  
**in alluminio**  
½ liter aluminium Water Bottle



**New!**

**Art. BTA05**  
**Borraccia termica**  
**da ½ litro in acciaio**  
**mantiene costante la temperatura**  
**del liquido (sia caldo che freddo)**  
½ liter thermic steel Water Bottle  
keeps the liquid temperature  
unchanged

Certificate  
per uso  
alimentare  
Food grade  
certified



**Art. IRTT**  
**Distributore termico 6 litri**  
**con rubinetto**  
Thermos 6 liter with tap





pg.16

pg.17

**Art. 308.C**  
**Cestello per 6 Borracce**  
**in plastica**  
Holder for 6 plastic  
water bottles



**Art. 306**  
**Kit 6 Borracce**  
**da 1 litro in plastica con cestello**  
Kit 6 one liter plastic water bottles  
with holder



**Art. C6B**  
**Cestello per 6 Borracce**  
**in plastica pieghevole**  
Foldable Holder for 6  
plastic water bottles



**Art. KIT6**  
**Kit 6 Borracce da 1 litro**  
**in plastica con cestello pieghevole**  
Kit 6 one liter plastic water bottles  
with foldable holder



**Art. OC8**  
**Cestello per 8 Borracce**  
**in plastica pieghevole**  
Foldable Holder for 8  
plastic water bottles



**Art. K8S6**  
**Kit 8 Borracce**  
**da 1 litro in plastica**  
**con cestello pieghevole**  
Kit 8 one liter plastic water bottles  
with foldable holder



## BANDIERINE - Flags



**Art. 074**  
**Kit completo**  
**4 paletti**  
**calcio d'angolo**  
**con snodo**  
**in PVC Ø mm.32**  
**(bandierine colore**  
**giallo o rosso)**  
**Kit 4 complete**  
**flexible Corner**  
**Poles**  
**in PVC Ø 32 mm.**  
**(yellow or red flags)**



**Art. 074RP**  
**Kit completo**  
**4 paletti**  
**calcio d'angolo**  
**con snodo**  
**rinforzati con tubo**  
**in polipropilene**  
**Ø mm.40**  
**(bandierine colore**  
**giallo o rosso)**  
**Kit 4 complete**  
**flexible Corner**  
**Poles reinforced**  
**with polypropylene**  
**pipe Ø 40 mm.**  
**(yellow or red flags)**

pg.18



**Non utilizzabili**  
**per partite ufficiali**  
**Not for official**  
**matches**

**Art. 073**  
**Kit completo**  
**4 paletti calcio d'angolo**  
**in PVC Ø mm.32**  
**(bandierine colore giallo o rosso)**  
**Kit 4 complete Corner Poles**  
**in PVC Ø 32 mm.**  
**(yellow or red flags)**



**Art. 368**

**Art. 368 Set ricambi**  
**4 Bandierine calcio d'angolo**  
**colore giallo o rosso**  
**Set of 4 spare Corner Flags**  
**yellow or red color**





**Art. 075 / 076**  
**Coppia Bandierine segnalinee gialle o a scacchi con aste in plastica**  
Pair of linesman's Flags yellow or checked with plastic sticks

pg.18



pg.18

**Art. 172**  
**Coppia Bandierine segnalinee elettroniche complete di ricevitore e borsa**  
Pair of electronic linesman's Flags complete with signal receiver and bag



## ACCESSORI ARBITRO - Referee's accessories



**Art. 078**  
Fischio Fox 40 Classic senza pallina  
nero o colorato  
Whistle FOX 40 Classic

**078PD**  
Fischio arbitro senza pallina  
Fox 40 Classic CMG nero o  
colorato con imboccatura  
anatomica e cordino  
Whistle FOX 40 Classic CMG  
cushioned mouth grip  
(cord is included)

pg.18



**Art. 078SK**  
Fischio Fox 40 SONIK BLAST  
CMG con cordino - vari colori,  
con due camere sonore  
Whistle FOX 40 SONIK BLAST  
CMG with cord, various colors



**Art. 078CH**

Fischio senza pallina nero o colorato con cordino in confezione blister  
Plastic whistle without a ball various colors with cord

pg.18



**Art. 228C**  
Fischio in plastica  
nero con cordino  
Plastic black whistle with  
cord

**Art. 228**  
Fischio in plastica nero  
senza cordino  
Plastic black whistle  
without cord



**Art. 079C**  
Fischio cromato  
con cordino  
Chromed brass  
whistle with cord



**Art. FEFOX**  
Fischio elettronico  
Fox 40 con cordino  
potenza 125 dB  
Electronic Fox 40 whistle  
with cord



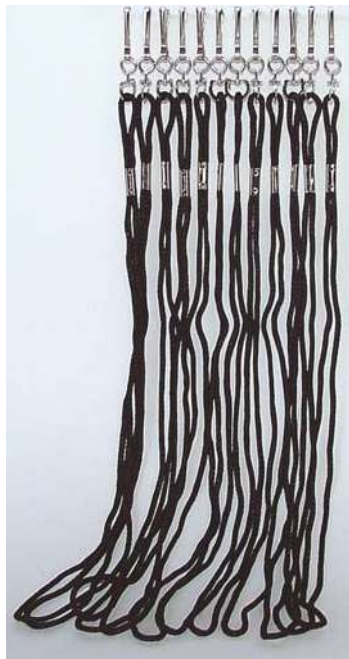

**Art. 080**  
Cordino Lanyard  
colore nero  
Nylon  
whistle cord Lanyard  
black color

pg.18



**Art. F40CAP**  
Cordino Fox antipanico  
regolabile, vari colori  
Fox whistle cord adjustable  
various colors



**Art. 9816**  
Polsino regolabile  
per fischietto Arbitro  
Adjustable wristband  
for referee's whistle



**Art. KCPFOX**  
Kit cronometro da polso e  
fischietto Fox 40 Sonik Blast  
con cordino  
Kit wrist Chronometer with Fox 40  
Sonik blast whistle with cord



**Art. RPC**  
Raccoglitore ad anelli cm.18x15  
per cartellini giocatori  
con 20 buste trasparenti  
Ring binder 18x15 cm. for players'  
cards with 20 transparent envelopes

**Art. RPCRIC**  
Ricambio 10 buste trasparenti per  
raccoglitore ad anelli Art. RPC  
Set of 10 spare envelopes for Art. RPC



**Art. 081F** Coppia cartellini  
giallo e rosso con custodia,  
matita e tabellino gara  
Yellow and red cards with holder,  
pen and game note card



**Art. ZAFN**  
Tabellino gara di ricambio  
per Art. 081F  
Spare game note card for Art. 081F



**Art. GR15**  
Coppia cartellini  
giallo e rosso  
riscrivibili con pennarello  
(cancellabili con alcol)  
Rewritable yellow  
and red cards with pen  
(erasable with alcohol)

pg.18



**Art. RYC02**  
Set 1 cartellino arbitro giallo  
e 1 cartellino arbitro rosso  
Set 1 yellow and 1 red card for referee



**Art. RCB**  
Cartellino arbitro blu  
Blue referee card



**Art. 880147**  
Moneta per arbitro  
in plastica  
rosso/nera  
Referee's coin



## SEGNALATORI MANUALI ED ELETTRONICI PER SOSTITUZIONI Manual and electronic Substitution Boards

**Art. 071**  
Serie numeri cambio giocatori (da 1 a 25) senza manico  
Numbers for substitution (from 1 to 25) without handle



**Art. 072**  
Serie numeri cambio giocatori (da 1 a 25) con manico  
Numbers for substitution (from 1 to 25) with handle



pg.19

**Art. E6230**  
Segnalatore bifacciale economico per cambio giocatori manuale cm.43x38  
Substitution indicator  
1 piece 2 sides

Lato A  
Side A



Lato B  
Side B



Lato B  
Side B

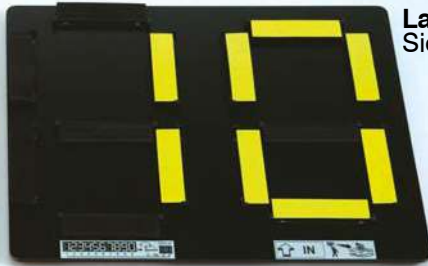
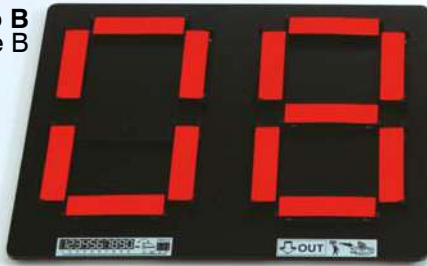

Lato A  
Side A

**Art. C0937**  
Segnalatore bifacciale per cambio giocatori manuale fluorescente - cm.40x32 base in plastica lucida  
Substitution indicator fluorescent 1 piece 2 sides



**Art. F292-30**  
Valigetta cm. 61x40x8  
per Art. FINOUT4 e FINOUT8  
Case 61x40x8 cm. for Art. FINOUT4 and FINOUT8

**Art. FINOUT4**  
Tavoletta elettronica bicolore, monofacciale a 4 cifre (2+2) - led verdi per giocatore entrante led rossi per giocatore uscente, completa di caricabatteria - dim. cm. 58x38x2,7 kg. 2,2  
4 Digit Electronic Substitution Board  
1 side 2 color leds (red and green) cm.58x38x2,7 Kg. 2,2 with battery charger

**Art. FINOUT8**  
Tavoletta elettronica bicolore, bifacciale a 4 cifre (2+2) - led verdi per giocatore entrante led rossi per giocatore uscente, completa di caricabatteria - dim. cm. 58x38x2,7 kg. 2,25  
4 Digit Electronic Substitution Board  
2 sides 2 color leds (red and green) 58x38x2,7 Kg. 2,25 with battery charger



**Art. 065-EC**

**Tavoletta elettronica bifacciale, bicolore  
DELTA 2FE1 cm.46x33x1,8 Kg.1,5  
completa di valigetta e caricabatteria**  
4 digit Electronic substitution Board  
2 sides - 2 color leds (red and green)  
bag and battery charger included

UEFA  
APPROVED



pg.19

**Art. D2FE**

**Tavoletta elettronica  
bifacciale, bicolore DELTA 2FE  
completa di valigetta e caricabatteria**  
cm. 64,5x39x2,5 kg. 2,8  
UEFA Electronic substitution Board  
2 sides - 2 color leds  
bag and battery charger included

UEFA  
APPROVED

UEFA  
APPROVED

**Art. 065-F**

**Tavoletta elettronica approvata UEFA/FIFA  
bifacciale, bicolore a 4 cifre DELTA 2F  
completa di valigetta e caricabatteria**  
led rossi e verdi - cm. 64x39x3 kg. 3  
4 digit UEFA/FIFA Electronic substitution  
Board 2 sides - 2 color leds (red and green)  
bag and battery charger included





## COMPRESSORE - POMPE - MANOMETRI Inflator - Pumps - Gauges



**Art. 106**  
Compressore  
elettrico 220 Volt  
con borsa  
Electric Inflator  
220 Volt  
with bag



pg.19

**Art. 107**  
Manometro misura pressione palloni con valvola  
(con indicazione pressioni consigliate per i vari sport)  
Pressure Gauge with valve  
(with indication of pressure for different sport balls)



**Art. US107**  
Manometro misura pressione palloni alta precisione  
con valvola (con indicazione  
pressioni consigliate per i vari sport)  
High precision pressure Gauge with valve  
(with indication of pressure for different sport balls)



**Art. 104-A** Pompa con ago - Pump with needle



**Art. PSS**  
Pompa a staffa  
con serbatoio  
All purpose  
Pump with tank



pg.19

**Art. 2005**  
Confezione 12 Aghi  
con valvola  
per gonfiatura palloni  
Ø filettatura mm.5  
Set 12 Needles  
with valve  
for inflating balls  
Ø 5 mm. thread

**Art. 2005RC**  
Ago di ricambio  
per compressore Art. 106  
Ø filettatura mm.7,5  
Spare needle  
for electric inflator Art. 106  
Ø 7,5 mm. thread



**Art. 104-T**  
Pompetta in gomma soft  
con ago e valvola di sfiato  
ideale per gonfiatura  
palloni in gomma  
Soft Pump with needle  
and valve  
for inflating rubber balls



**CRONOMETRI - ROTELLE METRICHE - CONTAMETRI**  
**Chronometers - Meter Counter - Measuring Tapes**



**Art. CR032**  
**Cronometro al quarzo a 30 memorie resistente all'acqua**  
 Quartz Chronometer  
 30 memories  
 water resistant

pg.19

**Art. CRN.E**  
**Cronometro digitale**  
 1/100 sec.  
 Digital Chronometer  
 1/100 sec.

**I MODELLI  
 DEI CRONOMETRI  
 POSSONO  
 VARIARE  
 MODELS MAY  
 CHANGE**



**Art. CMT** Contametri fino a m. 9999  
 Meter Counter (until m. 9999)



**Art. CR031**  
**Cronometro al quarzo a 500 memorie resistente all'acqua**  
 Quartz Chronometer  
 500 memories - water resistant

**Art. PR20**  
**Rotella Metrica**  
 in fibra m. 20  
 Fiber measuring tape 20 m.

**Art. PR50**  
**Rotella Metrica**  
 in fibra m. 50  
 Fiber measuring tape  
 50 m.



**Art. PR100**  
**Rotella Metrica**  
 in fibra m. 100  
 Fiber measuring tape 100 m.



## PALLONI CALCIO - Soccer Balls



pg.20

### Art. GPA4 / GPA5

Pallone calcio Gems Viper Olimpico da allenamento in PU n. 4 e n. 5 vari colori

Ball Gems in PU size 4 and 5 various colors



### Art. GPF5

Pallone calcio Gems Viper Olimpico da allenamento in PU n. 5

**GIALLO FLUO**

Ball Gems in PU size 5 fluorescent yellow



### Art. GPRP5

Pallone calcio Gems Raptor da gara in TPU n. 5 (ad esaurimento)

Ball Gems in TPU size 5 (until available)



pg.19

### Art. 1000MS5

Pallone calcio da allenamento Molten misto TPU 1000MS n. 5 (Europa League replica)

Molten training ball TPU size 5 (Europa League replica)



pg.19

### Art. NKPA4 / NKPA5

Pallone calcio Nike Pitch Team colore bianco o arancio n. 4 e n. 5

Nike training ball size 4 and 5



pg.20

### Art. GPRZX

Pallone calcio Gems Raptor ZX da gara FIFA Quality Pro in PU n. 5

Ball Gems in PU size 5



pg.19

### Art. F5V48TR

Pallone calcio Molten n. 5 F5V4800 "Trofeo" per allenamento professionisti e gare ufficiali categorie inferiori

Molten Soccer Ball F5V4800 "Trofeo" size 5



### Art. F5V4800

Pallone calcio Molten n. 5 F5V4800

FIFA approved (ad esaurimento)  
Molten Soccer Ball F5V4800 size 5  
FIFA approved (until available)



## PALLONI CALCETTO, DA PALLEGGIO E SPECIALI - Futsal and rubber balls



**Art. M13189**

pg.21

**Pallone Mondo n. 2  
(ad esaurimento)  
Ball Mondo size 2  
(until available)**



**Art. GPPC3**

**Pallone Gems Bomber  
Primi Calci in TPU n. 3  
Ball Gems in TPU size 3**

pg.20



**Art. GBLD**

**Pallone calcetto Gems  
Blade a rimbalzo  
controllato n. 4  
Futsal Ball Gems size 4**



**Art. GPCV**

**Pallone calcetto Gems Vertigo  
a rimbalzo controllato n. 4  
Futsal Ball Gems size 4**

pg.20



**Art. M390P**

**Pallone calcetto Molten  
modello F9U2000 UEFA  
rimbalzo controllato  
Molten Futsal Ball F9U2000**



**Art. GPC8**

**Pallone calcio a 8 Gems Raptor C8  
in PU n. 4,5  
Ball Gems in PU size 4,5**



**Art. MTHO**

**Pallone calcetto Molten  
modello F9U4800 UEFA  
rimbalzo controllato  
(Thorax)  
Molten Futsal Ball F9U4800**



**Art. 26854**

**Pallone feltro indoor n. 4  
a rimbalzo normale  
Indoor Ball size 4**

pg.20



**Art. 45862**

**Pallone feltro indoor  
n. 4 a rimbalzo controllato  
Indoor slow rebound  
Ball size 4**





pg.20

**Art. ULT46-3**  
**Pallone calcetto**  
**in gomma TRIAL triplo**  
**strato rimbalzo controllato**  
**gr.380 - diam. cm.19,9**  
 Futsal Ball slow rebound  
 Trial rubber



**Art. 1935S**  
**Pallone calcio in gomma**  
**monostrato n. 3**  
**colore giallo**  
 Rubber soccer Ball  
 single stratum size 3  
 color yellow



pg.21

**Art. BYCC**  
**Pallone calcio bicolore**  
**gomma Trial Ø cm.21,5 gr. 420**  
 Trial rubber bicoloured ball



**Art. V45/V44/V42/V41/V40**  
**Palloni calcio in gomma Trial monostrato n. 1 - 2 - 3 - 4 - 5**  
**(misura 5 solo nel colore bianco)**  
 Rubber soccer Balls single stratum Trial size 1 - 2 - 3 - 4 - 5  
 (size 5 only in white color)

pg.20



**Art. ULT42-3/ULT41-3**  
**ULT40-3**  
**Palloni calcio in gomma**  
**Trial triplo strato**  
**n. 3 - 4 - 5**  
 Rubber soccer Balls  
 triple stratum Trial  
 size 3 - 4 - 5

**Art. ULTST3/ULTST4/**  
**ULTST5**  
**Palloni Trial SILVER**  
**STREET n. 3 - 4 - 5**  
**doppio strato**  
 SILVER STREET Trial balls  
 size 3-4-5 double stratum



**Art. TRILO**  
**Pallone calcio Trial**  
**TRILO n. 4,5**  
**doppio strato**  
**limita il trauma dovuto**  
**all'impatto con la palla**  
 Soccer Ball Trial TRILO  
 size 4,5 double stratum  
 softens ball contact



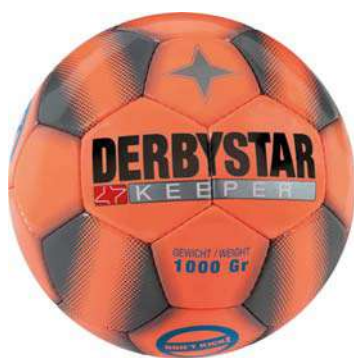

**Art. B703390**

**Pallone in pelle sintetica gr.1000**  
Training Ball  
in synthetic leather 1000 gr.



**Art. ULTS40**

**Pallone in gomma Trial**  
**allenamento potenziato doppio strato**  
Ø cm.21,5 gr.630 (+50%)  
Trial heavy rubber ball double stratum



**Art. ULTD40**

**Pallone in gomma Trial**  
**allenamento potenziato**  
**doppio strato**  
Ø cm.21,5 gr.840 (+100%)  
Trial heavy rubber ball  
double stratum

pg.21



**Art. TRBC**

**Pallone Reaction Ball Trial**  
**doppio strato rimbalzo e traiettorie**  
**imprevedibili per calcio**  
Trial Reaction Ball unpredictable  
rebounds for soccer double stratum



**Art. B703315**

**Pallone per allenamento portieri**  
**rimbalzo irregolare in pelle sintetica**  
Crazy Goalkeeper Ball  
irregular rebounds in synthetic leather



**Art. B703316**

**Reflex ball**  
**pallone prismatico**  
**in pelle sintetica**  
Prismatic ball in  
synthetic leather



pg.20

**Art. 149S14**

**Pallone in**  
**gommapiuma Ø cm. 14**  
Foam rubber ball Ø 14 cm.



**Art. 149S**

**Pallone in**  
**gommapiuma Ø cm. 20**  
Foam rubber ball Ø 20 cm.



pg.21

**Art. E48**

**Pallone sonoro Trial**  
**per non vedenti**  
Ø cm.22 - gr.470  
Trial rattle ball for blind people



## PALLE MEDICHE - Medicine Balls



pg.21

**Art. AHF-105 / AHF-106 /  
AHF-107 / AHF-108 / AHF-109**

**Palle Mediche  
rigonfiabili e rimbalzanti  
Kg. 1 - 2 - 3 - 4 - 5  
ad alto grip colore nero**  
Medicine Balls  
inflatable and rebounding  
high grip in black color



**Art. 048 / 050 / 051 / 052 / 053**

**Palle Mediche rigonfiabili  
e rimbalzanti Trial  
kg. 1 - 2 - 3 - 4 - 5  
(il colore varia  
a seconda del peso)**  
Trial Medicine Balls  
inflatable and rebounding  
different colors for different weights



**Art. PTI.M2 / ... / PTI.M10**

**Palle Mediche con maniglie  
kg. 2 - 4 - 6 - 8 - 10  
(il colore varia  
a seconda del peso)**  
Medicine Balls with handles  
different colors for different weights

**Art. AHF-048/.../AHF-097**

**SLAM BALL  
kg. 2 - 3 - 4 - 5 - 6 - 7 - 8  
9 - 10 - 12 - 15**



pg.22



**Art. AHF-224/.../AHF-232**

**WALL BALL  
kg. 3 - 4 - 5 - 6 - 7 - 8  
9 - 10 - 12**



pg.12

**Art. RVKEB**  
**Rastrelliera verticale  
porta kettlebell/  
palle mediche  
(8 posti)**

8-seater vertical rack  
for cast iron  
Kettlebells/  
Medicine Balls



**Art. KEB4/KEB6/KEB8/KEB10/KEB12/KEB16/KEB20/KEB24**

**Kettlebell in ghisa verniciata con base in gomma  
kg. 4 - 6 - 8 - 10 - 12 - 16 - 20 - 24**  
Painted cast iron Kettlebells - rubber base

**New!**



**Art. OV500 / OV1 / OV2 / OV3 / OV4 / OV5**  
**Over Ball Trial kg.0,5 - 1 - 2 - 3 - 4 - 5  
con impugnatura anatomica**  
Over Ball TRIAL

pg.21



**Art. WMD100 / WMD200  
WMD300 / WMD400 / WMD500**  
**Palle Mediche morbide Bubble  
Trial - kg. 1 - 2 - 3 - 4 - 5**  
Soft Trial Medicine Bubble Balls  
kg. 1 - 2 - 3 - 4 - 5



**Art. POL1 / POL1.5 / POL2 / POL3 / POL3.5**

**POLIBOLO - Over Ball Trial a massa oscillante (riempite con acqua distillata) peso kg.1 - 1,5 - 2 - 3 - 3,5**  
POLIBOLO TRIAL - Over Ball filled with distilled water - weights 1 - 1,5 - 2 - 3 - 3,5 Kg.

**Le Over Ball e le Polibolo possono essere utilizzate sia come manubri sia come palle mediche**  
Over Balls and Polibolos can be used both as dumbbells and medicine balls



## PALLE RITMICHE, PSICOMOTORIE E LUDICHE - Rhythmic and Gym Balls



pg.20

**Art. 518S** Palla Ritmica Mondo gr. 400 (fino ad esaurimento scorte)  
Mondo Rhythmic Ball 400 gr. (until available in stock)



**Art. GS42/GS41/GS40/GS39** Palle Ritmiche Trial - Trial Rhythmic Balls gr. 400-350-250-150



**Ideali per trattamento  
fisioterapico,  
equilibrio, stretching,  
tonificazione, attività  
aerobica, scarico  
vertebrale,  
riscaldamento,  
potenziamento  
muscolare ...**

Very useful for injury  
recovery, equilibrium,  
stretching, muscle  
training, aerobic activity,  
warm up ...



**Art. 30934/30935/30936/31036**

### Palle psicomotorie monostrato

Gym balls single stratum various colors

Ø cm. 55

Ø cm. 65

Ø cm. 75

Ø cm. 85

pg.22



**Art. V10/V11/V12/V13/V14/V15/  
V16/V17/V18/V19**

### Palle psicomotorie Trial in gomma doppio strato (il colore varia a seconda del diametro)

Trial Gym balls  
in double stratum rubber

Ø cm.14-18-22-30

42-53-65-90-120-150

**Art. V-LAB**

### Palla psicomotoria Trial La Ball con range di possibile utilizzo da cm.50 a cm.70

struttura instabile in gomma doppio  
strato particolarmente elastica

Gym ball Trial La Ball

inflatable from 50 to 70 cm.

changing shape concept in very elastic  
double stratum rubber





**Palloni Linea Sun: Ø cm. 26 peso gr. 320 Ø 26 cm. weight 320 grams**

**Il diametro maggiorato favorisce l'apprendimento del bambino - Bigger diameter for youngest training and fun**



**Art. AL01 Big Sun**  
Fase di volo più lenta  
Slower in the air



**Art. AL02 Foot Sun**  
Per stimolare la tattilità del bambino  
To stimulate children's touch



**Art. AL03 Crazy Sun**  
Cambia direzione ad ogni rimbalzo  
Irregular rebounds

pg.21



**Art. ULTbbs3**  
Pallone Jumbo Trial a 3 strati  
diam. cm.28 - gr.280  
Jumbo Trial Ball triple stratum



**Art. BTR1**  
Palla sensoriale Ø cm. 21 - gr. 420  
Sensory Ball Ø cm.21 - gr. 420

Le palle sensoriali rimbalzanti esaltano la tattilità e rappresentano anche uno strumento di automassaggio a pressione  
To stimulate touch and also useful massage tools



**Art. BTR2**  
Palla sensoriale Ø cm.12 - gr. 180  
Sensory Ball Ø cm.12 - gr. 180

pg.20

Allenando la visibilità laterale migliorano la percezione dello spazio, i movimenti e la sicurezza nella vita quotidiana  
For space perception, coordination and everyday life safety

pg.8



**Art. TLV16**  
Palle morbide Trial per allenamento della visibilità laterale Set di 6 Palle diametro cm. 16 gr. 110  
Soft balls for lateral visibility training Set of 6 balls 16 cm. diameter - 110 gr.

**Art. TLV21**  
Set di 6 Palle diametro cm. 21 gr. 160  
Soft balls for lateral visibility training Set of 6 balls 21 cm. diameter - 160 gr.



**Art. BS1T**  
PALLONE BASIC jelly touch Ø 12/16 cm. gr.140 - colore verde  
Basic Ball green color

pg.21

**Art. BS2T**  
PALLONE BASIC jelly touch Ø 16/22 cm. gr.180 - colore arancio  
Basic Ball orange color

**Art. BS3T**  
PALLONE BASIC jelly touch Ø 22/28 cm. gr.240 - colore rosso  
Basic Ball red color



## CESTE PORTAPALLONI - Baskets for balls



**Art. FP400**

**Cesta portapalloni a soffietto in alluminio**  
**cm. 60x60x100h pieghevole con sacca**  
 Basket for balls in aluminium  
 60x60x100h cm. foldable with bag



**Art. F401**

**Cesta Portapalloni in ferro verniciato**  
**cm. 80x55x60h pieghevole**  
 Basket for Balls in painted steel 80x55x60h cm. foldable



pg.22

**Art. F402**

**Cesta Portapalloni**  
**in ferro zincato**  
**cm. 60x60x90h pieghevole**  
 Basket for Balls  
 in galvanized steel  
 60x60x90h cm. foldable

**Art. F404 Cesta Portapalloni**  
**in rete metallica verniciata**  
**cm. 70x70x70h pieghevole**  
**con lucchetto**  
 Basket for Balls  
 painted with metallic net  
 70x70x70h cm.  
 foldable, with lock



**Art. F403G Cesta Portapalloni**  
**in ferro verniciato cm. 100x75x90h**  
**pieghevole con lucchetto**  
 Basket for Balls in painted steel  
 100x75x90h cm. foldable, with lock



**Art. NCPR**

**Sacca portapalloni in nylon**  
**con maniglie, tracolla e ruote**  
 Bag for balls with handles and wheels

pg.23

**Art. F403ZN**  
**Cesta Portapalloni in ferro zincato**  
**cm. 100x75x90h**  
**pieghevole con lucchetto**  
 Basket for Balls in galvanized steel  
 100x75x90h cm. foldable, with lock





## BORSE - Bags

### QUANTITÀ PER MODELLO E COLORE MULTIPLA DI 5 PEZZI

Quantity by model and color  
multiple of 5 pieces

**COLORI DISPONIBILI**  
rosso, royal, navy (no Small),  
nero, verde, bordeaux  
Colors: red, royal, black,  
green, navy (no Small),  
bordeaux



**Art. STD02**  
Borsa Big  
doppio fondo  
cm. 53,5x45h.x32,5  
poliestere 600  
Soccer bag large

**Art. STD09**  
Borsa Medium  
doppio fondo  
cm. 50x42h.x30  
poliestere 600  
Soccer bag medium

**Art. STD03**  
Borsa Small  
doppio fondo  
cm. 47,5x40h.x26,5  
poliestere 600  
Soccer bag small

pg.23

### QUANTITÀ PER COLORE MULTIPLA DI 5 PEZZI

Quantity by color  
multiple of 5 pieces



**Art. STD04**  
Borsa TOP bicolore in poliestere 600 con fondo  
rigido h. 15 cm. con tracolla e porta nome,  
tre tasche, dim. cm. 53,5x45h.x32,5  
colori: navy/royal, nero/grigio, navy/rosso,  
nero/verde, navy/giallo, nero/rosso, nero/bordeaux  
Soccer Bag bicolor in polyester 600 1 pocket  
size 53,5x45h.x32,5 cm.  
colors: navy/royal, black/grey, navy/red, black/green,  
navy/yellow, black/red, black/bordeaux

### QUANTITÀ PER COLORE MULTIPLA DI 15 PEZZI

Quantity by color  
multiple of 15 pieces



**New!**



**Art. STD18**  
Zainetto doppio fondo poliestere 600  
2 tasche - cm. 34x47h.x24 fondo rigido  
colori: royal, nero, rosso,  
navy, verde, bordeaux  
Rucksack in 6 different colors





**Art. STD05**  
**Borsa Portamute cm. 72x35h.x28**  
**poliestere 600 - colore nero**  
Soccer bag for uniforms dim. 72x35h.x28 cm.  
color black

**QUANTITÀ PER COLORE  
MULTIPLA DI 5 PEZZI**

Quantity by color  
multiple of 5 pieces

pg.23



**Art. STD08**  
**Borsa palestra poliestere 600 cm.60x30h.x32**  
**con due tasche e vano portascarpe**  
**colori rosso, royal, navy, nero**  
Gym Bag color black, red, royal, navy



**Art. ZBGL**  
**BORSA/ZAINETTO monocolor economica**  
**cm. 36x38 vari colori - serigrafabile su richiesta**  
Backpack one color with your logo on request



**Art. STD07**  
**Borsa Medica dim. cm. 40x28,5h.x20**  
**poliestere 600 - colore nero**  
Bag for First Aid 40x28,5h.x20 cm.



**Art. BMD**  
**Borsa Medica dim. cm. 37x29h.x17**  
Bag for First Aid 37x29h.x17 cm.



## PORTE CALCIO - Soccer Goals



**Art. SPP45**  
**Set 4 protezioni imbottite**  
 h. cm. 200  
 per paletti posteriori  
 tendirete  
 Set of 4 soft protections  
 200 cm. height  
 for net holder posts

Da abbinare preferibilmente a reti con  
 profondità cm. 170x170 oppure cm.200x200  
 To be combined preferably with nets with  
 depth 170x170 cm. or 200x200 cm.

**Art. SPR45**  
**Set protezioni imbottite**  
 per coppia ribaltine alzarete  
 Set of soft protections  
 for pair of ground backframes

### Art. 109

**Coppia Porte fisse regolamentari in lega leggera costruite secondo lo standard europeo di qualità UNI EN 748 con paletti tendirete posteriori in acciaio zincato, pali sezione mm. 120x100 verniciati con smalto acrilico non tossico, ganci reggirete e bussole per interrimento pali incluse (ribaltine alzarete non incluse)**

Pair of regular Goals in light alloy manufactured according to the UNI EN 748 European standard of quality norms. Pipe section 120x100 mm. painted with non toxic white. Net holders, rear posts and underground sockets included (liftable ground backframes not included)

pg.23

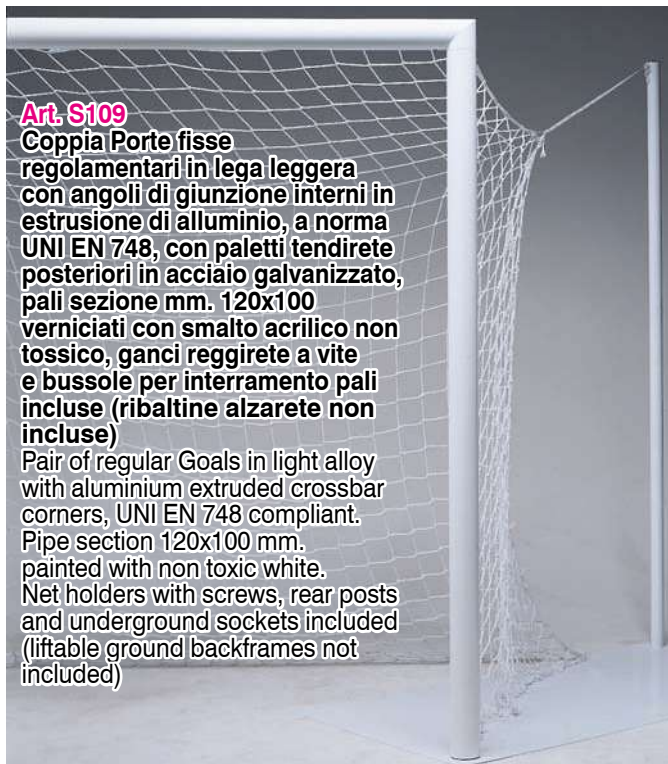

**Art. S109**  
**Coppia Porte fisse**  
 regolamentari in lega leggera  
 con angoli di giunzione interni in  
 estrusione di alluminio, a norma  
 UNI EN 748, con paletti tendirete  
 posteriori in acciaio galvanizzato,  
 pali sezione mm. 120x100  
 verniciati con smalto acrilico non  
 tossico, ganci reggirete a vite  
 e bussole per interrimento pali  
 incluse (ribaltine alzarete non  
 incluse)  
 Pair of regular Goals in light alloy  
 with aluminium extruded crossbar  
 corners, UNI EN 748 compliant.  
 Pipe section 120x100 mm.  
 painted with non toxic white.  
 Net holders with screws, rear posts  
 and underground sockets included  
 (liftable ground backframes not  
 included)

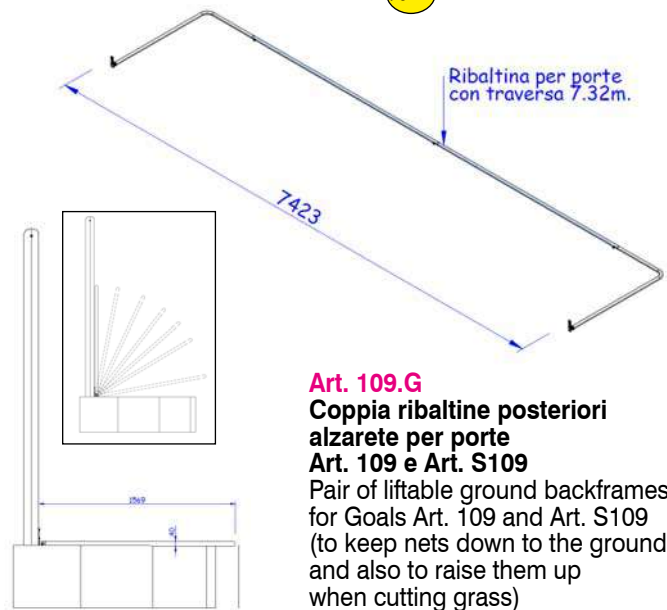

**Art. 109.G**  
**Coppia ribaltine posteriori**  
 alzarete per porte  
**Art. 109 e Art. S109**  
 Pair of liftable ground backframes  
 for Goals Art. 109 and Art. S109  
 (to keep nets down to the ground  
 and also to raise them up  
 when cutting grass)

**ATTENZIONE: in caso di ordine errato da parte del Cliente le porte, una volta consegnate, non possono essere rese**

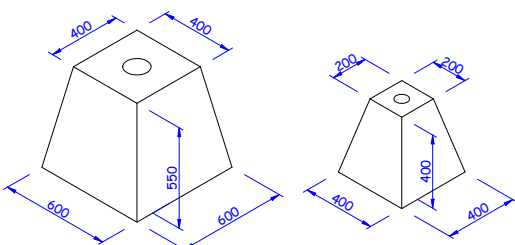

**Ancoraggio tramite**  
**plinti in cemento**  
**(non inclusi)**  
 Fixing with concrete blocks  
 (not included)

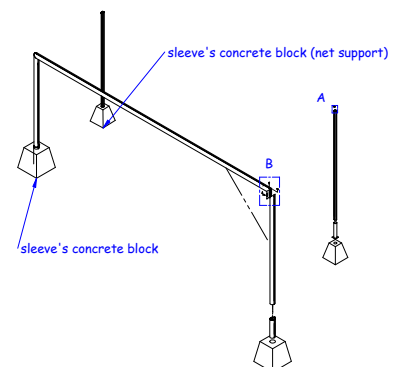





Da abbinare preferibilmente a reti con profondità cm. 100x200  
To be combined preferably with nets with depth 100x200 cm.



**Art. 110FG** Coppia Porte Trasportabili in lega leggera dimensioni regolamentari profilo sezione mm. 120x100 verniciate con smalto acrilico non tossico base di appoggio posteriore con tubo tondo in ferro - a norma UNI EN 748  
Pair of transportable Goals in light alloy regular size, pipe section mm. 120x100 painted with non toxic white - back frame in round iron pipe - UNI EN 748 standard



**Art. 120-RG**  
**Coppia ruote per porte trasportabili regolamentari Art. 110FG, 110-D e 110G**  
Pair of wheels for regular size transportable goals  
Art. 110FG, 110-D and 110G



Da abbinare preferibilmente a reti con profondità cm. 100x200  
To be combined preferably with nets with depth 100x200 cm.

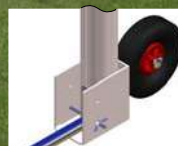

pg.24

**LE PORTE TRASPORTABILI IN FASE DI GIOCO DEVONO ESSERE ZAVORRATE SULLA BASE POSTERIORE O FISSATE A TERRA CON PICCHETTI PER MOTIVI DI SICUREZZA. LE RUOTE GOMMATE SONO OPTIONAL**

Transportable goals must always be anchored to the ground by sacs of sand or metal pegs, for safety reasons. Wheels are optional

**Art. 110-D**  
**Coppia Porte Trasportabili dim. regolamentari in lega leggera profilo sezione mm. 120x100 - verniciate con smalto acrilico non tossico base di appoggio posteriore con profilo ovale in alluminio mm. 65x55 - a norma UNI EN 748**  
Pair of transportable Goals in light alloy regular size, pipe mm. 120x100 painted with non toxic white - back frame in aluminium oval pipe 65x55 mm.



**Art. AMCP**

**Carrello per il trasporto di porte (trasportabili) regolamentari e ridotte - brevettato**  
Patented trolley for moving official and junior size transportable goals

pg.26





Da abbinare preferibilmente a reti con profondità cm. 100x200  
To be combined preferably with nets with depth 100x200 cm.

**Art. 110G** Coppia Porte Trasportabili in lega leggera dimensioni regolamentari profilo mm. 120x100 verniciate con smalto acrilico non tossico, base di appoggio posteriore con profilo in lega mm. 120x100 - a norma UNI EN 748 e FIGC  
Pair of transportable Goals in light alloy regular size, pipe mm. 120x100, painted with non toxic white - back frame pipe 120x100 mm. - UNI EN 748 and FIGC standard



**Art. 110GMR** Set 4 ruote per porte trasportabili regolamentari Art. 110G (2 set per 1 coppia di porte). Ciascuna ruota in dotazione ha una posizione di riposo e una posizione di trasporto (per passare dall'una all'altra occorre far ruotare il dispositivo intorno al perno). Dunque, le ruote restano sempre fissate al telaio posteriore della porta

Set of 4 wheels for regular size transportable goals Art. 110G (2 set for 1 pair of goals). Each wheel remains fixed to the back ground frame also when goals are in use, in stand by position. To switch the wheel into transport position you have to turn it around the pivot

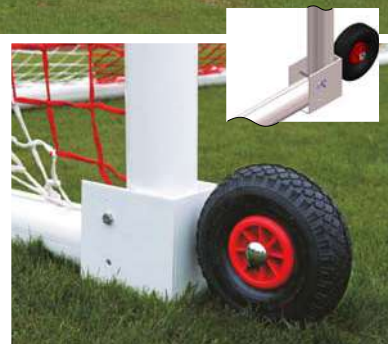

pg.24

**Art. 120-RG**  
Coppia ruote per porte trasportabili regolamentari Art. 110FG, 110-D e 110G  
Pair of wheels for regular size transportable goals Art. 110FG, 110-D and 110G

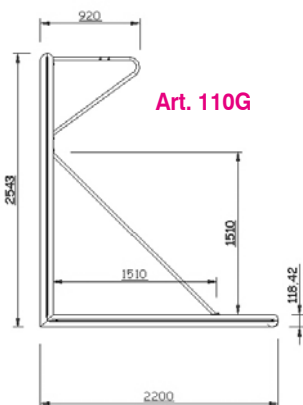

Art. 110G

**Art. 4580M**  
Mollone per ancoraggio porte trasportabili regolamentari e ridotte su terreno naturale  
Spring for goal anchoring on natural grass

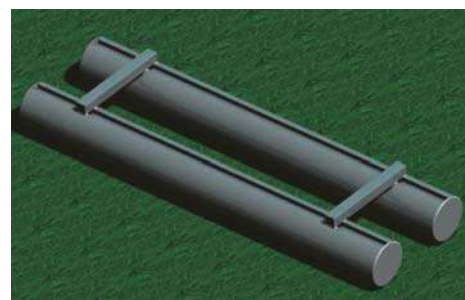

**Art. AFC**  
Zavorra in alluminio per ancoraggio porte trasportabili regolamentari e ridotte  
Aluminium weighted pipes for goal anchoring

**ATTENZIONE: in caso di ordine errato da parte del Cliente le porte, una volta consegnate, non possono essere rese**

pg.26

**Art. DSSCE**  
Sacco zavorra vuoto (da riempire con sabbia) per ancoraggio porte trasportabili regolamentari e ridotte  
Empty Ballast Bag (to be filled with sand) for goal anchoring



**Art. DSS20**  
Sacco zavorra kg. 20 (riempito con sabbia) per ancoraggio porte trasportabili regolamentari e ridotte  
Ballast Bag weight 20 Kg. for goal anchoring



**Porte fisse (con bussole e pali da interrare) e trasportabili in lega leggera o acciaio, sezione tubo mm. 120x100 o mm.80 - dimensioni m. 3x2 - m. 4x2 - m. 5x2 - m. 6x2**  
 Fixed and transportable Goals in light alloy or painted steel, pipe section 120x100 mm. or 80 mm. dimensions m. 3 x 2 - m. 4 x 2 - m. 5 x 2 - m. 6 x 2

pg.24 pg.25



Art. 114-T  
 Art. 118-G  
 Art. 116-TDV  
 Art. 120-TG

Con distanziale a terra posteriore in tubo tondo  
 With round pipe ground base

**ATTENZIONE: in caso di ordine errato da parte del Cliente le porte, una volta consegnate, non possono essere rese**

**Art. 114-T**  
**Coppia Porte m. 4 x 2 a traversa intera in acciaio trasportabili tubo sezione 80 mm.**  
 Pair of Goals m. 4 x 2 - 1 piece crossbar in painted steel, transportable, pipe 80 mm.

**Art. 118-G**  
**Coppia Porte m. 4 x 2 a traversa intera in lega di alluminio trasportabili tubo sezione 80 mm.**  
 Pair of Goals m. 4 x 2 - 1 piece crossbar in light alloy, transportable, pipe 80 mm.

**Art. 116-TDV**  
**Coppia Porte m. 5 x 2 a traversa divisa in lega di alluminio trasportabili tubo 80 mm.**  
 Pair of Goals m. 5 x 2 - crossbar in 2 pieces in light alloy, transportable, pipe 80 mm.

**Art. 120-TG**  
**Coppia Porte m. 6 x 2 a traversa divisa in lega di alluminio trasportabili tubo sezione 80 mm.**  
 Pair of Goals m. 6 x 2 - crossbars in 2 pieces in light alloy, transportable, pipe 80 mm.

**Art. 118A**  
**Coppia Porte m. 4 x 2 a traversa divisa in lega di alluminio trasportabili tubo 80 mm. con base posteriore a sezione quadra**  
 Pair of Goals m. 4 x 2 - crossbars in 2 pieces in light alloy, transportable, pipe 80 mm. with square pipe ground bases

**Art. 1129A**  
**Coppia Porte m. 5 x 2 a traversa divisa in lega di alluminio trasportabili tubo 80 mm. con base posteriore a sezione quadra**  
 Pair of Goals m. 5 x 2 - crossbars in 2 pieces in light alloy, transportable, pipe 80 mm. with square pipe ground bases

**Art. 1121A**  
**Coppia Porte m. 6 x 2 a traversa divisa in lega di alluminio trasportabili tubo 80 mm. con base posteriore a sezione quadra**  
 Pair of Goals m. 6 x 2 - crossbars in 2 pieces in light alloy, transportable, pipe 80 mm. with square pipe ground bases



Art. 118A  
 Art. 1129A  
 Art. 1121A

Da abbinare esclusivamente a reti con profondità cm. 100x160  
 To be combined only with nets with depth 100x160 cm.

Base posteriore a sezione quadra  
 Reinforced ground base

**LE PORTE TRASPORTABILI IN FASE DI GIOCO DEVONO ESSERE ZAVORRATE SULLA BASE POSTERIORE O FISSATE A TERRA CON PICCHETTI PER MOTIVI DI SICUREZZA. LE RUOTE GOMMATE SONO OPTIONAL**  
 Transportable goals must always be anchored to the ground by sacs of sand or metal pegs, for safety reasons. Wheels are optional



**Art. 120-R**  
**Coppia ruote per porte trasportabili ridotte Art. 118A, 1129A, 1121A**  
 Pair of wheels for reduced size transportable goals Art. 118A, 1129A, 1121A

pg.25



**Art. 4640**  
**Coppia ruote per porte trasportabili ridotte Art. 114-T, 118-G, 116-TDV, 120-TG**  
 Pair of wheels for reduced size transportable goals Art. 114-T, 118-G, 116-TDV, 120-TG



Le porte ridotte sono disponibili anche nel modello fisso con pali e bussole da interrare  
 Available also fixed models with underground sockets





**Art. 119G Coppia Porte m. 5 x 2 a traversa divisa in acciaio trasportabili tubo 80 mm.**  
 Pair of Goals m. 5 x 2 crossbar in 2 pieces in painted steel, transportable, pipe 80 mm.

**Art. 120-G Coppia Porte m. 6 x 2 a traversa divisa in acciaio trasportabili tubo sezione 80 mm.**  
 Pair of Goals m. 6 x 2 crossbars in 2 pieces in painted steel, transportable, pipe 80 mm.

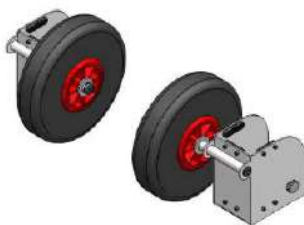

pg.24 pg.25

**Art. 241C Chiave per kit di fissaggio Art. 240AF**  
 Key for ground anchoring kit Art. 240AF



**Art. 240RU Coppia ruote gommaste con staffa per porte Art. 119G/120-G**  
 Pair of wheels for transportable goals Art. 119G/120-G

**Art. 240AF Kit di fissaggio a terra per porte Art. 119G/120-G**  
 Ground anchoring kit for transportable goals Art. 119G/120-G

**ATTENZIONE:**  
 in caso di ordine errato da parte del Cliente le porte, una volta consegnate, non possono essere rese



**Art. 122G Coppia Porte Calcetto m. 3 x 2 trasportabili in acciaio verniciato tubo sezione 80 mm.**  
 Pair of Goals m.3x2 transportable in painted steel pipe 80 mm.

**Art. 121G Coppia Porte Calcetto m. 3 x 2 trasportabili in lega leggera tubo sezione 80 mm.**  
 Pair of Goals m.3x2 transportable in light alloy pipe 80 mm.

pg.25

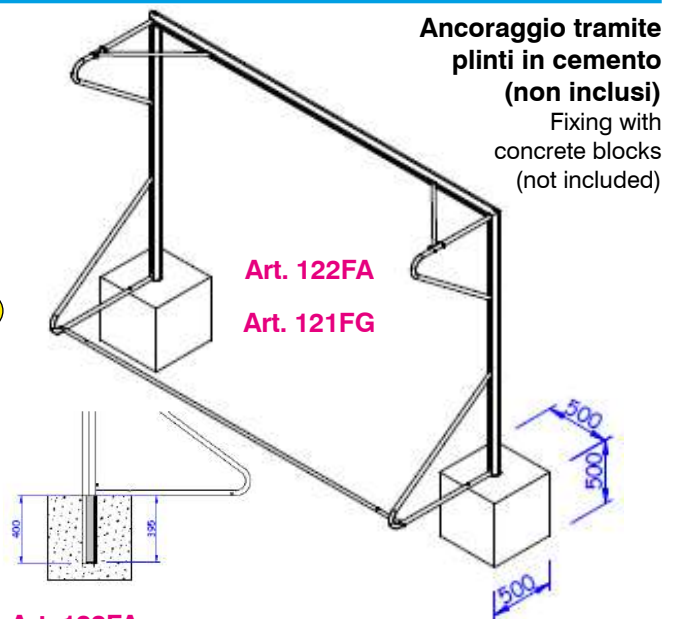

**Art. 122FA Coppia Porte Calcetto m. 3 x 2 fisse con bussole da interrare in acciaio verniciato tubo 80 mm.**  
 Pair of Goals m.3x2 fixed in painted steel pipe 80 mm.

**Art. 121FG Coppia Porte Calcetto m. 3 x 2 fisse con bussole da interrare in lega leggera tubo 80 mm.**  
 Pair of Goals m.3x2 fixed in light alloy pipe 80 mm.



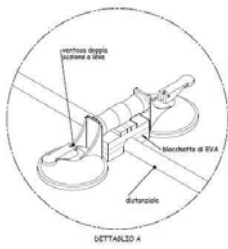

**Art. VTCL**  
**Ventosa doppia per ancoraggio a terra**  
**porte calcetto su superfici indoor lisce**  
**(si consigliano 2 kit per ciascuna porta)**  
 Ground anchoring suckers for reduced goals  
 to be used upon indoor smooth floors  
 (it takes 2 kits for every goal)

pg.25

pg.26



**Art. DSSCE**  
**Sacco zavorra vuoto**  
**(da riempire con sabbia)**  
**per ancoraggio**  
**porte trasportabili**  
**regolamentari e ridotte**  
 Empty Ballast Bag  
 (to be filled with sand)  
 for goal anchoring



**Art. DSS20**  
**Sacco zavorra kg. 20**  
**(riempito con sabbia)**  
**per ancoraggio**  
**porte trasportabili**  
**regolamentari e ridotte**  
 Ballast Bag weight 20 Kg.  
 for goal anchoring

**Art. PC04**  
**Picchetto in alluminio**  
**per ancoraggio**  
**di porte ridotte**  
**con distanziale sottile**  
**su terreno naturale**  
 Aluminium anchoring hook  
 for reduced soccer goals  
 with thin pipe ground bases

**Art. AM01.7/.../AM01.3**  
**TUBO ZAVORRA in PVC diametro 50 mm. atossico,**  
**flessibile, modellabile, appesantito da composto**  
**ecologico (peso 6 Kg. per metro) resistente alle alte e**  
**basse temperature e ai raggi ultravioletti**  
**per porte ridotte mt. 3x2/4x2/5x2/6x2**  
**e regolamentari sia fisse che trasportabili**  
 Weighted soft Pipe 50 mm. diameter  
 (6 Kg. per meter) resistant to high/low  
 temperatures and ultra violet rays  
 for safe anchoring of transportable goals  
 m. 3x2/4x2/5x2/6x2 and official size goals  
 to the ground

pg.26



**Art. 353.G10 (modello 2010)**



**Art. 353.G13 (modello 2013)**

**Art. 353.G10 / 353.G13**  
**Serie 100 ganci reggirete di**  
**ricambio modello a rotazione**  
**per porte regolamentari o ridotte**  
 100 spare Net Holders  
 rotating model for regular  
 and reduced goals



pg.25

**Art. 353 Serie 100 ganci reggirete**  
**di ricambio modello con vite per porte**  
**regolamentari o ridotte**  
 100 spare Net Holders with screws  
 for regular and reduced goals



**Art. V590010**  
**Serie 100 ganci**  
**reggirete**  
**di ricambio**  
 100 spare  
 Net Holders



**Art. V680011 Serie 100 ganci**  
**reggirete di ricambio**  
**a base rotonda da fissare con viti**  
 100 spare Net Holders

**ATTENZIONE: verificate la tipologia dei ganci**  
**delle Vostre porte prima di ordinare i ricambi**  
 Please check the model of your holders  
 before ordering spares



**Art. GFG**  
**Gancio**  
**reggirete**  
**in ferro con**  
**piastrina**  
**di ricambio**  
 Spare iron  
 Net Holder



**Art. SC1051**  
**Serie 100 ganci**  
**reggirete**  
**di ricambio**  
 100 spare  
 Net Holders



**Art. 110BAG**  
**Serie 60 ganci**  
**reggirete**  
**di ricambio**  
 60 spare  
 Net Holders





pg.25

Ideali per uso  
privato  
Not for official  
matches

**Art. SG176**  
**Porta m. 3x2 trasportabile**  
**in ferro verniciato,**  
**tubo sezione mm. 32**  
**completa di rete, ganci e**  
**picchetti**  
3x2 meter transportable  
Goal in painted iron, pipe  
section 32 mm. complete  
with net, hooks and pegs

**ATTENZIONE: in caso di ordine errato da parte del Cliente**  
**le porte, una volta consegnate, non possono essere rese**

**PORTE BIFRONTALI in lega leggera o acciaio dimensioni m. 3x2 - 4x2 - 6x2**  
Available 2 SIDE GOALS in light alloy or in painted steel dimensions m. 3 x 2 - 4 x 2 - 6 x 2

pg.26



**Art. 084**  
**Porta bifrontale**  
**m. 4 x 2**  
**in lega leggera**  
**sezione tubo 50 mm.**  
**completa di rete**  
Two Side Goal  
4 x 2 m. in light alloy  
pipe 50 mm.  
net included

**Art. 084AC**  
**Porta bifrontale**  
**m. 4 x 2**  
**in acciaio verniciato**  
**sezione tubo 50 mm.**  
**completa di rete**  
Two Side Goal  
4 x 2 m. in painted  
steel, pipe 50 mm.  
net included

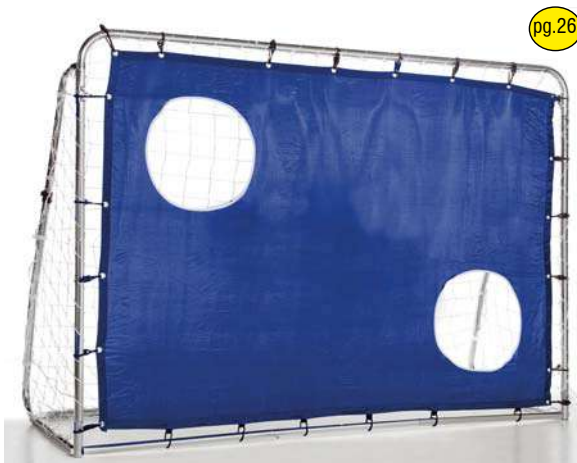

pg.26



**Art. IS215**  
**Miniporta in acciaio m. 2,15 x 1,52 completa di rete, parete con bersagli e rete di rimbalzo**  
Steel Mini-goal m. 2,15 x 1,52 - net, PVC target and rebounding net included



## MINI PORTE Mini-goals



**Art. F214**  
**Coppia Miniporte professionali in acciaio verniciato tubo sezione 80 mm. dimensioni m. 1,5 x 1 complete di reti**  
Pair of professional steel Mini-goals pipe 80 mm. dimensions m. 1,5 x 1 nets included

pg.26



**Art. F218**  
**Coppia Miniporte professionali in acciaio verniciato tubo sezione 80 mm. dimensioni cm. 90x60 complete di reti**

Pair of professional steel Mini-goals pipe 80 mm. dimensions 90x60 cm. nets included



**Art. 123C**

**Coppia Miniporte in acciaio verniciato m. 1,5 x 1 complete di reti e picchetti**  
Pair of Mini-goals m. 1,5 x 1 in painted steel pegs and nets included



**Art. 123F**

**Coppia Miniporte in acciaio verniciato m. 1,5 x 1 complete di reti e picchetti**  
Pair of Mini-goals m. 1,5 x 1 in painted steel pegs and nets included

pg.26



**Art. 124C**  
**Coppia Miniporte m. 1,5 x 1,1 in PVC rinforzato tubo Ø 70 mm. complete di reti e picchetti**  
Pair of PVC Mini-goals m. 1,5 x 1,1 pipe Ø 70 mm. pegs and nets included





**Art. PUG**  
**Coppia Miniporte in nylon**  
**m. 1,83 x 1,07**  
**complete di reti,**  
**picchetti e borsa**  
Pair of nylon Mini-goals  
1,83 x 1,07 m.  
nets, pegs and bag included

pg.26



**Art. P124**  
**Coppia Miniporte**  
**in PVC m. 1,5x1,1**  
**tubo Ø 32 mm.**  
**complete di reti**  
Pair of PVC Mini-goals  
m. 1,5x1,1  
pipe Ø 32 mm.  
nets included



**Art. 124** Coppia Miniporte in  
polipropilene  
m. 1,5x1,1 tubo Ø 40 mm.  
complete di reti  
Pair of polypropylene Mini-goals  
m. 1,5x1,1 pipe Ø 40 mm.  
nets included



pg.26

**Dimensioni porte ribaltate**  
**m. 1,5 x 0,80**  
Goal upside down  
dimensions 1,5 x 0,80 m.



**Art. A124**  
**Coppia Miniporte in alluminio** m. 1,5 x 1,1  
**tubo Ø 32 mm. complete di reti**  
Pair of aluminium Mini-goals m. 1,5 x 1,1  
pipe Ø 32 mm. - nets included



**Dimensioni Porta ribaltata m. 1,5 x 0,80**  
Goal upside down dimensions 1,5 x 0,80 m.



## PORTE E MINIPORTE FLESSIBILI - Flexible goals and mini-goals



**Art. FLEX1.5**

**Porta minicalcio m. 1,5 x 0,90 flessibile in vetroresina completa di rete e picchetti - peso Kg. 3,5 tempo di assemblaggio 1 minuto**

Flexible fiberglass Mini-Goal size 1,5x0,9 mt. with net and pegs - weight 3,5 Kg. set up time 1 minute

pg.26



**Art. S.BAGS**

**Coppia di sacchi zavorra da riempire con sabbia per l'ancoraggio delle porte Art. FLEX1.5 su terreni sintetici**

Pair of sandbags (sand not included) for anchoring goals Art. FLEX1.5 on turf or synthetic grass

**Art. FLEX.3**

**Porta calcetto m.3x2 flessibile con struttura in vetroresina, completa di rete e picchetti (non necessita dell'utilizzo di zavorre) peso Kg.12,5**

**tempo di assemblaggio 2 minuti dimensioni imballo cm. 129x30x17**

Flexible fiberglass Futsal Goal size 3x2 mt.

with net and pegs - weight 12,5 Kg. (sandbags not required) set up time 2 minutes



- Velocissime da assemblare
- I montanti in vetroresina flettono e tornano immediatamente in posizione al momento del goal o dell'impatto con la palla
- Facili da smontare e trasportare
- Leggerezza e minimo ingombro

- Quick set up
- Fiberglass poles flex and pop up straight after goal
- Easy to take down and carry
- Low weight and volume

pg.26



**Art. FLEX7**

**Porta calcio regolamentare flessibile con struttura in vetroresina completa di rete e base di appoggio autoportante, utilizzabile sia su terreni naturali che sintetici peso Kg. 21 (non necessita dell'utilizzo di zavorre)**

**tempo di assemblaggio 3 minuti in 2 persone - dimensione imballo cm. 167x35x23**

Flexible fiberglass official size Goal with net, ready for use on grass or turf (sandbags not required) Weight 21 Kg. - set up time 3 minute 2 people



## RETI DI PROTEZIONE - Protection nets



**TUTTE LE RETI DI PROTEZIONE VENGONO REALIZZATE SU MISURA IN BASE ALLE RICHIESTE DEL CLIENTE IN CIRCA 10 GIORNI**

All protection nets are manufactured according to Customer's needs in about 10 days

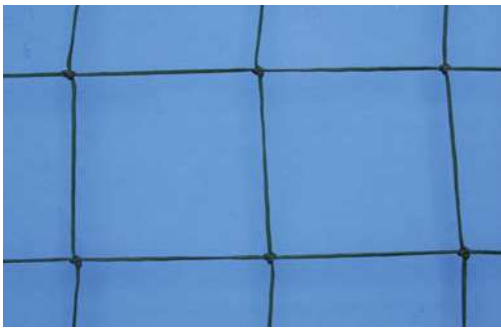

● pg.28

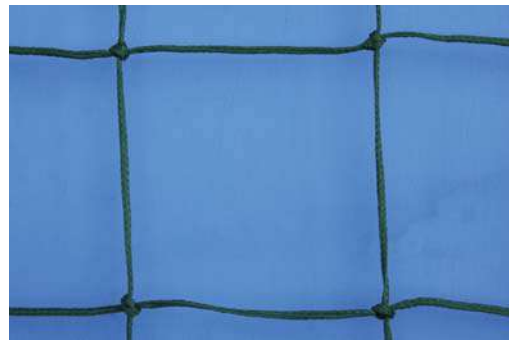

**Art. 093N**  
**Rete protezione polietilene verde annodata**  
**maglia cm. 13x13 sp. mm.2,5**  
**(per calcio e calcetto)**  
Protection Net green polyethylene mesh  
13x13 cm. knotted, thickness 2,5 mm.

**Art. 093.5**  
**Rete protezione polietilene verde**  
**annodata maglia cm. 13x13 sp. mm.3,5**  
**(per calcio e calcetto)**  
Protection Net green polyethylene mesh  
13x13 cm. knotted, thickness 3,5 mm.



**Art. 0934N**  
**Rete protezione**  
**polietilene verde annodata**  
**maglia mm. 45x45 sp. mm.2**  
**(per tennis e baseball)**  
Protection Net green  
polyethylene mesh  
4,5x4,5 cm. knotted, thick 2 mm.  
(for tennis and baseball)

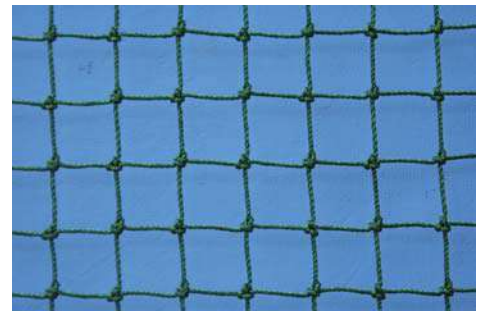

**Art. R55**  
**Rete protezione polietilene**  
**nera maglia mm.18**  
**annodata sp. mm.2**  
**antioggetto / antipetardo**  
Protection Net  
anti-objects and fire crackers

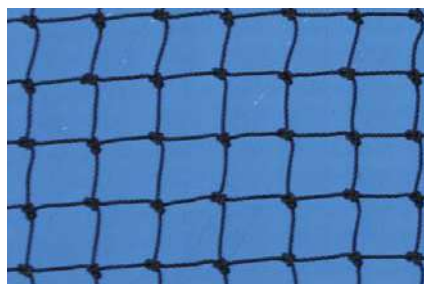

**Art. R57**  
**Rete protezione polietilene verde maglia**  
**mm.25x25 sp. mm.3 (per golf)**  
Protection Net for golf



**RETI REGOLAMENTARI - Regular Nets**

Le reti a maglia esagonale sono tessute, quelle a maglia quadrata sono annodate (eccetto Art. B011)  
 Square mesh nets are knotted (except Art. B011)



**Art. B011**  
 polipropilene mm.5  
 maglia mm.120 mesh  
 colore bianco  
 white  
 certificate FIGC/LND  
 certified  
 profondità  
 cm.200x200 depth

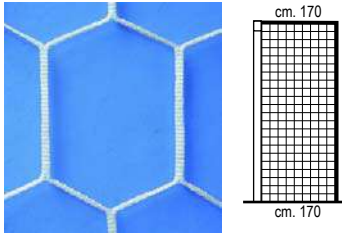
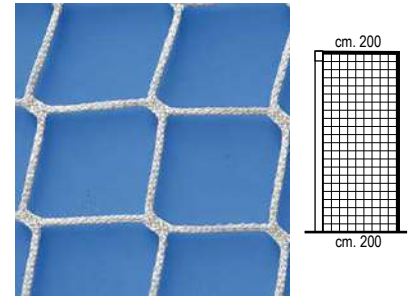

**Art. 125E**  
 polipropilene mm. 3  
 profondità  
 cm.170x170 depth

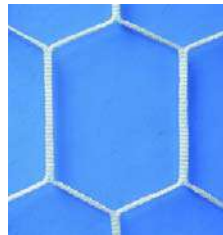

**Art. 125**  
 polipropilene mm. 4  
 profondità  
 cm.170x170 depth

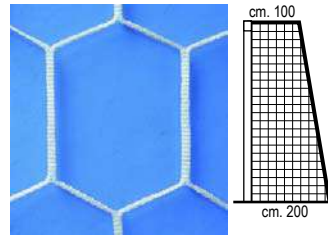

**Art. 126**  
 poliestere mm. 5  
 profondità  
 cm.100x200 depth

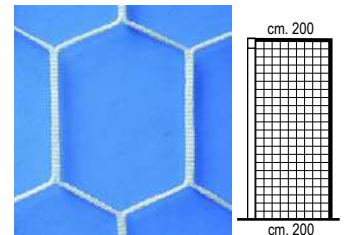

**Art. 127**  
 polipropilene mm. 5  
 profondità  
 cm.200x200 depth

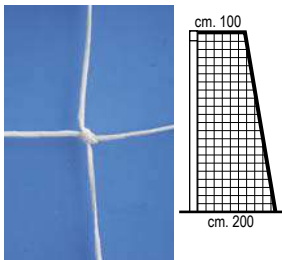

**Art. B19**  
 polietilene sp.mm.3,5  
 profondità  
 cm.100x200 depth

pg.27



**Art. 128E**  
 polietilene sp.mm.3,5  
 profondità  
 cm.200x200 depth

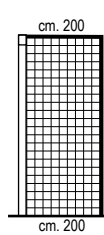

**Art. 128**  
 polietilene sp.mm.4,5  
 profondità  
 cm.200x200 depth



**Profondità:**  
 la prima grandezza indica  
 la sporgenza posteriore  
 della rete  
 ad altezza traversa,  
 la seconda grandezza  
 indica quella a terra  
 Depth: the first figure indicates  
 the rear depth of the net at  
 crossbar level, the second  
 figure indicates the rear depth  
 at ground

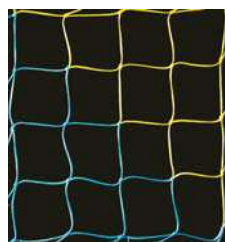

**Art. 128FR** Coppia reti annodate in polietilene mm.4 bianche o a strisce colorate (bianco-royal, bianco-rosso, giallo-royal) profondità cm.100x200 depth  
 Pair of nets polyethylene 4 mm. color stripes, knotted (available in white, white-royal, yellow-royal, white-red)

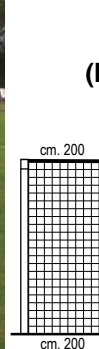
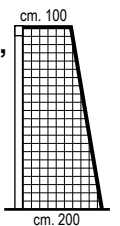

**Art. 128C** Coppia reti annodate in polietilene mm.3,5 a strisce colorate (bianco-royal, bianco-rosso, giallo-royal, rosso-blu, bianco-nero, bianco-verde) profondità cm.200x200 depth  
 Pair of nets polyethylene 3,5 mm. color stripes, knotted (available in white-royal, yellow-royal, white-red, white-black, white-green, red-blue)



**Art. 129T**  
 Coppia reti polipropilene mm.6 annodate a mano a strisce colorate (consigliabile per combinazioni di colori alternative a quelle degli Art.128FR e 128C) profondità cm.200x200 depth  
 Pair of nets with color stripes, hand knotted in various combinations





**RETI RIDOTTE - Reduced Size Nets - m.4x2/m.5x2/m.6x2/m.6x2,2/m.6,5x2,5**

**Profondità: la prima grandezza indica la sporgenza posteriore della rete ad altezza traversa, la seconda grandezza indica quella a terra**

**Depth: the first figure indicates the rear depth of the net at crossbar level, the second figure indicates the rear depth at ground**

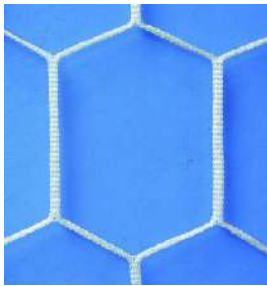

**Art. 133**  
**Coppia Reti m. 4x2**  
**in polipropilene mm. 4**  
**profondità cm.120x120**  
 Pair of nets 4x2 m. Polipropilene mm. 4 thickness cm.120x120 depth

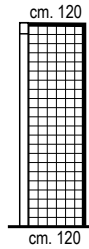

**Art. 133SN**  
**Coppia Reti m. 4x2**  
**annodate in polietilene mm. 2,5**  
**profondità cm.100x100**  
 Pair of knotted nets 4x2 m. polietilene thickness 2,5 mm. cm.100x100 depth

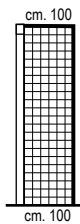
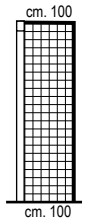

**Art. 133LR**  
**Coppia Reti m. 4x2**  
**annodate in polietilene spessore mm. 3,5**  
**profondità cm.100x100**  
 Pair of knotted nets 4x2 m. polietilene thickness 3,5 mm. cm.100x100 depth



**Art. 133NP**  
**Coppia Reti m. 4x2**  
**annodate in polietilene spessore mm. 3,5**  
**profondità cm.100x160**  
 Pair of knotted nets 4x2 m. polietilene thickness 3,5 mm. cm.100x160 depth

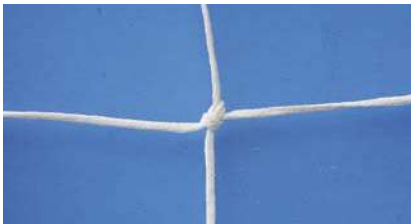
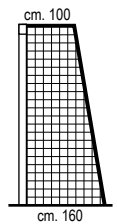

**Art. 132N**  
**Coppia Reti m. 5x2**  
**annodate in polietilene mm. 2,5**  
**profondità cm.120x120**  
 Pair of knotted nets 5x2 m. polietilene thickness 2,5 mm. cm.120x120 depth

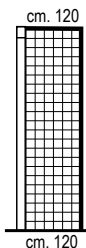

pg.27



**Art. B171**  
**Coppia Reti m. 5x2**  
**annodate in polietilene mm. 3,5**  
**profondità cm.100x160**  
 Pair of knotted nets 5x2 m. polietilene thickness 3,5 mm. cm.100x160 depth

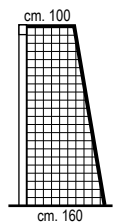

**Art. 131N**  
**Coppia Reti m. 6x2**  
**annodate in polietilene mm. 2,5**  
**profondità cm.120x120**  
 Pair of knotted nets 6x2 m. polietilene thickness 2,5 mm. cm.120x120 depth

**Art. B170**  
**Coppia Reti m. 6x2**  
**annodate in polietilene mm. 3,5**  
**profondità cm.100x160**  
 Pair of knotted nets 6x2 m. polietilene thickness 3,5 mm. cm.100x160 depth

**Art. 131.22**  
**Coppia Reti m. 6x2,2**  
**annodate in polietilene mm. 3,5**  
**profondità cm.100x160**  
 Pair of knotted nets 6x2,20 m. polietilene thickness 3,5 mm. cm.100x160 depth

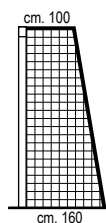

**Art. 131.5**  
**Coppia Reti m. 6,50x2,50**  
**in polipropilene mm. 4**  
**profondità cm.120x120**  
 Pair of nets 6,50x2,50 m. Polipropilene mm. 4 thickness cm.120x120 depth

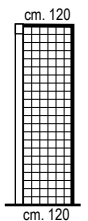
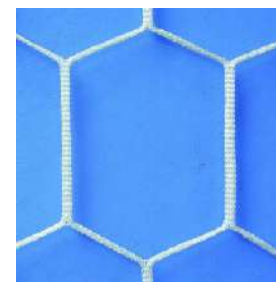



## RETI CALCETTO - Futsal Nets m. 3x2

**Profondità cm.100x100**  
Depth: 100x100 cm.

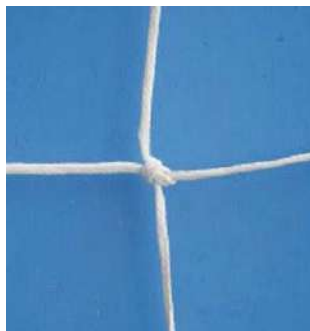

**Art. 134E**  
Coppia reti m.3x2 annodate in polietilene spessore mm.2,5  
Pair of 3x2 meter nets knotted polietilene thickness 2,5 mm.



**Art. 135C**  
Coppia reti m.3x2 annodate in polietilene spessore mm.3,5  
Pair of 3x2 meter nets knotted polietilene thickness 3,5 mm.

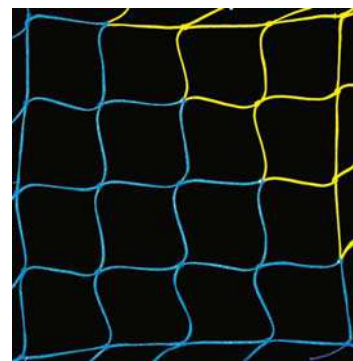
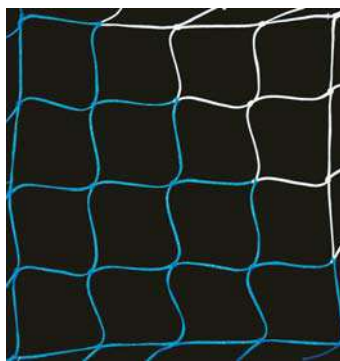
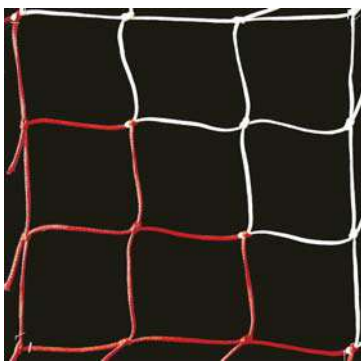
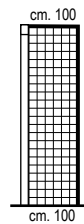

**Art. 135FR** Coppia reti m.3x2 annodate in polietilene spessore mm.3 colori: bianco-royal, bianco-rosso, giallo-royal  
Pair of 3x2 meter nets knotted polietilene thickness 3 mm. colors: royal/white, red/white, yellow/royal

pg.28

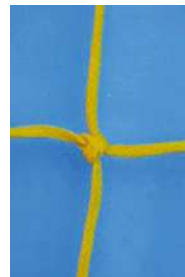

**Art. 135** Coppia reti m.3x2 annodate in polietilene spessore mm.4,5 colori: rosso, bianco, giallo  
Pair of 3x2 meter nets knotted polietilene thickness 4,5 mm. Colors: red, yellow or white



**Art. 137**  
Coppia reti **m.1,5x1,1** per Miniporte  
Pair of nets 1,5x1,1 m. for Mini-goals

## RETI PORTAPALLONI - Ball sacs



**Art. 041-6 / 041-12 / 041-18**  
Reti Portapalloni in polipropilene senza nodo (da 6, 12 o 18 palloni)  
Nets for balls in polypropylene (for 6, 12 or 18 balls)



**S041-6 / S041-12 / S041-18**  
Reti Portapalloni in polipropilene con nodo (da 6, 12 o 18 palloni)  
Knotted Nets for balls in polypropylene (for 6, 12 or 18 balls)

pg.28

**Art. SM20**  
Sacca Portapalloni in nylon 420/PVC capienza 20 palloni  
Ball Sac for 20 balls





## RETI PER CALCI DI PRECISIONE - Precision shooting nets

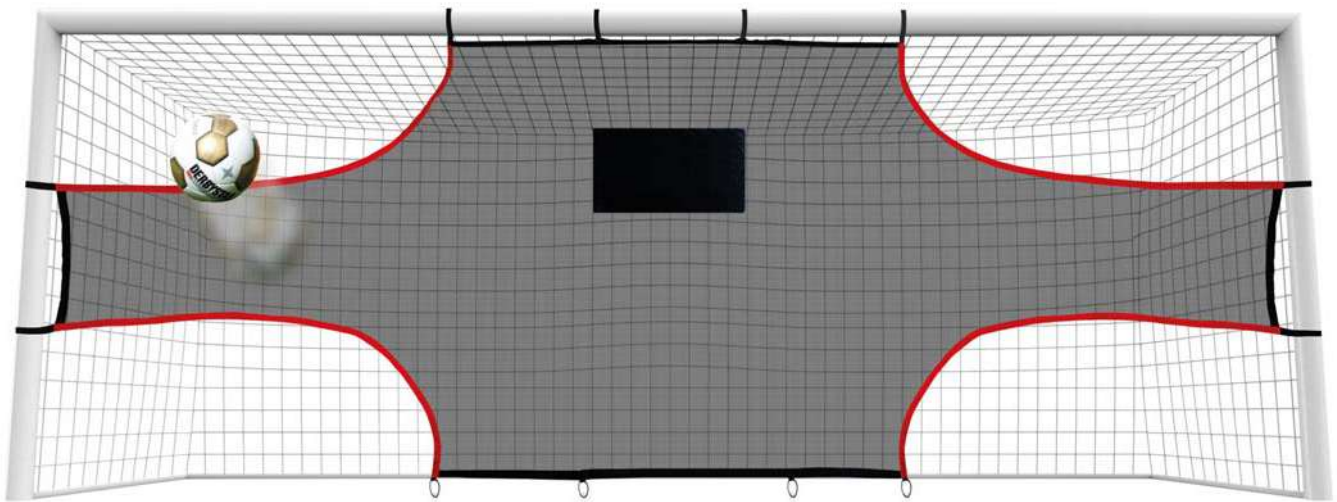

Art. PTI.732

**Rete bersaglio per porta regolamentare completa di fasce con velcro per fissaggio a pali e traversa e picchetti per ancoraggio a terra**

pg.28

Target net for regular size goal complete with velcro straps for fixing to poles and crossbar and pegs for ground anchoring

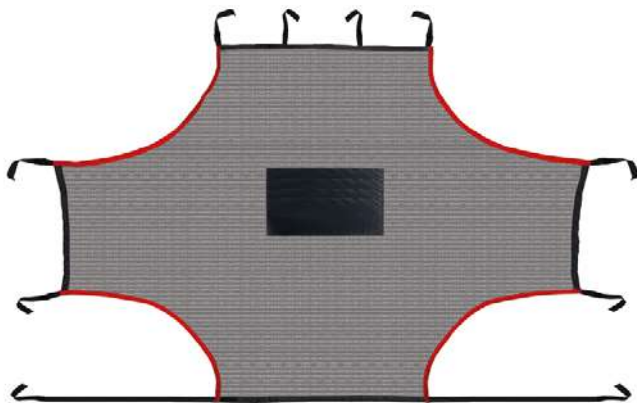

pg.28

Art. PTI.275

**Rete bersaglio per porta m.3x2 completa di fasce con velcro per fissaggio a pali e traversa e picchetti per ancoraggio a terra**

Target net for futsal goal complete with velcro straps for fixing to poles and crossbar and pegs for ground anchoring

pg.28

**4 tasche bersaglio per calci di estrema precisione**



**4 target pockets for very accurate shootings**

*Basta raccogliere palloni in fondo al sacco, lascia che sia la palla a tornare da te!*

*Stop picking up balls all the time, let the ball come back to you!*

Art. GM

**Rete respingente con 4 tasche per calci di precisione completa di corda elastica e picchetti da applicare a porta regolamentare**  
Special net with 4 accuracy pockets including elastic rope and pegs for regular size goal

Art. GM42

**Rete respingente con 4 tasche per calci di precisione completa di corda elastica e picchetti da applicare a porta m. 4x2**  
Special net with 4 accuracy pockets including elastic rope and pegs for m. 4x2 goal





**New!**

pg.28

**ART. 05020785**

**Set bande elastiche per allenamento ai tiri di precisione - completo di borsa impermeabile composto da 3 strisce orizzontali + 3 verticali + 2 strisce bianche per utilizzo su superfici sintetiche + 3 sacchi per sabbia (da riempire) + accessori per il fissaggio - da applicare a porta regolamentare**  
 Straps for flexible marking of target zones for official size goal

Set of 3 horizontal bands + 3 vertical bands  
 + 2 bands (white) for indoor use, on artificial turf etc. + 3 sandbags (without sand) + fixing accessories  
 Packed in a waterproof bag



**Art. QBF**  
**CROSS TRAINING**  
 rete bersaglio  
 sempre in piedi per  
 allenamento alla  
 precisione del cross,  
 del lancio in  
 profondità,  
 del rinvio del portiere  
 CROSS TRAINING  
 movable target to  
 improve crossing, long  
 passing and GK kicks  
 precision

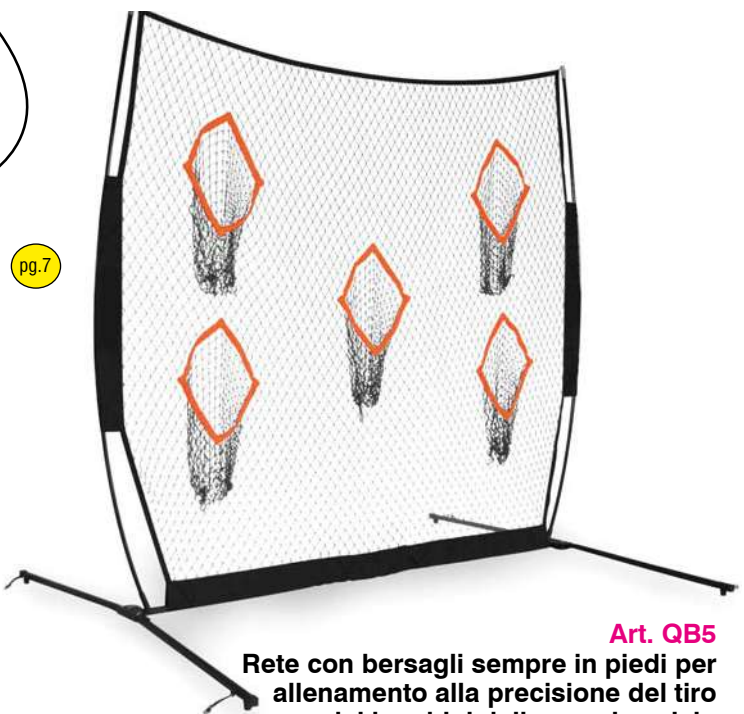

**Art. QB5**  
**Rete con bersagli sempre in piedi per  
 allenamento alla precisione del tiro  
 dei bambini delle scuole calcio**  
 Net with 5 targets - always standing movable  
 device to improve soccer school kids'  
 precision shooting

**Il bersaglio ha dimensioni cm.120x120, ha una inclinazione regolabile da orizzontale a quasi verticale ed è in grado di ricevere la palla ad altezze comprese tra cm.190 e cm.250 senza mai cadere a terra - peso Kg.10 facilmente spostabile sul campo**

The basket is adjustable from horizontal to nearly vertical height adjustable from 190 to 250 cm. weight 10 Kg. - very easy to move on the field, never falls down when hit by the ball

**La rete ha dimensioni cm.240x240 ed un peso di Kg.13 - facilmente spostabile sul campo, impossibile da abbattere a terra**  
 Net dimensions 240x240 cm.  
 weight 13 Kg.

very easy to move on the field, never falls down when hit by ball



## PANCHINE ALLENATORI - Trainers' dug-outs



Panchina allenatori profilo curvato mm. 50x30 in acciaio zincato a caldo  
**Art. V6230 e seguenti**  
rivestimento posteriore in policarbonato alveolare non trasparente spessore mm. 4, fianchi rivestiti in policarbonato trasparente mm. 3, piano di seduta con scocche in polipropilene montate su telaio zincato

Altezza tettuccio cm. 200, profondità fianco laterale cm. 88

● pg.29

Panchina allenatori profilo curvato mm. 50x30 in acciaio zincato a caldo  
**Art. V6220 e seguenti**  
rivestimento posteriore e laterale in policarbonato trasparente spessore mm. 3, piano di seduta con scocche in polipropilene montate su telaio zincato



**Art. V6285**  
Protezione in poliuretano espanso per bordo panchina allenatori con profilo mm. 50x30

● pg.30

**Art. V6288**  
Coppia ruote da applicare a panchina con profilo mm. 50x30 al fine di renderla trasportabile







Altezza tettuccio cm. 200 profondità fianco laterale cm. 74  
Roof height 200 cm. - side depth 74 cm.



**Art. 155AV/156AV/157AV/158AV/159AV/159.7AV/159.8AV/155AV4**

**Panchina allenatori con struttura in tubo quadro in lega d'alluminio mm. 30x30 con copertura in policarbonato alveolare non trasparente - fianchi laterali in policarbonato trasparente (2 scocche di seduta in polipropilene per ogni metro di lunghezza)**

**Dug-out in light alloy square pipe mm. 30x30 with non transparent alveolar protection  
Transparent protection on both sides (2 polypropylene seats per every meter of length)**

pg.30

*È possibile sostituire le scocche con le panche a listoni in legno con schienale senza variazioni di prezzo  
Available wooden benches with back in spite of seats, at the same price*



*È necessario fissare le panchine su una base in cemento tramite tasselli: la base dovrà essere più estesa di circa 30 cm. per ciascun lato rispetto alla lunghezza e alla profondità della panchina.*

*It is necessary to anchor dug-outs upon concrete base. Size of concrete base must be about 60 cm. longer and deeper than dug-out perimetric size (30 cm. longer and wider on each of the 4 sides)*





Altezza tettuccio cm. 200 profondità fianco laterale cm. 74  
Roof height 200 cm. - side depth 74 cm.



**Art. 155/156/157/158/159/159.7/159.8/155-4**

**Panchina con struttura in tubo quadro in lega d'alluminio mm. 30x30 con copertura in policarbonato trasparente e scocche di seduta in polipropilene (2 scocche di seduta per ogni metro di lunghezza)**  
Dug-out in light alloy square pipe mm. 30x30 with transparent polycarbonate protection  
(2 polypropylene seats per every meter of length)

pg.30

La verniciatura con colore a richiesta del tubo quadro in alluminio comporta una maggiorazione del prezzo del 10%  
Optional painting of the square pipe frame in aluminium (color on request): 10% additional charge on selling price

È possibile sostituire le scocche con le panche a listoni in legno con schienale senza variazioni di prezzo  
Available wooden benches with back in spite of seats, at the same price

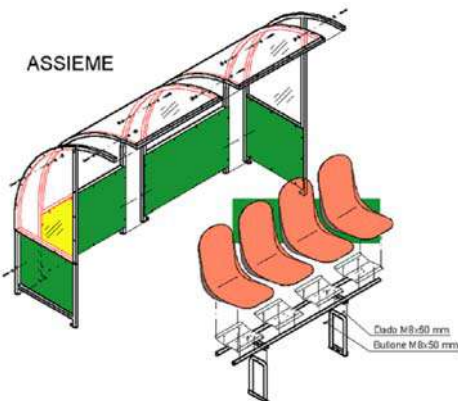

**Art. ASBI**  
**Seduta ricambio per panchina allenatori colore rosso o blu, fissaggio con 4 viti**  
Spare Seat for Dug-Outs in red or blue color, fixing with 4 screws

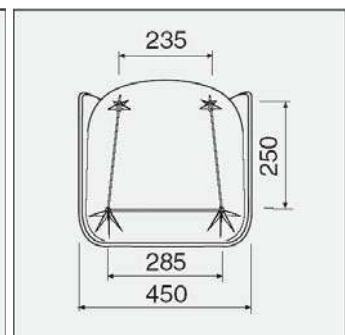
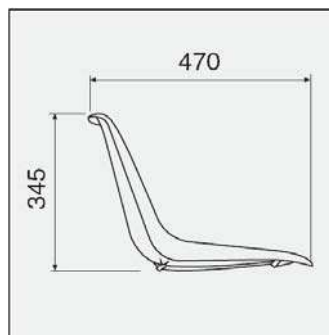

È necessario fissare le panchine su una base in cemento tramite tasselli: la base dovrà essere più estesa di circa 30 cm. per ciascun lato rispetto alla lunghezza e alla profondità della panchina  
It is necessary to anchor dug-outs upon concrete base. Size of concrete base must be about 60 cm. longer and deeper than dug-out perimetric size (30 cm. longer and wider on each of the 4 sides)





**Art. 155FZ2/155FZ4/155FZ6/155FZ8**

**Panchina allenatori in acciaio zincato a caldo rinforzato profilo mm. 40x40 con profondità cm.180 (misurando da tettuccio a limite base posteriore di appoggio) rivestita con lastre in policarbonato trasparente spessore mm. 3 piano di seduta con scocche in polipropilene Mondo Seat 6**

Dug-Out in galvanized steel pipe 40x40 mm. - 180 cm. depth (from back protection to edge of roof)  
transparent polycarbonate 3 mm. thick back cover - polypropylene seats on steel frame (2 seats each meter)



**Art. 155PR**

**Rivestimento di protezione in schiumato per tettuccio e montanti**  
Soft edge protections

pg.30

pg.31



**Art. LXR2/LXR4/LXR6/LXR8**

**Panchina allenatori in tubo di acciaio zincato a caldo profilo mm. 40x40 TRASPORTABILE su ruote - copertura in policarbonato trasparente profondità cm. 135 piano di seduta con scocche in polipropilene Mondo Seat 6**

Dug-Out in galvanized steel pipe 40x40 mm. - TRANSPORTABLE on wheels  
transparent polycarbonate back cover polypropylene seats



## PANCHINE ALLENATORI IDEALI PER CAMPI CALCETTO Trainers' dug-outs for futsal pitches



**Panchina allenatori profilo curvato  
mm 40x20 in lega di alluminio  
rivestimento posteriore e laterale  
in policarbonato alveolare sp. mm. 4  
profondità a terra cm. 97,  
altezza massima cm. 208  
lunghezza metri 2 oppure metri 3  
con panca sedute  
in acciaio zincato e legno  
Art. V6242.2 e Art. V6242.3  
o con panca sedute  
in alluminio anodizzato  
Art. V6241.2 e Art. V6241.3**

● (pg.31)



Dug-out curved profile  
40x20 mm. in light alloy  
rear and side coverings  
in non transparent polycarbonate  
4 mm. thick  
soil depth 97 cm.  
maximum height 208 cm.  
2 meters or 3 meters length  
with wooden bench on  
galvanized steel  
**Art V6242.2 and V6242.3**  
or with bench in  
anodized aluminium  
**Art V6241.2 and V6241.3**



## PANCHINE ALLENATORI IDEALI PER CAMPI CALCETTO Trainers' dug-outs for futsal pitches



Panchina allenatori trasportabile su ruote, profilo curvato mm. 50x30 in lega di alluminio rivestimento posteriore e laterale in policarbonato alveolare sp. mm. 4 **Art. V6291** oppure in policarbonato trasparente sp. mm. 3 **Art. V6292** profondità a terra cm. 150, altezza utile cm. 210 lunghezza metri 3 con supporto sedute in acciaio zincato e 6 scocche in polipropilene con piano borse sul retro dei seggiolini

pg.31

Dug-out transportable on wheels curved profile 50x30 mm. in light alloy rear and side coverings in non transparent polycarbonate mm. 4 thick **Art V6291** or in transparent polycarbonate mm. 3 thick **Art V6292** depth on the ground 150 cm. useful height 210 cm. length 3 meters with galvanized steel seat support and 6 polypropylene seats with back space for bags



**Art. S04910**  
Panchina bordo campo struttura in acciaio zincato lunghezza cm. 200 con 4 scocche di seduta in polipropilene colorato  
4 Sideline seats on galvanized steel frame length 200 cm.

pg.42



## PANCHINE LUSO CON SEDUTE IN ECOPELLE - Leather seat dug-outs

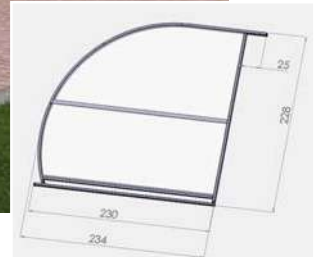

**PREVENTIVO SU RICHIESTA  
PRICES ON REQUEST**

**Modelli fissi o trasportabili  
struttura in acciaio zincato  
poltrone in ecopelle personalizzabili**  
Fixed or transportable Dug-Outs  
galvanized steel frame  
customizable leather seats

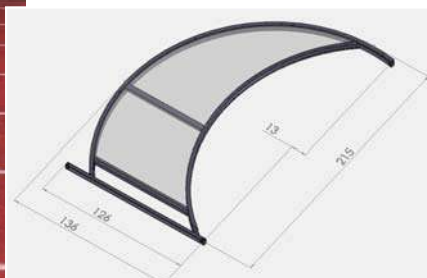





**Art. 146**

**Vernice Ecologica atossica per manti erbosi Linea Stadio**  
 lt. 15 - Kg. 19 ad alto rendimento  
 Ecological Paint for grass 15 liters - 19 Kg.

pg.29



**Art. 146E**

**Vernice Ecologica atossica per manti erbosi Biancostadio** lt. 17 - Kg. 19  
 Ecological Paint for grass 17 liters - 19 Kg.



**Art. NTESA**

**Rotolo Nastro adesivo mt. 50 - h. 5 cm.**  
 vari colori per tracciatura righe su superfici sintetiche  
 Tape for bounds  
 50 meter - 5 cm. height

**Art. SIFS**

**Fettuccia segnasettore in materiale sintetico impermeabile colore bianco o rosso**  
 larghezza mm. 50 in rotoli da m. 25 (chiodi inclusi)  
 Sector line in waterproof synthetic fabric, width 50 mm. length 25 m. color white or red (pegs included)



**Art. 146BP/146BPG**

**Vernice bianca o gialla per manti sintetici a bassa permanenza (1 settimana) 17 litri**  
 Paint for artificial grass white or yellow color, short durability (1 week) 17 liters



**Art. 146LP/146LPG**

**Vernice bianca o gialla per manti sintetici a lunga permanenza (3 mesi) 17 litri, da utilizzare solo con carrello a rulli**  
 Paint for artificial grass white or yellow color, long durability (3 months) 17 liters



**Art. ELP2/ELP4**

**Elasticone per divisione spazi h. cm. 2 oppure h. cm. 4 lunghezza mt. 20, completo di 2 moschettoni**  
 Elastic bound 2 cm. height or 4 cm. height - length 20 meters - with 2 hooks



**Art. NS200**

**Rotolo nastro stradale mt. 200 - bianco/rosso**  
 Red/White Tape length 200 meters



**Art. PFIx Plifix**

**Picchetto di riferimento permanente con erba sintetica bianca o colorata, per agevolare la tracciatura delle righe dei campi di gioco o per delimitazione aree**  
 Confezione da 25 pezzi  
 utensile in plastica incluso  
 Plifix - permanent peg with artificial white or coloured grass to help tracing lines on the field or mark areas  
 25 pieces set includes also plastic planting device

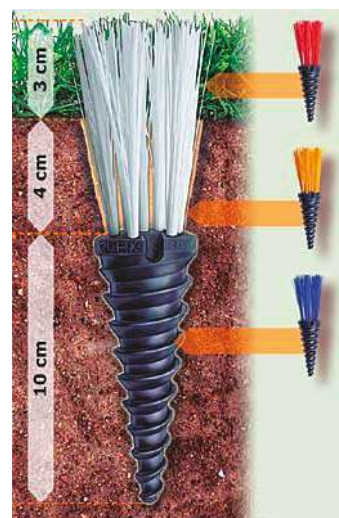



## CARRELLI TRACCIALINEE - Line markers

**Per una resa ottimale e per evitare inconvenienti utilizzare sempre carbonato di calcio asciutto, ovvero la comune polvere di marmo**

For optimal performance always use dry calcium carbonate, that is the common marble dust



pg.28

### Art. 142S

**Carrello traccialinee a polvere**

Marble Powder Line Marker

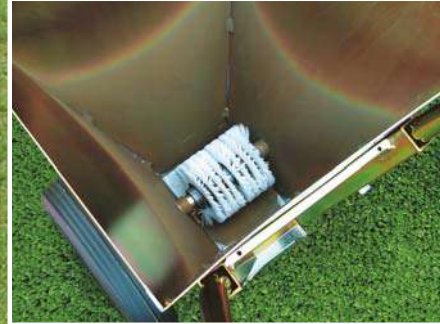

**UTILIZZARE SOLTANTO VERNICE ECOLOGICA ATOSSICA E PULIRE DOPO OGNI USO IL SERBATOIO E TUTTO IL CIRCUITO DI SPRUZZO FINO AGLI UGELLI (occorre spruzzare ripetutamente acqua prima di riporre l'attrezzo)**  
Always use ecological paint and wash with water after use (put water in the tank and spray)

**Nuove ruote antifango in dotazione new anti-mud wheels**



**Art. 144**  
**Carrello traccialinee a vernice ecologica con serbatoio munito di pompante a pressione manuale**  
Paint Line Marker with manual pressure tank

pg.28

Particolare  
leva pressione  
spruzzo



### Art. 145

**Carrello traccialinee a vernice ecologica con motore a scoppio a miscela**

**serbatoio vernice lt.25 tracciatura laterale regolabile**  
Paint Line Marker

with 2 stroke engine  
25 liter tank





**Art. 144.EL**

**Carrello traccialinee a vernice elettrico completo di caricabatteria (per la batteria della pompa elettrica) capacità serbatoio litri 18 tracciatura laterale regolabile**  
Electric Line Marker complete with battery charger 18 liter tank adjustable lateral marking device

pg.28

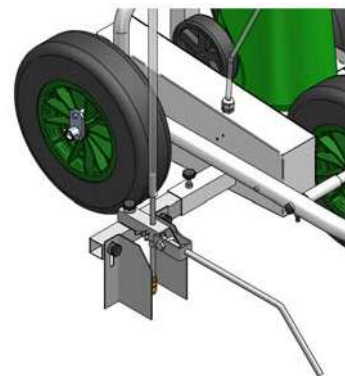

**Art. F211**

pg.29

**Mirino in acciaio zincato per carrelli traccialinee Art. 144.EL ed Art. 145**  
Foresight in galvanized steel for line markers Art. 144.EL and Art. 145

pg.28

**Art. 144.SL**

**Carrello traccialinee a rulli senza serbatoio a pressione né motore a scoppio. Tramite la rotazione dei rulli, la vernice viene prelevata all'interno del serbatoio e spalmata sull'erba.**

Roller Paint Line Marker  
Just fill up the tank with paint and push the machine.  
Taking advantage of rolling wheels, paint flows from tank down to grass the easiest way!





## SEDUTE PER GRADINATE - Stadium seats

**COLORI DISPONIBILI: blu, rosso, giallo, verde, bianco, nero, grigio**  
**AVAILABLE COLORS: blue, red, yellow, green, white, black, grey**

**ORDINE MINIMO 10 PEZZI PER MODELLO E COLORE**  
**Minimum quantity 10 pieces per model and color**

**ATTENZIONE:  
 NON PER PANCHINE  
 ALLENATORI!  
 NOT FOR TRAINERS'  
 DUG-OUTS!**



**Art. M2003/M2003A**

**Art. M2003 Seduta in polipropilene con schienale ignifuga e antiultravioletti (secondo normativa UEFA) fissaggio diretto sulla gradinata con tasselli (non inclusi)**  
 Polypropylene Seat non ignitable and anti-ultraviolet rays with back rest (according to UEFA requirements) to be fixed with screws (not included)

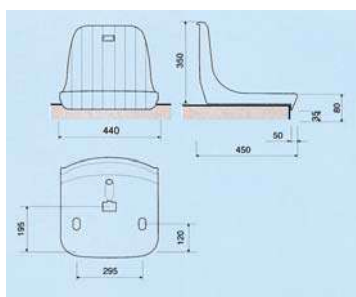

**Art. M2003A Seduta in polipropilene con schienale come Art. M2003 solo antiultravioletti, fissaggio diretto sulla gradinata con tasselli (non inclusi)**  
 Polypropylene Seat as Art. M2003 anti-ultraviolet rays, with back rest to be fixed with screws (not included)

pg.31

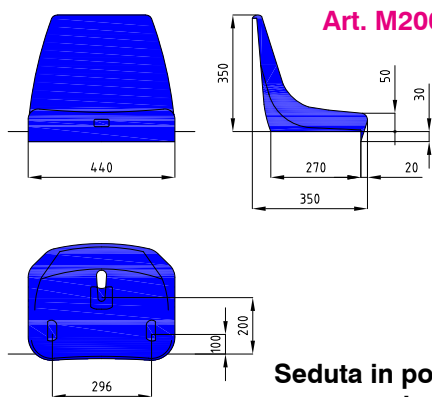

**Art. M2008/M2008A**



**Seduta in polipropilene con schienale ignifuga e antiultravioletti Art. M2008 oppure solo antiultravioletti Art. M2008A - fissaggio diretto sulla gradinata con tasselli (non inclusi)**

Polypropylene Seat non ignitable and anti-ultraviolet rays **Art. M2008** or only anti-ultraviolet rays **Art. M2008A** with back rest to be fixed with screws (not included)

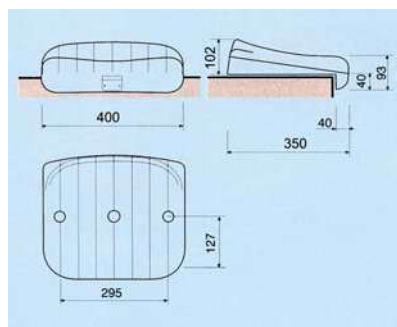
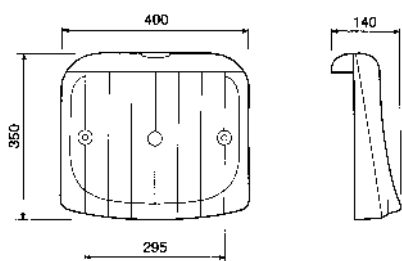

**Art. M90/M90.A**

**Art. M90 Seduta in polipropilene senza schienale ignifuga e antiultravioletti fissaggio diretto sulla gradinata con tasselli (non inclusi)**

Polypropylene Seat non ignitable and anti-ultraviolet rays, without back rest - to be fixed with screws (not included)

**Art. M90.A**

**Seduta in polipropilene senza schienale come Art. M90 solo antiultravioletti fissaggio diretto sulla gradinata con tasselli (non inclusi)**

pg.32

Polypropylene Seat as Art. M90 anti-ultraviolet rays, without back rest - to be fixed with screws (not included)



## TRIBUNE - Stands



### Art. G12005

**Modulo Tribuna per interno/esterno su 3 file in acciaio zincato trasportabile su ruote, piani di seduta in carply, lunghezza m. 2,5**  
Indoor/outdoor Stand in galvanized steel, 3 rows, movable on wheels, with wooden benches



pg.32



### Art. G12006

**Modulo Tribuna per interno/esterno su 3 file in acciaio zincato trasportabile su ruote, piani di seduta con scocche in polipropilene, lunghezza m. 2,5**  
Indoor/outdoor Stand in galvanized steel, 3 rows, movable on wheels, with polypropylene seats





**Art. G120TM**  
**Tribuna telescopica da interno**  
**con sedute in polipropilene**  
Telescopic Stand for indoor  
with polypropylene seats

pg.32



**Art. CTMB1**  
**Cuscino per tribuna pieghevole**  
**rivestito in nylon**  
**colori blu o rosso, bordo nero**  
**(ordine minimo 30 pezzi per colore)**  
Foldable seat Cover - color blue or red  
(minimum quantity 30 pieces per color)



**Art. S07700**  
**Transenna in**  
**acciaio zincato**  
**cm. 200x100h.**  
Galvanized steel barrier 200x100 cm.

pg.32



**Art. S07710**  
**Transenna in plastica cm. 215x90h.** con piedi di appoggio  
**a terra ruotabili, con banda catarifrangente e sistema di**  
**aggancio a catena**  
Plastic barrier 215x90 cm.



## ARREDI PER SPOGLIATOIO - Dressing Room Benches



**Art. S07326 / S07324**  
Tavola appendiabiti  
con grucce m.1 / m.2  
Clothes hanger board m.1 / m.2

**Art. S902.1E / S902.2E**  
Panca in acciaio verniciato  
con listoni in legno m.1 / m.2  
con schienale e appendiabiti  
Bench in painted steel and  
wood length m.1 / m.2  
with back rest and clothes hanger board



**Art. S07308 / S07306**  
Panca in acciaio verniciato  
con listoni in legno  
m.1 / m.2 con schienale  
Bench in painted steel and  
wood length m.1 / m.2  
with back rest

**Art. S07304 / S07302**  
Panca in acciaio verniciato  
con listoni in legno m.1 / m.2  
Bench in painted steel and  
wood length m.1 / m.2

pg.32



**Art. S07406 / S07404**  
Pedana poggiapiedi a listoni  
in legno lunghezza m.1 / m.2  
Footrest in wood, length m.1 / m.2

**Art. S07312 / S07310**  
Panca con schienale, appendiabiti e  
portaborse in acciaio verniciato  
con listoni in legno  
lunghezza m.1 / m.2  
Complete Bench  
in painted steel and  
wood length m.1 / m.2

Disponibile  
anche lunghezza  
m. 1,5  
(al prezzo della  
lunghezza m. 2)  
Also available  
length 1,5 m.  
(at the same price  
as length 2 m.)

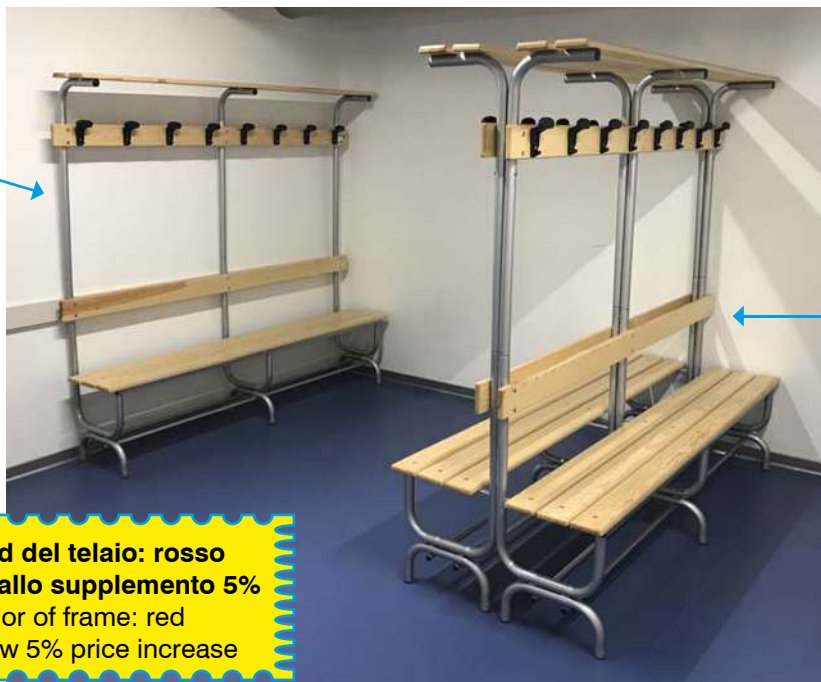

**Art. S07314**  
Panca completa  
ad isola per centro  
locale m.2  
in acciaio verniciato  
con listoni in legno  
Double bench  
in painted steel and  
wood length m.2

Colore standard del telaio: rosso  
Se in argento o giallo supplemento 5%  
Standard color of frame: red  
For silver or yellow 5% price increase





**Art. V8626**

**Profondità  
seduta cm. 35  
altezza massima cm.185**  
Depth 35 cm.  
height 185 cm.

**Art. V8627**

**Art. V9093**

**Panca con schienale, appendiabiti e portaborse in alluminio anodizzato con inserti in PVC lunghezza m. 1 Art. V8626 oppure lunghezza m. 2 Art. V8627**  
Complete Bench in anodized aluminium length m. 1 **Art. V8626** or length m. 2 **Art. V8627**

pg.33

**Pedana poggiapiedi in alluminio anodizzato lunghezza m. 1 Art. V9092 oppure lunghezza m. 2 Art. V9093**  
Footrest in anodized aluminium length 1 or 2 meters

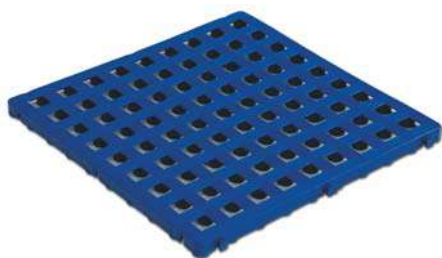

**Art. S07408**  
**Pedana poggiapiedi in plastica cm. 50x50**  
Plastic footrest 50x50 cm.



**Art. S07434**  
**Graticcio per doccia in legno cm. 60x60**  
Wooden footrest 60x60 cm.



**Art. S07466**  
**Asciugacapelli elettrico con temporizzatore e tubo flessibile**  
Hair dryer with timer and flexible pipe

**Art. S07458**  
**Asciugamani elettrico con temporizzatore**  
Hand dryer with timer



**Art. TPD** Poggiapiedi Footsy idrorepellente  
Foldable foot rest waterproof



**ALTRI ARTICOLI SUL LISTINO PREZZI**

pg.33

**Art. S07462**  
**Asciugacapelli elettrico con temporizzatore**  
Hair dryer with timer





## ARMADIETTI PER SPOGLIATOIO Dressing Room Lockers



**Art. S07226**  
Armadio spogliatoio  
a 15 posti in lamiera verniciata  
dimensioni totali  
overall dimensions  
cm. 103Lx35px180h

pg.34



**Art. MAP30**  
Armadio portavalori a 30 sportelli  
dim. cm. 50hx95Lx20p con serrature  
Safe-deposit locker with 30 boxes

**Art. MAP50**  
Armadio portavalori a 50 sportelli  
dim. cm. 82hx95Lx20p con serrature  
Safe-deposit locker with 50 boxes



Armadietti in laminato - HPL panels

**Art. S07252 / S07254 / S07256**  
Armadio spogliatoio in laminato  
dim. vano cm.30Lx50px90h.  
1 colonna 2 vani  
2 colonne 4 vani  
3 colonne 6 vani  
Laminated Lockers

**Art. S07258 / S07260 / S07262**  
Armadio spogliatoio in laminato  
dim. vano cm.30Lx50px180h.  
1 colonna 1 vano  
2 colonne 2 vani  
3 colonne 3 vani  
Laminated Lockers



## ACCESSORI PER SPOGLIATOIO E INFERMERIA Dressing room and infirmary accessories



**Art. S07448**  
Specchio a parete  
con cornice in plastica  
diam.cm.60  
Wall mirror with frame  
diameter 60 cm.

**Art. S07438**  
Distributore di sapone  
liquido a parete  
Wall soap dispenser



**Art. S07442**  
Distributore di salviette a parete  
Wall towel dispenser



ALTRI ARTICOLI SUL  
LISTINO PREZZI



**Art. S07412**  
Tavolo per  
spogliatoio e  
locale arbitri  
cm. 80x80x76  
Locker room  
table  
80x80x76 cm.

pg.33



**Art. S07416** Bacheca  
con struttura in alluminio cm. 120x90  
Bulletin Board 120x90 cm.

**Art. S07414**  
Sedia in acciaio cromato  
scocca in polipropilene  
Chromed steel chair  
with polypropylene seat



**Art. S07418**  
Portaombrelli a 24 posti  
in acciaio verniciato  
Steel umbrella stand



**Art. S07715** Spazzolone  
per pulizia e asciugatura  
area pubblica e campo di gioco  
Scrubber for cleaning playground





**Art. S07102 / S07104**  
**Armadio a vetri a una o due ante**  
Glass Cabinet with one or two doors



**Art. S07106** **Paravento a tre ante**  
**struttura in acciaio cromato**  
Three shutter foldable screen



**Art. S07138**  
**Cassetta medica secondo D.M. 388**  
First aid kit

pg.33

pg.34

**ALTRI ARTICOLI SUL LISTINO PREZZI**



**Art. S07128**  
**Scaletta scendiletto**  
**in acciaio cromato**  
Bedside step



**Art. S07124**  
**Sgabello girevole**  
**in alluminio**  
Turnable stool



**Art. S07108**  
**Appendiabiti a colonna**  
**in acciaio cromato**  
Clothes stand



**Art. S07132**  
**Cestino in plastica**  
Plastic trashcan

**Art. S07130**  
**Portarifiuti**  
**a pedale**  
**in acciaio**  
**verniciato**  
Metal trashcan



**Art. S07134**  
**Barella pieghevole**  
**in acciaio cromato**  
Foldable Stretcher in  
chromed steel



**Art. S07110**  
**Scrivania con cassettera**  
**dim. cm.130x76x78**  
Desk with 3 drawers dimensions 130x76x78 cm.



**Art. S07114**  
**Sedia imbottita, in acciaio cromato** Chair in chromed steel



**Art. S07410**  
**Tavolo per massaggi in acciaio imbottito in similpelle**  
Massage table

pg.34

**Art. PBN**  
**Bilancia pesapersona con statimetro**  
Scales with height measurer



**Art. 3031S**  
**Lettino Antero chiudibile testiera regolabile**  
**cm.180x60x73**  
**peso Kg.20**  
**colore nero**  
**in acciaio cromato**  
Medical couch foldable in chromed steel

**Art. 3033S**  
**Borsone porta lettino Antero**  
Bag for Art. 3031S



**Art. PTI.BIL**  
**Bilancia pesapersona digitale con indicazione massa grassa**  
Digital scales body fat measurer

**Art. S07118**  
**Portarotolo**  
Paper roll holder

**Art. S07120**  
**Rotolo carta**  
Roll of paper



**Art. S07116**  
**Lettino visita medica imbottito con testiera reclinabile**  
Medical couch in chromed steel, padded, adjustable headrest



## TUNNEL USCITA SPOGLIATOI - Stadium tunnels



**Art. 160** Tunnel estensibile struttura in lega d'alluminio, copertura in PVC ignifugo Cl.2 bianca o colorata, montato su ruote in nylon, dimensioni standard (personalizzabili): larghezza cm.200, altezza al centro cm.232, in moduli da un metro

Extensible Tunnel in light alloy covered by fireproof PVC Cl.2, white or coloured, movable on nylon wheels - Standard dimensions 200 cm. width - 232 cm. height in the middle, made of 1 meter segments joined together



**Lunghezza, larghezza  
e altezza  
personalizzabili su richiesta**  
Any dimension available  
on request



## BEACH SOCCER



**Art. PBST Coppia Porte Beach Soccer m. 5,5x2,2 in lega d'alluminio, tubo sezione mm. 80 verniciate in giallo con bussole**  
Pair of Beach Soccer goals in aluminium 5,5x2,2 m. - pipe 80 mm. painted yellow with sockets

pg.26

pg.27

**Art. 110BS Coppia Porte Beach Soccer m. 5,5x2,2 in lega d'alluminio tubo sezione mm. 120x100 verniciate in giallo con bussole (senza innesti da cementare)**  
Pair of Beach Soccer goals in aluminium 5,5x2,2 m. - pipe 120x100 mm. painted yellow with sockets



**Art. 073BS Kit 10 paletti completi per Beach Soccer (6 bandierine rosse e 4 bandierine gialle)**  
Beach Soccer Kit of 10 Poles (6 red flags and 4 yellow flags)

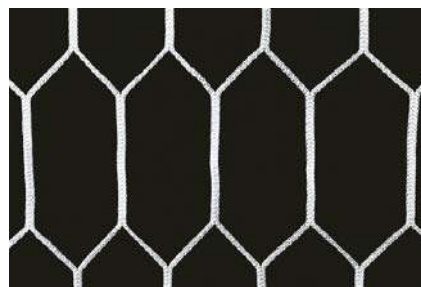

**Art. RBS Coppia reti per porte Beach Soccer m. 5,5x2,2 in polipropilene**  
Pair of polypropylene nets for Beach Soccer goals 5,5x2,2 m.



**Art. KDBS Kit Delimitazione per campo Beach Soccer, colore blu: 2 nastri m. 28 + 2 nastri m. 37 da mm. 80 + 8 picchetti e 8 elastici**  
Kit for Beach Soccer bounds



**Art. ULT45 Pallone Beach Soccer Trial in gomma doppio strato (fino ad esaurimento scorte)**  
Trial Beach Soccer Ball double stratum rubber (until available in stock)



## TAVOLI CALCETTO - Soccer tables



**Art. GA-F1**  
**Tavolo calcetto**  
**in legno modello F1**  
**dim.cm.121x92x78h**  
**aste telescopiche**  
**ideale per bambini**  
 Soccer table model F1  
 very good for children



**Art. JKBOM**  
**Tavolo calcetto Bomber senza gettoniera**  
**aste telescopiche, piano in vetro temperato**  
**colore blu o bianco**  
 Soccer table Bomber



**Art. IS432**  
**Confezione 10 palline per**  
**tavolo calcetto**  
 10 Soccer table balls



**Art. FTGO.G**  
**Tavolo calcetto modello Pride con**  
**gettoniera, aste cromate telescopiche,**  
**gambe in ferro verniciato, mobile in**  
**multistrato, peso kg. 73**  
 Soccer table model Pride with coin slot  
 telescopic, legs in painted steel, weight  
 73 Kg.



**Art. G500**  
**Tavolo calcetto da esterno**  
**G500 Weatherproof**  
**con aste telescopiche**  
 Soccer table G500 for outdoor



**Art. FTEC**  
**Tavolo calcetto modello Pride**  
**con vetro protettivo**  
**ad alta resistenza, peso kg. 85**  
 Model Pride with high resistance safety  
 glass, weight 85 Kg.



## BASKET



**Art. 0873**  
**Impianto basket monotubolare zincato con sbalzo mt. 2,20 completo di tabelloni in resina melaminica, canestri e retine**  
 Basketball monotubular system galvanized with boards for outdoor



**Art. BG2235**  
**Coppia protezioni imbottite per impianto basket monotubolare h. cm. 200**  
 Pair of soft protections for Art. 0873



**Art. V4248**  
**Impianto basket monotubolare trasportabile tabelloni in legno sbalzo cm.165 canestri e retine**  
 Monotubular transportable basketball system

**Art. V4500**  
**Impianto basket come Art. V4248 zincato con tabelloni in resina melaminica**  
 Monotubular transportable galvanized basketball system boards in resin for outdoor



**Art. V4267**  
**Set protezioni con pannello in legno rivestito in PE sp. mm. 20**  
 Pair of soft protections for Art. V4248

pg.34



**Art.0857/0862/0858/0863**  
**Impianto basket a traliccio zincato, sbalzo mt.2,20 fisso o mobile su ruote completo di contenitori in bilaminato o in resina melaminica, canestri e retine**  
 Basketball system in galvanized steel, with wooden or outdoor boards, fixed or transportable models

**Art. B2084**  
**Coppia protezioni imbottite per impianto basket a traliccio dim. cm.200x130**  
 Pair of soft protections for basketball system dimension 200x130 cm.





**Art. S04056 / S04058**  
**Impianto basket a muro fisso con sbalzo cm. 185 oppure cm. 325, tabelloni in bilaminato, canestri e retine**  
Wall basketball system projection 185 or 325 cm. wooden boards, rings and nets



**Art. S04151**  
**Impianto minibasket a muro fisso, sbalzo cm. 80, tabelloni in bilaminato canestri e retine**  
Wall mini-basketball system projection 80 cm.



pg.34

**Art. S04152**  
**Impianto minibasket a muro fisso, sbalzo cm. 185 tabelloni in bilaminato canestri e retine**  
Wall mini-basketball system projection 185 cm.



**Art. S04150**  
**Impianto basket/minibasket a muro regolabile in altezza con canestro e retina**  
Wall basketball/mini-basketball system adjustable height



**Art. 0986**  
**Impianto minibasket fisso a colonna zincato altezza regolabile tabelloni in resina canestri e retine**  
altezza standard cm. 260 (su richiesta cm. 305)  
Mini-basketball system galvanized steel posts, adjustable height, plastic boards, rings and nets standard height 260 cm. (305 cm. on request)

pg.35

**Art. S04161**  
**Coppia strutture minibasket agganciabili a tabelloni basket complete di tabelloni in bilaminato, canestri e retine (attrezzo per sollevamento tabelloni Art. S04162 non incluso)**  
Pair of mini-basketball constructions to be attached to basketball boards (rising tool Art. S04162 not included)



**Art. S04162**





**Art. 0987**  
**Impianto minibasket a colonna regolabile in altezza e trasportabile, fornito con canestri e retine**  
 Transportable mini-basket system

**Altezza massima cm. 260**  
 Maximum height 260 cm.

pg.35

**Art. S04012**  
**Struttura basket e minibasket richiudibile e trasportabile in acciaio verniciato, base porta zavorra, tabellone in resina, canestro fisso e retina, protezione frontale**  
 Transportable and foldable Basket/Minibasket in painted steel, resin board, front protection



**Art. 45097**  
**Micro tabellone con palla (fino ad esaurimento)**  
 Wall micro board with ball (until available)



**Art. 26760**  
**Tabellone minibasket in plastica da fissare al muro, fornito con canestro e retina**  
 Wall minibasket board



**Art. 26759**  
**Basket a colonna regolabile in altezza da cm. 229 a cm. 305 trasportabile, con canestro e retina tabellone cm.120x70 - rinforzato**  
 Basket adjustable height from 229 cm. to 305 cm. transportable



**Art. PPV01**  
**Protezione monotubolare singola in nylon idrorepellente con velcro cm. 180x9x2 per Art. 647B e Art. 26759**  
 Single monotubular soft protection for Art. 647B and Art. 26759



**Art. F126BSK**  
**Set Baskin trasportabile professional**  
 Transportable Baskin

**Art. 647B** Minibasket a colonna regolabile in altezza da cm. 168 a cm. 229 trasportabile, con canestro e retina tabellone cm. 90x60  
 Minibasket adjustable height from 168 cm. to 229 cm. transportable





**Art. F102**  
**Canestro Basket regolamentare**  
 (retina esclusa)  
 Basket standard



**Art. F103**  
**Canestro Basket rinforzato**  
 (retina esclusa)  
 Basket reinforced



**Art. F105**  
**Canestro Basket zincato**  
 (retina esclusa)  
 Basket galvanized



**Art. B030**  
**Coppia Retine in nylon**  
 mm. 3,5  
 Pair of nets 3,5 mm.



**Art. B050**  
**Coppia Retine in nylon**  
 mm. 6  
 Pair of nets 6 mm.



**Art. B060**  
**Coppia Retine in cotone**  
 mm. 7  
 Pair of nets 7 mm.



**Art. R122**  
**Coppia Retine in acciaio**  
 Pair of steel nets



**Art. F106**  
**Canestro Basket reclinabile, a norme FIBA**  
 (retina esclusa)  
 Reclining Basket



**Art. S04236**  
**Canestro Basket reclinabile, omologato a norme FIBA (retina esclusa)**  
 Approved reclining Basket

pg.35

**Art. NRGC**  
**Set 12 ganci reggirete in plastica per canestro basket**  
 Set 12 plastic basket net holders

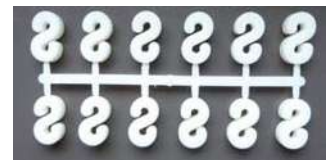

**Art. S04202 - S04214 - S04204 - F116/B - S04216**  
**Coppia tabelloni in bilaminato per interno oppure in resina melaminica per esterno - varie dimensioni**  
 Pair of basketball boards in chipboard for indoor or in resin for outdoor - various sizes

**Brevettato**  
**Patented**

**Art. F109**  
**Canestro Basket reclinabile frontalmente e lateralmente (retina esclusa)**  
 Front/Side reclining Basket

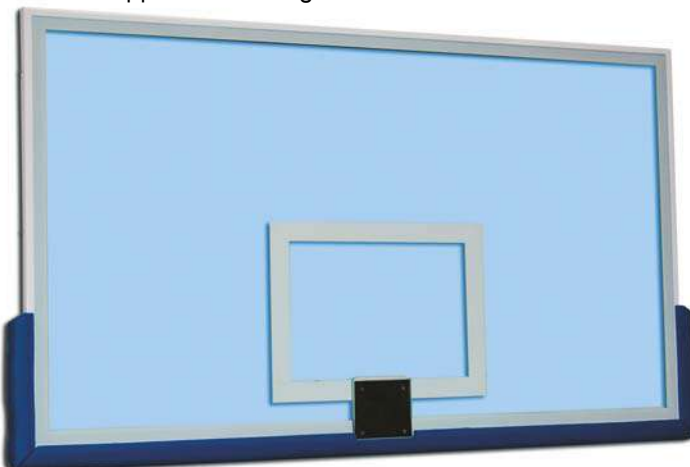

**Art. S04206 / S04208**  
**Coppia tabelloni in Plexiglass trasparente oppure cristallo temperato dimensioni cm. 180 x 105 - compreso telaio e protezione**  
 Pair of basketball boards in transparent acrylic or tempered glass 180 x 105 cm. mounted onto varnished steel frame with pads

**Art. B2063B / B2063**  
**Coppia Protezioni sottocanestro omologate FIBA e non**  
 Pair of soft board protection pads FIBA approved or not

pg.34 pg.35





**Art. S04254**  
Panca per atleti e riserve con poggiaschiena m.3  
Bench length 3 meter with back rest

**Art. S04266**  
Protezione mobile per tavolo giuria e atleti in policarbonato trasparente  
Transparent movable polycarbonate protection for benches and referees' table

pg.35



**Art. ESB100** pg.45  
Elemento di separazione e protezione bordo campo dim. cm. 120x40x100h.  
in gommapiuma D30 rivestita in PVC con fondo antiscivolo e velcro  
Foam rubber bound with PVC cover for floor delimitation size 120x40x100h. cm.



**Art. S04256**  
Tavolo giuria cm. 160x80x76h.  
Referee table



**Art. S04262**  
Tavolo giuria cm. 300x70x76h. carenato su ruote  
Referee table on wheels

pg.36



**Art. S04288**  
Freccia indicatrice possesso palla  
Ball possession arrow



**Art. F255**  
Freccia indicatrice elettronica possesso palla  
Electronic ball possession indicator



**Art. F254**  
Segnalatore time out con impugnatura  
Time out indicator



**Art. CR016**  
Cronometro contasecondi da tavolo a pila con display digitale  
Digital Table Clock for basketball



**Art. CR005**  
Cronometro contasecondi da tavolo a pila con lancette  
Table Clock for basketball





**Art. S04280**  
**Segnapunti**  
**manuale**  
**girevole**  
**a 6 cifre**  
 6 figure  
 Scoreboard

pg.36



**Art. B01084**  
**Segnapunti da tavolo per Basket**  
 Table scoreboard



**Art. S04274**  
**Serie Palette 24"**  
 Set of 24 sec indicators

pg.35



**Art. S04272**  
**Serie palette per giudici**  
 Set of referee's foul indicators



**Art. S04282**  
**Segnapunti manuale a parete a 6 cifre,**  
**struttura in acciaio verniciato**  
 Wall steel 6 figure scoreboard

pg.36

**Art. 089-B**  
**Lavagna Basket**  
**cancellabile cm. 40x23**  
 Basket Tactical Board  
 erasable 40x23 cm.



**Art. 087-B**  
**Lavagna Basket**  
**magnetica**  
**cancellabile**  
**cm. 60x85**  
 Basket Tactical  
 Board erasable  
 and magnetic  
 60x85 cm.



**Art. LSRK**  
**Lavagna Basket magnetica cm. 40x23**  
**con block-notes (fino ad esaurimento)**  
 Basket Tactical Board  
 magnetic 40x23 cm. with block-notes  
 (until available)



**SKLZ** >>



**Art. SK.CVS**  
**COURT VISION**

**Occhiali a visibilità limitata per allenamento al palleggio a testa alta, alla visione di gioco e alla reattività nei confronti dei difensori misura unica regolabile**

Court vision dribble goggles force players to handle the ball with their head up to survey the court improve reaction time against defenders increase confidence on the court

**SKLZ** >>



**Art. SK.KOT**  
**KICK-OUT per ritorno palla dopo tiro a canestro - direzione regolabile**

360° ball return system rotating chute returns made shots anywhere on the court easy twist adjustment with integrated handle



La fascia con le braccia gonfiate deve essere posizionata all'altezza delle spalle, e per installarla può essere necessario sgonfiare moderatamente la sagoma. Successivamente, dopo avere rigonfiato, se la sagoma torna in posizione verticale con difficoltà si deve aggiungere dell'acqua nel serbatoio

**Art. KBVS**  
**Kit braccia verticali per sagoma gonfiabile cm. 205 Art. SAG205**  
Raised arms kit for inflatable dummy 205 cm. Art. SAG205

**Specifico per il Basket, il kit si installa facilmente sulla sagoma (non inclusa) e rende possibile una moltitudine di esercizi tecnico-tattici**  
Designed for Basket training, this kit is easily installed on the dummy (not included) and makes lots of technical and tactical exercises possible

**SKLZ** >>

pg.36



**Art. SK.DMAN**

**Sagoma Basket D-MAN**  
**ad altezza regolabile da cm. 198 a cm. 243**  
**con basamento riempibile,**

**munita di puntali per fissaggio anche su terreni naturali**  
Hands-up defensive mannequin ideal for solo practice or team settings portable, lightweight adjustable telescoping pole (from 198 cm. to 243 cm.)  
Weighted base - including spikes for natural grass anchoring





**Art. MSBK4** Pallone avviamento al Minibasket Mondo gomma nylon misura 4  
Minibasket introduction ball



**Art. SB4Y** Pallone avviamento al Minibasket Molten gomma nylon misura 4  
Minibasket introduction ball



**Art. M13565** Pallone Street Basket Mondo 3x3 misura 6 (ad esaurimento)  
Mondo Street Basket ball 3 vs 3 - size 6



**Art. B3002** Pallone Basket e Minibasket gomma nylon misure 5-7  
Nylon rubber Basket and Minibasket ball



**Art. SBPRO5** Pallone Minibasket Mondo SB-PRO n. 5 gomma multistrato  
Multilayer rubber Minibasket Mondo SB-PRO 5 ball



**Art. B5G1600** Pallone Minibasket Molten B5G1600 gomma nylon (ex BGR5)  
Nylon rubber Minibasket Molten B5G1600 ball

pg.36



**Art. B7G1600/B6G1600** Pallone Basket Molten B7G1600/B6G1600 gomma nylon (ex BGR7/BGR6)  
Nylon rubber Basket Molten B6G1600/B7G1600 ball



**Art. B7G3800/BGM6X** Pallone Basket Molten B7G3800/BGM6X pelle sintetica FIBA Approved  
Leather Basket Molten B7G3800/BGM6X ball

**Art. B7G4000/BGF6X** Pallone Basket Molten B7G4000/BGF6X pelle sintetica ufficiale FIP  
Leather Basket Molten B7G4000/BGF6X ball



**Art. B7G4500/B6G4500** Pallone Basket Molten B7G4500/B6G4500 pelle sintetica ufficiale FIP Lega Serie A (ex BGG7X/BGG6X)  
Leather Basket Molten B7G4500/B6G4500 ball



**Art. TRBB** Pallone reaction ball Trial rimbalzo e traiettorie imprevedibili per Basket  
Trial Reaction Ball unpredictable rebounds



**Art. BYCB** Pallone Basket bicolore gomma Trial Ø cm. 24 gr. 620  
Trial bicoloured rubber Basket ball



**Art. ULTS67** Pallone Basket gomma Trial allenamento potenziato Ø cm. 24 gr. 930 (+50%)  
Rubber Trial Heavier Basket ball



**Art. ULTD67** Pallone Basket gomma Trial allenamento potenziato Ø cm. 24 gr. 1240 (+100%)  
Rubber Trial Heavier Basket ball



## PALLAVOLO - Volleyball

Art. 6746T



**Art. 6746T**  
**Impianto pallavolo**  
**monotubolare**  
**in acciaio zincato**  
**Ø 76 mm.**  
**completo di bussole**  
**da interrare cm. 40**  
**e tendirete,**  
**altezza della**  
**rete regolabile**  
 Volleyball posts in  
 galvanized steel with  
 underground sockets  
 adjustable height net

pg.38



Art. V5009

**Art. V5009**  
**Impianto**  
**pallavolo**  
**monotubolare**  
**in alluminio T6**  
**antiflessione**  
**mm. 120x100**  
**con arganello**  
**tendirete**  
**autofrenante**  
**e senza**  
**cremagliera**  
**con manovella**  
**asportabile**  
**bussole**  
**e tappi**  
**in alluminio**  
 Aluminium  
 monotubular  
 volleyball posts



**Art. ARGC**  
**Arganello a**  
**cremagliera**  
**con maniglia**  
**per impianto**  
**pallavolo**  
**monotubolare**  
 Spare rack  
 winch for  
 monotubular  
 volleyball  
 posts



Lato interno  
 Inner side

**Art. V5003**  
**Impianto pallavolo**  
**monotubolare**  
**in acciaio zincato**  
**Ø 70 mm.**  
**completo di bussole**  
**da interrare**  
**e tendirete,**  
**con sistema**  
**telescopico**  
**per la regolazione**  
**della rete con doppia**  
**carrucola sulla**  
**sommità del palo**  
 Volleyball posts in  
 galvanized steel with  
 underground sockets  
 telescopic posts  
 adjustable height net

**Art. 6747/P**  
**Impianto pallavolo**  
**monotubolare a**  
**norme FIPAV**  
**in alluminio**  
**sezione**  
**mm. 120x100**  
**regolazione**  
**dell'altezza**  
**dei pali e della rete**  
**con sistema**  
**periscopico**  
**con arganello**  
**tendirete**  
**e bussole incluse**  
 Aluminium  
 monotubular  
 volleyball posts  
 periscopic system  
 FIPAV approved



Art. 6747/P

**La regolazione**  
**periscopica permette**  
**di variare l'altezza**  
**dei pali oltre a quella**  
**della rete (che può**  
**essere regolabile da**  
**cm. 200 a cm. 250)**

**Art. MB2083 Coppia**  
**Protezioni in gommapiuma**  
**rivestita per**  
**impianto monotubolare**  
 Pair of soft protections  
 for volleyball posts

**IMPIANTO**  
**= coppia pali**  
**(rete esclusa)**





**Art. 1009**  
**Impianto pallavolo a traliccio in alluminio ø mm. 120x100 completo di ruote e tendirete**  
 Volleyball posts in aluminium transportable with wheels, pipe section 120x100 mm.

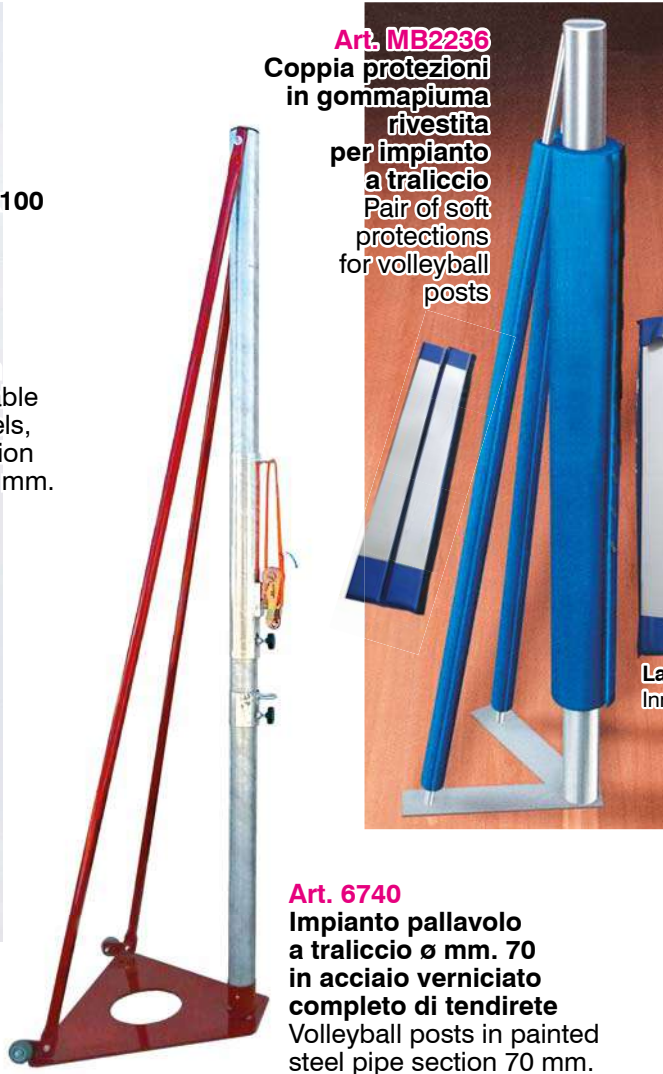

**Art. MB2236**  
**Coppia protezioni in gommapiuma rivestita per impianto a traliccio**  
 Pair of soft protections for volleyball posts

**Lato interno**  
 Inner side

**Art. 6740**  
**Impianto pallavolo a traliccio ø mm. 70 in acciaio verniciato completo di tendirete**  
 Volleyball posts in painted steel pipe section 70 mm.



**Art. V5020**  
**Impianto pallavolo a traliccio ø mm. 70 in acciaio zincato completo di ruote e tendirete**  
 Volleyball posts in galvanized steel, transportable with wheels pipe section 70 mm.



**Art. 6752/P**  
**Coppia protezioni per impianto Pallavolo a parete**  
 Pair of soft protections for volleyball posts for wall fixing

**Art. 6752/T**  
**Impianto Pallavolo a parete**  
 Volleyball posts for wall fixing

pg.38

**IMPIANTO = coppia pali (rete esclusa)**

**Art. V5029**  
**Impianto pallavolo a tiranti ridotti in lega di alluminio profilo sezione mm. 120x100 con ruote per il trasporto piastra antitorsione alla base, arganello tendirete autofrenante senza cremagliera antinfortunistico**  
 Volleyball posts in aluminium transportable with wheels, pipe section 120x100 mm.







**Art. E6532**

**Rete pallavolo economica m. 9,85**  
Cheap net for volleyball

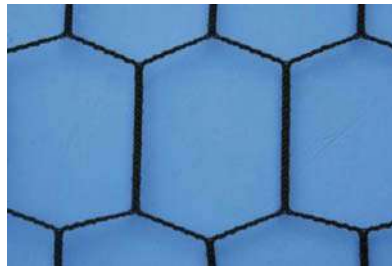

**Art. P030**

**Rete pallavolo m. 9,50**  
Net for volleyball

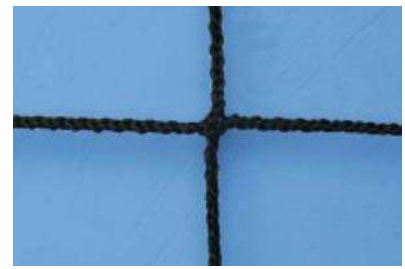

**Art. P100**

**Rete pallavolo super pesante m. 9,50**  
maglia mm. 100  
Heavy net for volleyball

pg.38



**Art. P110**

**Rete pallavolo extra pesante**  
maglia mm. 100  
m. 9,50 a doppia fascia  
Heavy net for volleyball double band

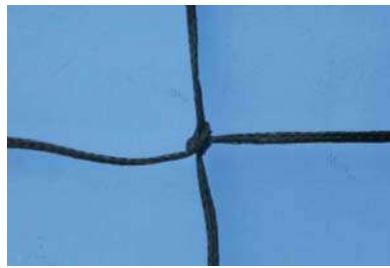

**Art. P200**

**Rete pallavolo da gara**  
maglia mm. 100  
con antenne e tasche  
a norma FIPAV  
Official net for volleyball  
with sticks and fixing bands



**Art. P201**

**Rete pallavolo da gara**  
maglia mm. 45  
a norma FIPAV  
(personalizzabile)  
Official net for volleyball  
(customizable)

pg.39



**Art. P14**

**Coppia antenne in vetroresina divise**  
Fiberglass sticks in 2 pieces

**Art. P15**

**Coppia bande verticali cm. 5**  
Fixing bands  
for sticks

**Art. P16**

**Coppia antenne in vetroresina intere**  
One piece fiberglass  
sticks



**Art. S04814**  
**Segnapunti manuale girevole a 4 cifre**  
4 figure  
scoreboard



**Art. PP054**

**Segnapunti manuale da tavolo per Pallavolo bifacciale**  
(numeri da 0 a 50 non divisi)  
Volleyball table scoreboard



**Art. PPP30**

**Segnapunti scolastico per Pallavolo**  
numeri da 0 a 30 rinforzati  
Volleyball school scoreboard





**Art. 6768R**  
**Seggiolone arbitro pallavolo in piedi, in acciaio verniciato, mobile su ruote**  
Referee's stand made of painted steel, on wheels

pg.39



**Art. S04804**  
**Seggiolone arbitro pallavolo ad altezza fissa con scocca di seduta, in acciaio verniciato, mobile su ruote**  
Referee's stand fixed height with plastic seat, made of painted steel, on wheels



**Art. 1020**  
**Seggiolone arbitro pallavolo approvato FIPAV regolabile in altezza con scaletta di accesso e ruote per trasporto**  
FIPAV Referee's chair



**Art. S04816**  
**Serie 18 Palette per sostituzione giocatori con contenitore**  
Set of 18 substitution indicators

**Art. 089-V**  
**Lavagna per Pallavolo cancellabile cm. 35x25**  
Volleyball Tactical Board erasable 35x25 cm.







**Art. V5081**  
**Simulatore di muro su ruote in acciaio, zavorrato, con pannello a superficie irregolare**  
 Portable wall in painted steel with irregular surface board



**Art. V5082**  
**Simulatore di muro portatile per squadre femminili e giovanili**  
 Portable wall for women and kids

pg.39



**Art. P11032**  
**Misuratore di elevazione da fissare a muro (misura l'elevazione da 1 a 3,40 metri)**  
 Wall jump meter in plastic (up to 340 cm.)

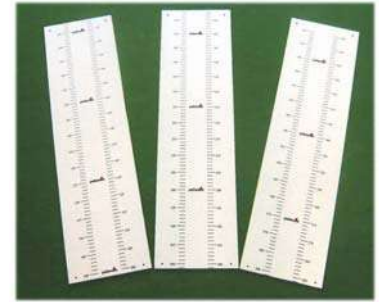

**Art. V5051** **Jump Tester in acciaio zincato telescopico regolabile da cm. 230 a cm. 380 (basamento non incluso)**  
 Jump Tester in galvanized steel telescopic adjustable height from 230 to 380 cm. (base not included)



**Art. V5070**  
**Ball Catcher cm. 70x70 altezza regolabile da cm. 190 a cm. 320 con anello superiore inclinabile, basamento e retone inclusi**  
 Ball catcher, adjustable height and inclination (base and net included)

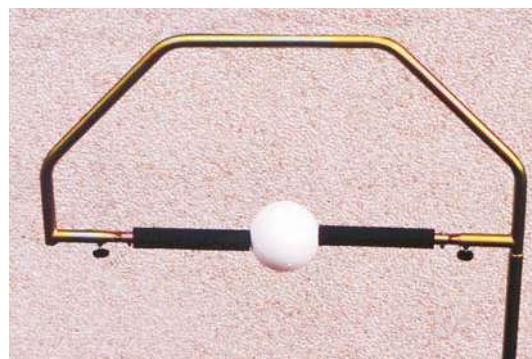

**Art. V5060** **Spike con ganasce (basamento non incluso)**  
 (base not included)

**Art. V5050**  
**Basamento zavorrato multiuso per Ball Catcher, Spike, Jump Tester**  
 Multi-purpose weighted base







Utilizzabile anche per Hit Ball

**Art. BV20**

**Pallone Volley Trial in gomma supersoft**  
Supersoft Trial Volley ball (also for Hit Ball)

 pg.39



**Art. V20**

**Pallone Volley Trial in gomma monostrato**  
Single stratum Trial Volley ball



**Art. ULT20-3**

**Pallone Volley Trial in gomma triplo strato**  
Triple stratum Trial Volley ball

**Art. MVBS**

**Pallone Volley School Mondo Under 13 peso ridotto**  
Under 13 Mondo Volley School ball

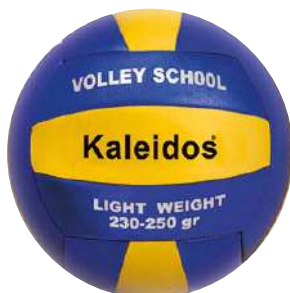

**Art. E6835**

**Pallone Volley Soft Touch in PU saldato, regolamentare**  
Official size and weight Volley ball



**Art. 18335**

**Pallone Volley School Molten V5M2501-L Under 13 peso ridotto**  
Under 13 Molten Volley School ball



**Art. 29096**

**Pallone Volley Molten Ultra Touch V5M1500 allenamento**  
Molten Volley training ball



**Art. 6036**

**Pallone Volley Molten V5M4000**  
Molten Volley ball



**Art. 6331**

**Pallone Volley gara Molten V5M5000 "FLISTATEC" FIVB Approved**  
Molten Volley match ball

**Art. BYCV**

**Pallone Volley Trial gomma bicolore**  
Trial bicoloured rubber Volley ball



**Art. TRBV**

**Pallone Reaction Ball Trial doppio strato per Volley rimbalzo e traiettorie imprevedibili**  
Trial Volley ball for unpredictable rebounds



**Art. USE20**

**Pallone Volley Trial gr. 405 (+50%) ø cm. 21 per allenamento potenziato**  
Rubber Trial heavier Volley ball

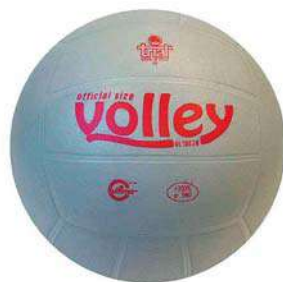

**Art. ULTD20**

**Pallone Volley Trial gr. 540 (+100%) ø cm. 21 per allenamento potenziato**  
Rubber Trial heavier Volley ball

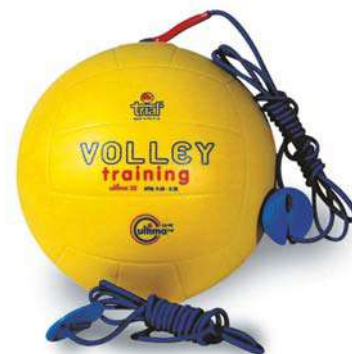

**Art. ULT22**

**Pallone Volley Trial training con 2 elastici**  
Trial training Volley ball with 2 elastic ropes







## IMPIANTI MULTIFUNZIONE Multi-purpose systems



### Art. S05206

**Impianto multifunzione professionale per volley, minivolley, tennis e salto in alto - basi zavorrate in acciaio zincato su ruote gommate, ritti centimetrati in alluminio verniciato con cursore scorrevole**  
 Volley, Minivolley, Tennis and High Jump transportable system - galvanized weighted bases with wheels, posts in painted aluminium with slider



### Art. S05210

**Rete per impianti multifunzione**  
 Art. S05202/S05204/S05206/PA020  
**dimensioni m. 9x1**  
 Net for multi-purpose systems size m. 9x1

**Art. 6780M**  
**Impianto volley e minivolley trasportabile zavorrato**  
 Weighted Volley and Minivolley transportable system

● pg.38



### Art. S05208

**Coppia tabelloni in plastica con canestro su supporto in acciaio per Art. S05206**  
 Pair of Basket Boards with baskets and steel back frames for Art. S05206



### Art. S05209

**Set protezioni per impianto multifunzione**  
 Art. S05206  
 Soft Protection set for transportable system Art. S05206

● pg.43



### Art. S05202

**Impianto multifunzione volley, minivolley, badminton, tennis trasportabile zavorrato strutture verticali in acciaio zincato e verniciato, con ruote**  
 Volley, Minivolley, Badminton and Tennis transportable system

### Art. S05204

**Impianto multifunzione come Art. S05202 ma valido anche per basket (con tabelloni in plastica)**  
 Same of Art. S05202 but also for basket (with plastic boards)



**Art. PA020**  
**Impianto multifunzione trasportabile completo di protezioni**

Volley, Minivolley, Badminton and Beach Tennis transportable system

**Altezza rete (non inclusa) regolabile da cm. 91 a cm. 245**  
**Basi in ABS con ruote, riempibili con sabbia**



## BEACH VOLLEY

**Art. 1051** Impianto Beach Volley regolamentare in alluminio Ø mm.80 (rete esclusa) altezza rete regolabile anche per Beach Tennis  
Beach volley posts in aluminium (net not included) adjustable height net also for Beach Tennis

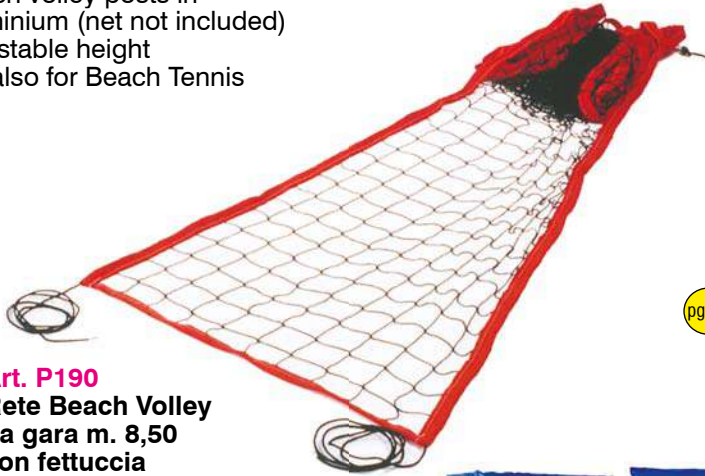

pg.40

**Art. P190** Rete Beach Volley da gara m. 8,50 con fettuccia su tutto il perimetro  
Beach volley match net

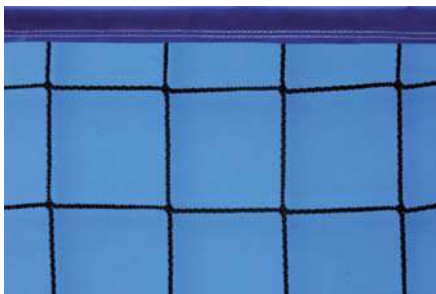

**Art. P170** Rete Beach Volley m. 8,50 con fettuccia sul lato superiore  
Beach volley net



Lato A Lato B

**Art. V5513** Impianto Beach Volley in alluminio (rete esclusa) senza bussole altezza rete regolabile anche per Beach Tennis  
Beach Volley posts in aluminium (net not included) with no sockets adjustable height net also for Beach Tennis



**Art. BVMBP** Coppia protezioni per impianto Beach Volley regolamentare altezza cm. 200 diametro cm. 8  
Pair of Beach Volley posts soft protections

**Art. V5510** Impianto Beach Volley in acciaio zincato (rete esclusa) altezza rete regolabile anche per Beach Tennis  
Beach Volley posts in galvanized steel (net not included) adjustable height net also for Beach Tennis

**Art. F501** Impianto Mini Beach Volley portatile con pali telescopici in ferro verniciato completo di rete mt. 6,5x1 e sacca  
Mini Beach Volley complete set







**Art. V5543**

**Seggiolone per arbitro Beach Volley in acciaio ovale verniciato a polveri sez. mm.60 antinfortunistico e richiudibile in soli 45 cm.**  
Beach Volley referee's Stand

**Art. V5428**

**Set imbottiture per seggiolone Art. V5543**  
Set of Soft Protections for Art. V5543

pg.40



**Art. P17**

**Kit Delimitazione campo Beach Volley (2 nastri m.16 + 2 nastri m. 8 + 8 picchetti + 8 elastici) nastri da mm. 50 occhiellati alle estremità**  
Set for Beach Volley Bounds

pg.41

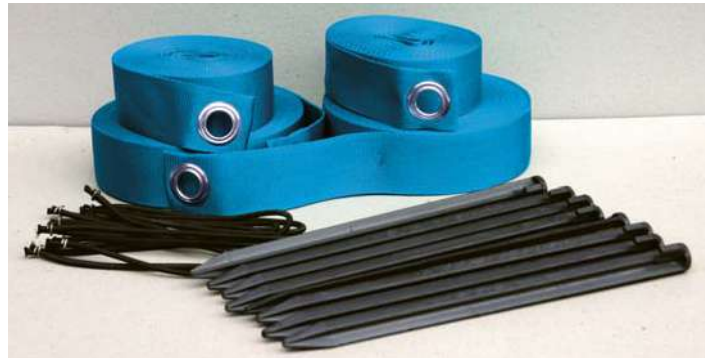

**Art. P19 Kit Delimitazione regolabile per campo Beach Volley e Beach Tennis (2 nastri m.16 + 2 nastri m.8 oppure 2 nastri m.18 + 2 nastri m.9) colore blu**  
Set for Beach Volley and Beach Tennis bounds adjustable blue color



**Art. M13719**

**Pallone Beach Volley Mondo BV 2000 in pelle sintetica**

pg.40



**Art. 6340**

**Pallone Beach Volley da gara Molten V5B5000**  
Pallone ufficiale FIVB

**New!**



**Art. 29097**

**Pallone Beach Volley Molten "Sweet Touch"**



## PROTEZIONI - Protections



pg.39

**Art. E6644**

**Paio ginocchiere Volley trapuntate misura S, M, L  
colori royal, navy, nero, rosso, fucsia, giallo fluo, verde fluo**  
Pair of knee protections size S, M, L



**Art. E6645**

**Paio ginocchiere Volley senza foro  
posteriore con imbottitura modellata  
JR e SR colori royal o nero**  
Pair of knee protections for match size JR and SR



**\*Art. 9293**  
**Paradenti singolo  
taglia adulto**  
Adult Mouthguard

**\*Art. 9293.B**  
**Paradenti singolo  
taglia bambino**  
Junior Mouthguard

**\*Disponibili  
anche senza  
reggi-paradenti**



**Art. 43602A**  
**Paradenti doppio  
taglia S-L**  
Double Mouthguard Size S-L

pg.40



**Art. E6641**

**Paio ginocchiere Volley  
regolabili con velcro, misura SR colori blu e nero**  
Pair of pro knee protections size SR adjustable with  
velcro - colors black and blue



**Art. PDFOX**  
**Paradenti Fox singolo  
taglia adulto - vari colori**  
Adult Fox mouthguard - various colors



**Art. E6633 Paio gomitiere Volley, misura JR e SR  
colori royal, rosso e nero**  
Pair of elbow protections size JR and SR



**New!**

**Art. ESPN**  
**Maschera di  
protezione per  
naso, zigomi  
e arcata  
sopraciliare**  
Face Protection  
Mask



**Art. 73001**  
**Sospensorio  
con conchiglia,  
misura S, M, L**  
Shell Protection  
size S, M, L





Art. E6649

Art. E6650

Art. E6670

**Art. E6649**  
**Paio ginocchiere elasticizzate misura S-M-L-XL**  
Pair of elastic Knee Protections size S-M-L-XL

**Art. E6650**  
**Paio cosciere elasticizzate misura S-M-L-XL**  
Pair of elastic Thigh Protections size S-M-L-XL

**Art. E6670**  
**Paio cavigliere elasticizzate misura S-M-L-XL**  
Pair of elastic Ankle Protections size S-M-L-XL

**New!**



**Art. E784**  
**Ginocchiera in neoprene traspirante taglia S-M-L**  
Neoprene Knee Protection



**Art. IS799**  
**Ginocchiera con supporti rigidi**  
taglia S/M - L/XL  
Knee protection with metal support



**Art. E798**  
**Supporto Coscia in neoprene**  
taglia S-M-L-XL  
Neoprene Thigh Protection



**Art. E786**  
**Cavigliera in neoprene**  
taglia S-M-L-XL  
Neoprene Ankle Protection

pg.40



**Art. 90252A**  
**Fascia sottorotulea in neoprene**  
Neoprene underknee band



**Art. 2651A**  
**Short in neoprene**  
vita alta colore nero  
taglia S-M-L-XL  
Neoprene Shorts



**Art. E796**  
**Supporto gomito in neoprene**  
taglia unica regolabile  
Neoprene Elbow Protection  
one size fits all

**Art. AHF-079**  
**Panciera in neoprene**  
taglia unica 120x25x0,4 cm  
Neoprene stomach band  
25 cm. height





## PALLAMANO - Handball



**Art. 1096**  
Coppia porte pallamano  
in alluminio, reti escluse  
Pair aluminium handball Goals

Le reti per porte pallamano  
corrispondono alle reti  
per porte calcetto m. 3x2  
Same nets as futsal goals m. 3x2



**Art. SH1**  
Pallone Pallamano Trial Micro/Midi  
Handball per l'apprendimento  
dei fondamentali  
Trial Rubber Micro/Midi Handball  
helps in learning the basics



**Art. PTI.HB**  
Lavagna Pallamano  
bifacciale cancellabile  
cm. 35x22  
Handball tactical board



**Art. BA25 / BA0 / BA29 / BA30**  
Pallone Pallamano  
Trial in gomma supersoft  
junior / femminile  
Handball supersoft  
junior / size 2 in rubber



**Art. M13651 / M13650**  
Pallone Pallamano  
Mondo Golden  
pelle sintetica  
mis. 2 e mis. 3  
Handball size 2 and 3  
in synthetic leather



**Art. V29 / V30 / V49 / ULT49-3 / ULT30-3**  
**ULT303.15 / ULT29-3 / ULT24-3**  
Pallone Pallamano in gomma  
Trial (mono e triplo strato) mis. 0-1-1,5-2-3  
Trial Handball in rubber (single and triple stratum)  
size 0-1-1,5-2-3



pg.41



**Art. ULT34 / ULT35 / ULT36-3 / ULT37-3**  
Pallone Beach Handball in gomma Trial triplo strato  
mis. 00, 0, 2, 3  
Trial Beach Handball in rubber size 00, 0, 2, 3



**Art. ULTS29 / ULTD29**  
**ULTS30 / ULTD30**  
**ULTS49 / ULTD49**

Pallone Pallamano  
gomma Trial  
potenziato  
Ø 15/17/18,5 cm.  
gr. 375/500/550/630/  
700/750 (+50% / +100%)  
Rubber Trial Heavier Handball



**Art. TRBH**  
Pallone Reaction Ball Trial  
doppio strato  
rimbalzo e traiettorie imprevedibili  
Trial Reaction Ball unpredictable  
rebounds - for Handball



**Art. BYCH**  
Pallone Pallamano  
bicolore gomma Trial  
Ø cm. 18,5 gr.420  
Trial bicoloured  
Handball



## TABELLONI ELETTRONICI BASKET, PALLAVOLO, MULTISPORT Electronic scoreboards for basketball, volleyball, multisport



### Art. F160

pg.36

Tabellone portatile MULTISPORT da tavolo con tastiera di comando per BASKET, VOLLEY, CALCETTO, PALLANUOTO, PALLAMANO, KICK BOXING, PING PONG ed altro punteggi da 0 a 199 per lato set/bonus/falli da 0 a 9 per lato cronometro massimo 99 minuti e 59 secondi periodi da 0 a 9 - altezza cifre cm.9 dim. cm. 55x35x9,5  
Multisport Table Scoreboard (for BASKET, VOLLEY, FUTSAL, WATER POLO, HANDBALL, KICK BOXING, TABLE TENNIS)



### Art. F345

Tabellone elettronico PLAY30-V con console solo tasti e m. 30 di cavo - dim. cm. 85x38x11 h. cifre cm. 17,4 - indicato per VOLLEY, PING PONG, BADMINTON, SQUASH punteggi 0-199 per lato - set/bonus da 0 a 9 per lato - possesso/priorità/turno lato dx o sx Electronic Board with console, dim. 85x38x11 cm. 17,4 cm. high figures

### Art. F345D

Tabellone elettronico PLAY30-V con console dotata di display  
Art. F345 with display console



### Art. F351D

pg.37

Tabellone MULTISPORT PLAY30-C con console a display luminoso per BASKET, VOLLEY, CALCETTO, PALLAMANO ed altro punteggi da 0 a 199 per lato - set/bonus/falli da 0 a 9 per lato - cronometro 99 minuti e 59 secondi altezza cifre punteggio cm.17,4 - altezza cifre cronometro cm.15 - segnalazione acustica di fine tempo dim. cm.75x59x10 - Peso Kg.12,4 cavo console 60 metri  
Multisport scoreboard PLAY30-C dim. 75x59x10 cm.



### Art. F300-14

Cronometro da esterno (minuti + secondi)  
dim. cm.166,5x59x15 - h. cifre cm. 45 con console  
Timer for outdoor with console



### Art. F331T

Cronometro da interno (minuti + secondi)  
dim. cm.85x38x11 con telecomando a infrarossi  
Timer for indoor with remote control





**Art. F3045015**

Tabellone MULTISPORT dimensioni cm.91x60x9,5 peso Kg.10 - utilizzabile per BASKET, VOLLEY, CALCETTO, PALLAMANO, PALLANUOTO, TENNIS, PING PONG, BADMINTON altezza cifre cm.15 - visualizzazione di punteggi, cronometro, timeout, falli squadra, periodo, possesso palla.

Console Art. F307-01 o Art. F308-01 non inclusa

Electronic Board, dim. 91x60x9,5 cm.

15 cm. high figures for various sport.

Console Art. F307-01 or Art. F308-01 not included



**Art. F307-01**

Console 300 per Art. F3045015

Display LCD - utilizzabile per collegamento via cavo

dim. cm.28,5x10,5x8

Console for Art. F3045015 with cable system



**Art. F308-01**

Console 700 per Art. F242,

Art. F3045025 e Art. F3045015

Display touchscreen - utilizzabile per collegamento sia via cavo che via radio

dim. cm.24,5x17x8,5

Console for Art. F242, Art. F3045025 and Art. F3045015 with cable or radio system

pg.37



**Art. F3045025**

Tabellone segnapunti MULTISPORT

Omologato FIBA livello 3

(BASKET, VOLLEY, CALCETTO, TENNIS, PING PONG, PALLAMANO, PALLANUOTO, BADMINTON)

altezza cifre cm.25 distanza di leggibilità m.110

peso Kg.22 - dimensioni cm.140x83x9

da utilizzare con console Art. F308-01 (non inclusa)

Electronic Board, dim. 140x83x9 cm.

25 cm. high figures for various sport.

Console Art. F308-01 not included

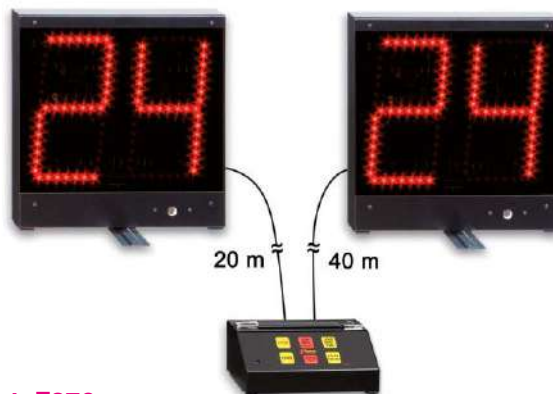

**Art. F270**

Kit indicatori elettronici 24 secondi

h. cifre cm.20 - dim. cm.29,2x30,4x4,4 cadauno

completo di centralina munita di tastiera visualizzazione del tempo di tiro e del timeout

segnalatore acustico di fine tempo, un cavo m.20 e un cavo m.40 in dotazione

Kit 24 second indicators with console



**Art. F268-02**

Kit indicatori elettronici 24-30 secondi wireless

h. cifre cm.20 - dim. cm.28,5x32x10 cadauno

completo di console Art. F308-01

visualizzazione del tempo di tiro

segnalatore acustico di fine tempo

Kit 24 second indicators wireless with console Art. F308-01





pg.37

**Art. F308-01**

Console 700 per Art. F242, Art. F3045025 e Art. F3045015  
 Display touchscreen - utilizzabile per collegamento sia via cavo che via radio  
 dim. cm.24,5x17x8,5  
 Console for Art. F242, Art. F3045025 and Art. F3045015 with cable or radio system

**Art. F242**

**Tabellone MULTISPORT FS-130**  
 dimensioni cm.200x180x9 - peso Kg.60  
 costruito secondo le disposizioni FIBA  
 utilizzabile per BASKET, VOLLEY, CALCETTO, PALLAMANO, HOCKEY, TENNIS, PALLANUOTO  
 altezza cifre cm.30 tempo di gioco 99:59  
 punteggi di squadra (da 0 a 199) - periodo (0 - 9)  
 falli di squadra/set vinti (da 0 a 9) - bonus (1 punto luminoso per squadra)  
 timeout (3 punti luminosi per squadra)  
 possesso/servizio/turno: frecce indicatrici  
 indicazione ultimo fallo avvenuto (numero di maglia del giocatore e numero del fallo)  
 Console Art. F308-01 non inclusa  
 Electronic Board, dim. 200x180x9 cm.  
 30 cm. high figures for various sport  
 Console Art. F308-01 not included

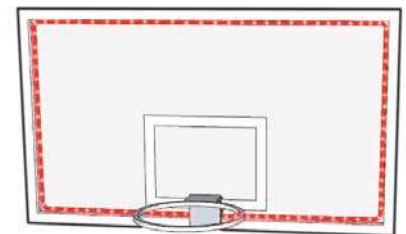

**Art. F253-21**  
 Kit cornice luminosa e centralina di comando per tabellone basket  
 Ledstrip cm.515  
 Kit light frame and control unit for basketball board  
 Ledstrip 515 cm.



pg.37

**Art. F258-51**

**Tabellone elettronico indicatore dei 24 secondi e tempo di gioco FS-24s-1**  
 dim. cm.70,5x60x11,5 h. cifre cm.14 e cm.30 - da collegare con Art. F253-21, completo di cavo m.50 per collegamento alla console Art. F308-01 - protetto contro gli urti della palla - N.B. Per un impianto Basket completo occorrono n. 2 Art. F253-21 + n. 2 Art. F258-51  
 24 second indicator board



**Art. F265-20**

Ricevitore radio per collegamento del tabellone indicatore 24 secondi  
 Art. F258-51 alla console Art. F308-01  
 N.B. Per un impianto Basket completo occorrono n. 2 Art. F253-21 + n. 2 Art. F258-51 + n. 2 Art. F265-20  
 Radio receiver connecting Art. F258-51 to Art. F308-01

pg.38



**Art. F300-26**

**Tabellone elettronico da esterno**  
 ideale per CALCIO, CALCIO RIDOTTO E CALCETTO  
 dim. cm.166,5x118x15 - altezza cifre 45cm.  
 Punteggio squadre da 0 a 9 - Cronometro 99:59  
 orologio - resistente agli urti della palla,  
 da utilizzare con console Art. F308-01 (non inclusa)  
 Electronic scoreboard for outdoor - ideal for Soccer, Futsal - resistant to ball hits  
 (console Art. F308-01 not included)





**TENNIS**

**Art. 8820G**  
Coppia Pali Tennis in acciaio zincato e verniciato a sezione quadra con bussole da interrare e tendirete  
Tennis Posts in painted steel with underground sockets

**Art. 1058**  
Coppia Pali Tennis da fissare al pavimento in acciaio verniciato a sezione quadra e tendirete in bronzo ad arganello  
Tennis Posts in painted steel for ground fixing

**Art. 1059**  
Coppia Pali Tennis da fissare al pavimento in alluminio e tendirete in bronzo ad arganello  
Tennis Posts in aluminium for ground fixing

**Art. 1056**  
Coppia Pali Tennis in acciaio zincato e verniciato a sezione quadra da interrare e tendirete in bronzo ad arganello  
Tennis Posts in galvanized and painted steel with underground sockets

pg.41 pg.42



**Art. 8819G**  
Coppia Pali Tennis in alluminio con bussole da interrare e tendirete  
Tennis Posts in aluminium with underground sockets

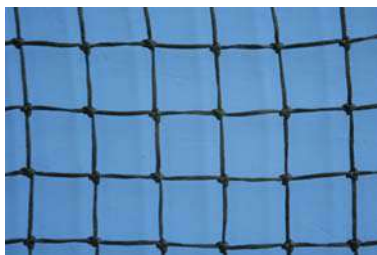

**Art. T030**  
Rete Tennis annodata m.12,80 x 1 - sp. mm. 2,5 (centro rete non incluso)  
Tennis knotted net (Art. RT1 not included)



**Art. T040**  
Rete Tennis da gara annodata modello Wimbledon m.12,80 x 1 - sp. mm. 3,5 (centro rete Art. RT1 non incluso)  
Tennis knotted match net (Art. RT1 not included)

**Art. RT1**  
Centro rete  
Net central holder

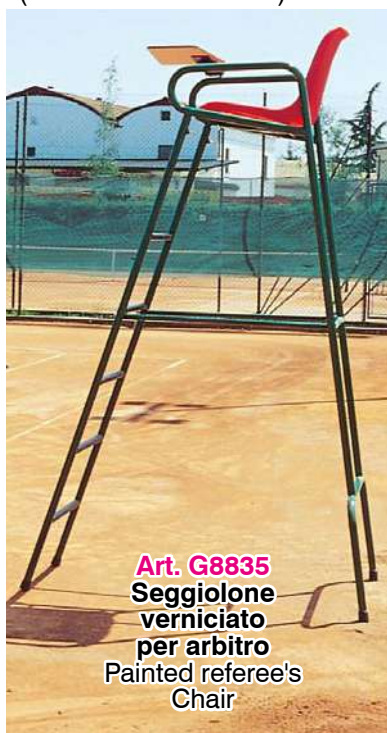

**Art. G8835**  
Seggiolone verniciato per arbitro  
Painted referee's Chair



**Art. TE10031**  
Rete per impianto Art. TE10030  
Net for Art. TE10030

**Art. TE10030**  
Impianto Junior Tennis cm. 500x100 in acciaio trasportabile (rete esclusa)  
Transportable junior Tennis posts in steel (net not included)



**Art. S04862**  
Impianto Tennis in acciaio zincato trasportabile (rete e zavorra escluse)  
Transportable Tennis posts in galvanized steel (net and weights not included)



**Art. S04868**  
Coppia paletti per singolo in acciaio verniciato  
Pair of steel poles for single





**Art. RTAD / RTB912 / RTB58**  
**Racchetta Tennis Dunlop in lega**  
 27" (adulti) - 25" (9/12 anni) - 23" (5/8 anni)  
 Tennis rackets



**Art. 44.045**  
**Over Grip**

**Art. E6620**  
**Paio Polsini**  
**tergisudore**  
 altezza cm. 7  
 Pair of  
 Wrist bands



**Art. E6610**  
**Fascia tergisudore**  
 altezza cm. 5  
 Headband

pg.42



**Art. AGDP**  
**Tubo 3 palle Tennis**  
**depressurizzate Dunlop**  
 Set 3 depressurized  
 Tennis balls



**Art. T4D**  
**Tubo 4 Palle Tennis**  
**Head Championship**  
 Set 4 Tennis Balls

**Art. 07861**  
**Set 3 palline**  
**gommapiuma**  
 Set 3 foam rubber  
 Tennis balls



## BEACH TENNIS



**Art. 48018**  
**Racchetta Beach Tennis in resina**  
 (il colore e la grafica possono variare)  
 Beach Tennis racket

pg.42



**Art. PT41**  
**Pallina Beach Tennis**  
 Beach Tennis ball



**Art. T043**  
**Rete PADEL m.10x0,92**  
 Padel net

**Art. P210**  
**Rete Beach Tennis**  
**con fettuccia su tutto**  
**il perimetro**  
 Beach Tennis net





**Art. TE220.40**  
**Macchina lancia palline**  
 velocità max 130 km/h  
 velocità min 30 km/h  
 frequenza lancio  
 da 2 a 15 secondi  
 Ball throwing machine



**Art. TE51.04**  
**Rullo in acciaio con racla**  
 Levelling roller



pg.42

**Art. RT3**  
**Rotolo m. 150**  
**strisce segnacampo**  
**Tennis in PVC mm. 50**  
 150 m. set  
 Tennis lines in PVC



**Art. RT10**  
**Stuoia livellatrice per campi in terra**  
**battuta m.2x1,5**  
 Levelling net m.2x1,5



**Art. 0934N**  
**Rete protezione**  
**polietilene verde annodata**  
**maglia cm. 4,5x4,5 sp. mm. 2**  
 Protection Net green polyethylene  
 mesh 4,5x4,5 cm.  
 knotted, thick 2 mm.



**Art. 40/S - 41/S**  
**Telo fondo campo tennis**  
**densità 90% o 70% mt.18x2**  
**con banda di rinforzo**  
 Tennis perimeter net density  
 90% or 70% dim. 18x2 meters



**Art. TE53083**  
**Tabellone segnapunti Tennis**  
**cm. 100x77 h. cifre cm. 12**  
**completo di agganci per la recinzione**  
 Tennis scoreboard 100x77 cm.



**Art. F166PST**  
**Tabellone**  
**elettronico**  
**portatile da tavolo**  
**per Tennis**  
 Portable Tennis  
 electronic  
 scoreboard



## TENNIS TAVOLO - Table Tennis



**Art. 568001**  
**Racchetta**  
**Ping Pong**  
**Dunlop**  
**Nitro**  
**(o modello simile)**  
Dunlop  
table tennis bat



**Art. 83925A**  
**Racchetta**  
**Ping Pong**  
**Dunlop**  
**Evolution 1000**  
**(o modello simile)**  
Dunlop  
table tennis bat



**Art. 48441**  
**Confezione 6 Palline**  
Set of 6 table tennis balls



**Art. 2C4118C**  
**Confezione 100 Palline**  
**1 stella colore bianco**  
Set of 100 table tennis balls

● pg.43



**Art. 17362**  
**Confezione 3 Palline**  
**Stiga 3 stelle Perform**  
Set of 3 Stiga table tennis balls



**Art. PP50**  
**Rete in polietilene**  
Net



**Art. E5019**  
**Rete Ping Pong**  
**regolabile portatile universale**  
Table tennis net adjustable length



**Art. 48448**  
**Set rete con paletti**  
Net with holder



**Art. PPP30**  
**Segnapunti per Ping Pong con numeri da 0 a 30 rinforzati**  
Table tennis scoreboard





**Art. TEC.I**  
**Tennis tavolo Tectonic indoor per interno**  
Indoor Table Tennis Tectonic

**Art. TEC.O**  
**Tennis tavolo Tectonic outdoor per esterno**  
Outdoor Table Tennis Tectonic



**Art. C250.I**  
**Tennis tavolo Cornilleau modello Sport 250 da interno**  
Indoor Table Tennis Cornilleau Sport 250

pg.43



**Art. C150S.O**  
**Tennis tavolo Cornilleau modello 150S da esterno**  
Outdoor Table Tennis Cornilleau 150S



**Tutti i tavoli sono pieghevoli e su ruote**  
All models are foldable and on wheels







**Art. C400M.O**  
**Tennis tavolo Cornilleau**  
**modello 400M da esterno**  
Outdoor Table Tennis  
Cornilleau 400M

pg.43



**Art. C500.I**  
**Tennis tavolo Cornilleau**  
**modello 500 da interno**  
Indoor Table Tennis  
Cornilleau 500



**Art. C510.O**  
**Tennis tavolo Cornilleau**  
**modello 510 da esterno**  
Outdoor Table Tennis  
Cornilleau 510





**Art. 8836G1 / 8836G**  
**Coppia Porte Rugby**  
**in alluminio verniciato**  
**m. 11 / m. 10 fuori terra**  
Rugby Goals  
in painted aluminium

## RUGBY

**New!**



**Art. M13537**  
**Pallone rugby**  
**Mondo Touche in PU**  
**con superficie granulare**  
Rugby training ball  
in synthetic leather



**Art. V71**  
**Pallone mini-rugby Trial**  
**in gomma monostrato**  
**gr. 350 dim. cm.15/27**  
Trial rubber mini-rugby Ball  
single stratum

pg.45

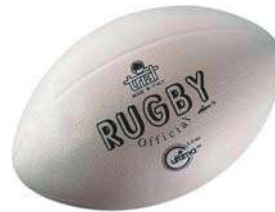

**Art. ULT71**  
**Pallone mini-rugby Trial**  
**in gomma doppio strato**  
**gr. 350 dim. cm.15/27**  
Trial rubber mini-rugby Ball  
double stratum

**Art. ULT70**  
**Pallone rugby Trial**  
**in gomma doppio strato**  
**gr. 450 dim. cm.19/28**  
Trial rubber rugby Ball  
double stratum



**Art. F1645X**  
**Pallone football americano**  
**in pelle sintetica**  
Wilson Extreme ball

pg.44

**Art. 993156/993157/993162**  
**Protezione imbottita per palo porta rugby**  
**h. cm. 200, modello**  
**quadrato oppure tondo**  
Soft Protection for rugby goal post, square  
and round shape, height 200 cm.

**Art. 993164**  
**Protezione copri bandierina**  
**cm.10x10x100h.**  
Protection for rugby flag pole,  
10x10x100 cm.





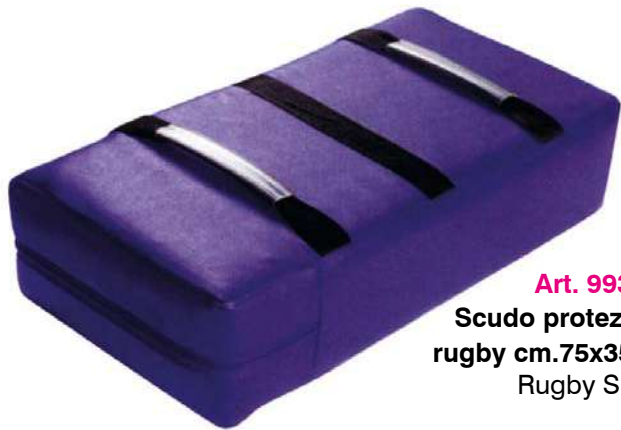

**Art. 993032**  
**Scudo protezione**  
**rugby cm.75x35x15**  
 Rugby Shield



**Art. 6M18**  
**Confezione 100 Tacchetti rugby**  
**mm.18 in alluminio**  
 Rugby aluminium studs  
 18 mm. 100 piece pack



pg.45



**Art. PTI.RU**  
**Lavagna Rugby bifacciale**  
**cancellabile cm. 35x22**  
 Rugby tactical board  
 35x22 cm.

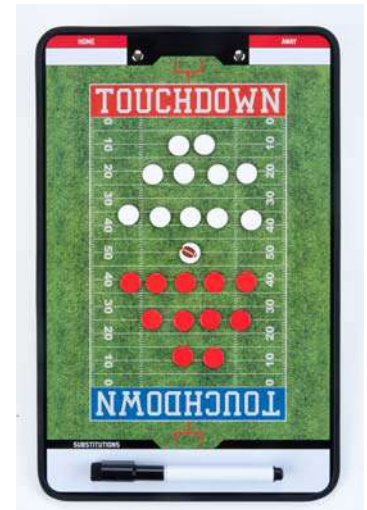

**Art. PTI.FA**  
**Lavagna Football**  
**Americano**  
**bifacciale cancellabile**  
**cm. 35x22**  
 Football tactical board  
 35x22 cm.

**Art. 993151 / 993153JR**  
**Sacco placcaggio rugby h. cm.140 o cm.120**  
**diam. cm. 45 o cm. 35, con 3 maniglie**  
 Sac for Tackling height 140 or 120 cm.  
 diameter 45 or 35 cm. with 3 handles



**Art. FLFT**  
**KIT FLAG FOOTBALL composto da cintura regolabile e 2 flag - vari colori**



## PISCINA - Swimming Pool



**Art. E1901**  
Cuffia in poliestere  
(bicolore solo taglia adulto)  
Polyester cap

pg.43 pg.44



**Art. E1904**  
Cuffia in lycra  
Lycra cap



**Art. E1127**  
Cuffia in silicone  
Silicone cap



**Art. E2607**  
Stringinaso con  
cuscinetti in silicone  
Silicone nose-clip



**Art. E2608**  
Tappi auricolari in silicone  
automodellanti - Set da 4 pz.  
Silicone auricular plugs



**Art. E2620**  
Occhialini  
da piscina Junior  
Junior glasses



**Art. E2626**  
Occhialini  
da piscina adulto antifog  
monoscocca morbida  
Senior antifog glasses



**Art. E2618**  
Occhialini da piscina adulto antifog  
monoscocca morbida  
custodia con cerniera  
Senior soft antifog glasses  
case with zip



**Art. E2622**  
Occhiale maschera  
antifog monoscocca morbida  
con custodia rigida  
Mask glasses antifog with case



**Art. E2639**  
Tavoletta per piscina adulto  
professionale cm.40x27  
Senior professional board



**Art. E2641**  
Ostacolatore monoblocco  
cm.15x22x7,5



**Art. E2650**  
Paio palette palmari forate  
cm.21x16 (misura S, M, L)



**Art. E2660**  
Copriscarpe in PVC  
set da 2000 pezzi - misura unica





**Art. E848**  
Marsupio per nuoto potenziato  
Swimming pouch



**Art. E845**  
Paracadute per nuoto potenziato  
Swimming parachute



**Art. E853**  
Elastico per nuoto trattenuto - mt. 2  
Swimming elastic



**Art. E482**  
Paio polsire/cavigliere per aquagym mis. cm. 62x11x2  
Water aerobics wrist/ankle supports



**Art. E483**  
Paio manubri per aquagym cm.30 - diam. cm.14  
Water aerobics dumb bells

pg.44



**Art. E484**  
Cintura per aquagym cm.67x29x4  
Water aerobics belt



**Art. E474**  
Paio clavette per aquagym  
Water aerobics clubs



**Art. E479/3**  
Zattera in espanso forata dim. cm.200x100x3  
Pierced mat



**Art. E470**  
Cilindro in materiale espanso per aquagym cm. 160 ø cm. 7  
Water aerobics bar



**Art. E2637/0**  
Paio manicotti arrotolabili doppia valvola (3/6 anni)  
Brackets



**Art. E480/1**  
Connettore per cilindro mis. cm.14 - 2 fori  
Bar connector



**Art. AQSA**  
Step per aquagym impilabile ad incastro cm.70x35x19  
Water aerobics step cm.70x35x19



## PALLANUOTO - Waterpolo

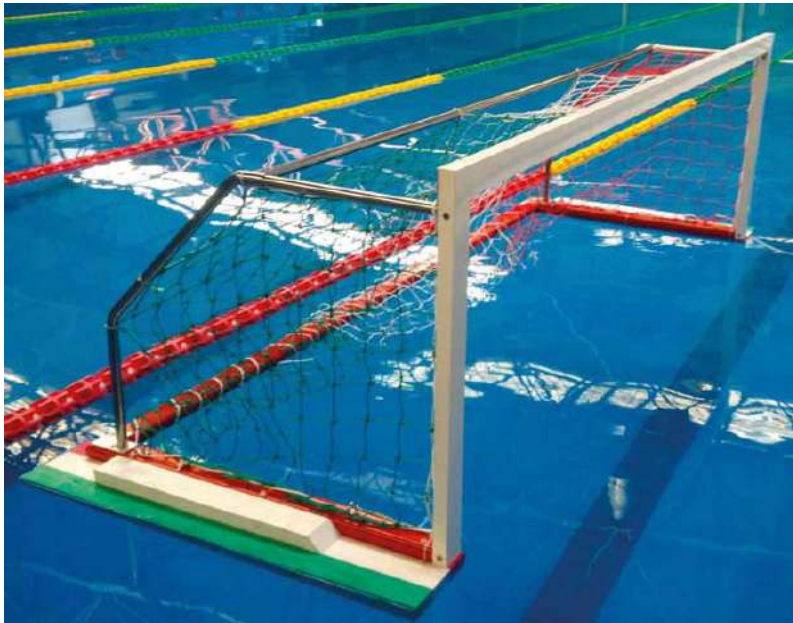

### Art. PPNR

#### Coppia Porte da pallanuoto per partite ufficiali (reti incluse)

Pair of Waterpolo Goals for official matches (nets included)

- Realizzate a norma F.I.N.A.
- Luce interna specchio di porta m.3x0,90
- Ingombro totale m.3,50x0,975x1,25
- Specchio di porta tubolare alluminio mm.75x40x1,85 di colore bianco
- Base tubolare alluminio mm.80x40x3 colore rosso
- Accessori acciaio inox AISI 316
- Galleggianti schiuma espansa a cellule chiuse densità 350% - Peso kg.30

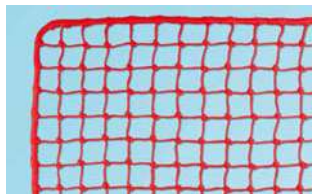

### Art. 175P

#### Coppia reti per porte pallanuoto

Waterpolo Nets

● pg.43



### Art. AQPP

#### Coppia Miniporte da pallanuoto in PVC m. 1,5x0,8 complete di reti

Pair of Waterpolo PVC Mini-goals 1,5x0,8 m. nets included



### Art. E80

#### Pallone pallanuoto Trial in Eva gr. 420 Ø 21 cm. (ad esaurimento)

Waterpolo Trial ball in Eva (until available)



### Art. E6890

#### Pallone pallanuoto

Waterpolo Ball



### Art. 30415

#### Set cuffie pallanuoto con numero - set 13 pezzi colore bianco o blu

13 Waterpolo caps with numbers



## BADMINTON



**Art. P160**  
**Rete**  
**Badminton**  
**cm. 610x70**  
Badminton Net

**V7700**  
**Impianto Badminton**  
**professionale in acciaio verniciato**  
**zavorrato, su ruote, con tendirete**  
**(rete esclusa)**  
Pro Badminton set (net not included)



**Art. 23461**  
**Racchetta Badminton**  
**in acciaio/alluminio**  
Badminton Racket  
in steel/aluminium

pg. 45



**Art. PAC12**  
**Racchetta Badminton**  
**in grafite/alluminio**  
Badminton Racket  
in graphite/aluminium



**Art. 22309**  
**Confezione**  
**6 Volani**  
**Badminton**  
**interamente**  
**in plastica**  
Plastic  
Shuttlecock  
6 piece pack

**Art. AS85**  
**Confezione**  
**6 Volani**  
**Badminton**  
**con capsula**  
**in sughero**  
Cork tip  
Shuttlecock  
6 piece pack

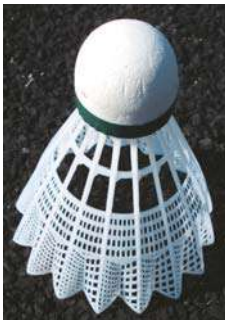

**Art. JIN**  
**Impianto**  
**Mini Badminton**  
**mt. 4,20x1,50**  
**telescopico portatile**  
**completo**  
**di rete e borsa**  
Portable Mini  
Badminton  
set mt. 4,20x1,50  
with net and bag

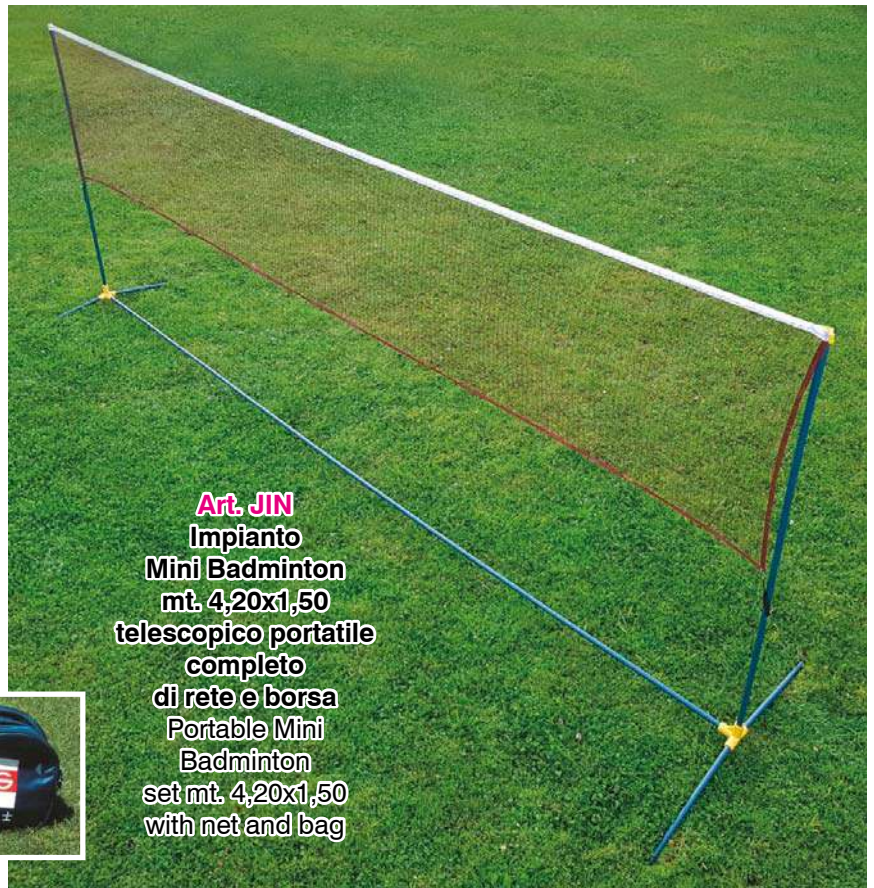



## HOCKEY



**Art. S05128**

**Coppia porte per Hockey su pista  
in acciaio verniciato**  
Pair of Hockey Goals in painted steel



**Art. S05122**

**Coppia porte per Hockey su prato  
in legno e acciaio verniciato**  
Pair of Hockey Goals in wood  
and painted steel



**Art. PUH01**  
**Pallina Unihockey**  
Unihockey ball

pg.44

**Art. F806**

**Coppia porte unihockey  
in acciaio verniciato con reti,  
dim. cm.150x110**  
Pair of unihockey Goals in painted steel 150x100 cm.



**Art. S05134**

**Set Unihockey composto  
da 6+6 bastoni cm.80+10 e 3 palline**  
Set Unihockey made of 6+6 sticks and 3 balls

**Art. H1**

**Coppia RETI per porte da Hockey pista  
(indoor) in polipropilene maglia mm.45  
cm.300x200x100x100**  
Pair of Track Hockey Goal nets

**Art. H2**

**Coppia RETI per porte da Hockey  
ghiaccio in polipropilene complete di rete  
di sbarramento, maglia  
mm.20 - cm.193x122x75x120**  
Pair of Ice Hockey Goal nets

**Art. H3**

**Coppia RETI per porte da Hockey  
prato in polipropilene complete di rete  
di sbarramento, maglia  
mm.45 - cm.366x214x90x122**  
Pair of Field Hockey Goal nets

**Art. H4**

**Coppia RETI per porte da Hockey rotelle in  
polipropilene complete di rete di sbarramento,  
maglia mm.20 - cm.185x122x74x110**  
Pair of Roller Hockey Goal nets

## BASEBALL



**Art. TMB01**  
**Mazza Baseball supersoft Trial**  
 lunghezza cm.71 diametro cm.4/5  
 peso gr.460  
 Supersoft Trial Baseball bat



**Art. S05152**  
**Mazza Baseball regolamentare in legno**  
 Wooden Baseball bat



**Art. S05156**  
**Palla Baseball rivestita in pelle sintetica**  
 Baseball ball

pg.45



**Art. S05158**  
**Guantone Baseball in pelle sintetica**  
 misura senior  
 Senior Baseball glove



**Art. PTI.BB**  
**Lavagna Baseball bifacciale cancellabile**  
 cm. 35x22  
 Baseball tactical board  
 35x22 cm.

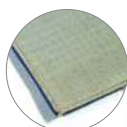

appoggio antiscivolo



imbottitura interna



**Art. P21006**  
**Set basi didattiche antiscivolo colorate**  
 Set of didactic anti-skid bases

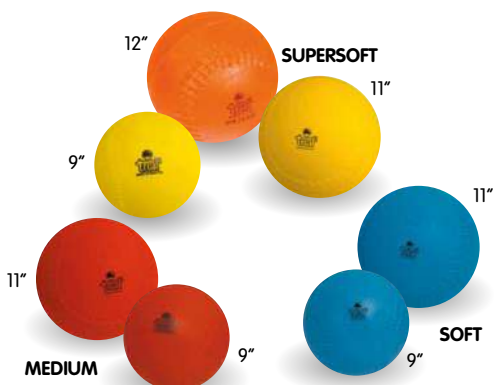

**Art. BSB.8**  
**Set 7 Palle Baseball/Softball Trial in gomma super soft**  
 diametri e grammature assortiti  
 Set of Trial Baseball/Softball balls



**Art. T21063**  
**Batting tee Trial supersoft**  
 altezza regolabile da cm. 65 a cm. 86  
 base diametro cm. 20,5  
 peso Kg. 3  
 Trial Batting tee adjustable height



## BOXE



**Art. 992030**

**Sacco Boxe in vinile Kg.30**  
Vinyl boxing bag kg.30



**Art. 992040**

**Sacco Boxe in vinile Kg.40**  
Vinyl boxing bag kg.40



**Art. 992050**

**Sacco Boxe in vinile Kg.50**  
Vinyl boxing bag kg.50

**New!**



**Art. C3003S**

**Gancio a molla  
ammortizzatore per  
sacco boxe**  
Spring for boxing bag

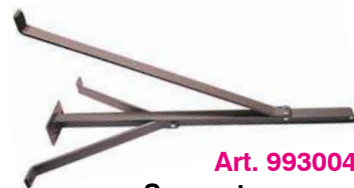

**Art. 993004**

**Supporto a muro  
per sacco boxe**  
Iron wall support for  
boxing bag



**Art. 992840**

**Sacco Boxe basculante  
h. cm. 170 zavorrato con  
sacchi di sabbia (inclusi)**  
Self-straightening boxing bag  
height cm.170



**Art. 992804**

**Sacco Fit Boxe con pedana  
riempibile con acqua o sabbia,  
altezza regolabile (max cm. 220)**  
Freestanding Fit Boxing bag  
adjustable height



**Art. F350**

**Kit pera  
su mensola**  
Pear for boxing

pg.53





**Art. 42233A**  
**Casco Boxe**  
misure S,M,L,XL  
Boxing helmet



**Art. 44613A**  
**Set protezioni**  
parastinco +  
parapiede  
misure S,M,L,XL  
Shin/foot protections



**Art. 17211**  
**Coppia Fasce Boxe**  
Boxing bandages

pg.53



**Art. 54613A**  
**Guanti da Sacco in PU**  
taglie S,M,L,XL  
Bag gloves



**Art. 21796**  
**Guanti Fit Boxe**  
taglie S,M,L,XL  
Fit Boxing gloves



**Art. 74613A**  
**Guanti MMA in PU**  
taglie S,M,L,XL  
MMA gloves



**Art. 84613A**  
**Guanti Boxe**  
per combattimento  
non omologati  
8/10/12 oz.  
Boxing gloves



**Art. GN083**  
**Guanti Boxe**  
Leone Flash 10 oz.  
Leone Boxing  
gloves

## ARTI MARZIALI - Martial Arts



**Art. 24772**  
Divisa judo con cintura  
misure da 00 (cm.120)  
a 7 (cm.200)  
Judo strip with belt

pg.53



**Art. 24773**  
Divisa karate con cintura  
misure da 00 (cm.120)  
a 7 (cm.200)  
Karate strip with belt



**Art. 23271**  
Cintura judo/karate 100% cotone  
colori: nero, blu, arancio, marrone, verde, giallo, rosso  
misure da 1 a 7  
Judo/Karate belt



**Art. 23271.B**  
Cintura judo/karate 100% cotone  
bicolore: bianco/giallo, giallo/arancio,  
arancio/verde, verde/blu,  
blu/marrone - misure da 1 a 7  
Bicoloured Judo/Karate belt



**Art. F163**  
Tabellone elettronico  
portatile da tavolo  
per Kick-Boxing  
Kick-Boxing portable  
electronic  
Scoreboard



**Art. F162**  
Tabellone elettronico  
portatile da tavolo  
per Karate  
Karate portable  
electronic  
Scoreboard

**Art. F150**  
Fight Timer da parete  
cm.56x19x4 - kg.1,6  
Fight Timer





## PROTEZIONI MURARIE E PER COLONNE - Wall protections



PREVENTIVO SU RICHIESTA  
PRICES ON REQUEST



**Art. B2085 / B2066**

**Protezioni murarie e per colonne in vari spessori sagomate su misura in EVA oppure PE alta densità rivestito in PVC fissaggio tramite occhiellature perimetrali, velcro oppure colla - per interno ed esterno**  
Customized wall and column protections various thickness for indoor and outdoor

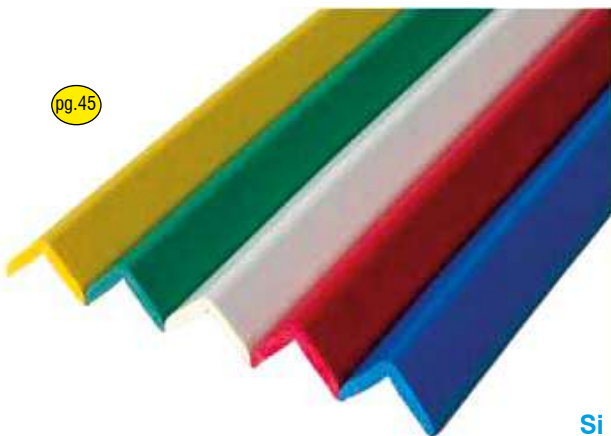

pg.45

**Art. A10100 / A10150 / A10200**  
**Protezioni paraspigoli in PVC espanso coestruso non ignifugo spessore cm. 1 larghezza cm. 5+5 in vari colori lunghezza cm. 100-150-200**

PVC Edge Protections 1 cm. thick width 5+5 cm. length 100-150-200 cm.

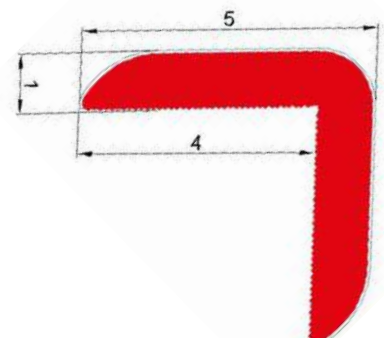

**Si applicano rapidamente mediante normale silicone**  
They are installed quickly by means of standard silicone

## MATERASSI - TAPPETI - Mats



### Art. B2001/ ... /B2016

Materassi di caduta realizzati in gommapiuma di varie densità con fodera di rivestimento in PVC antimuffa, antibatterica, ignifuga Cl.2

(vedere listino per le dimensioni)

Mats of various dimensions and thickness

Materassi e fodere disponibili anche con fondo antiscivolo (dettagli sul listino prezzi)  
Mats and covers also available with anti-skid bottom (details on the price list)

pg.46 pg.47

### Art. B2033/ ... /B2047

Fodere di ricambio in PVC antimuffa, antibatteriche, ignifughe Cl.2

(vedere listino per le dimensioni)

Spare covers for mats various dimensions



### Particolare Art. B2014/ B2015/B2016

(i materassi cm.200x400 sono costituiti da 2 pezzi tagliati a 45° e tenuti insieme da strisce di velcro)

### Art. B2214/ ... /B2219

Materassi di caduta pieghevoli (vedere listino per le dimensioni)

Foldable Mats

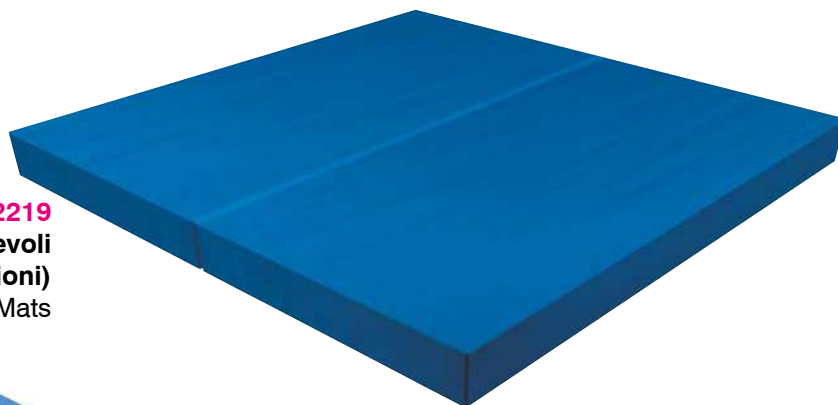

pg.47

### Art. B2228/ ... /B2231

Tappeti Gym Mat dim. cm.200x100 spessore cm.3-4-5-6

ad alta densità in polietilene a cellule chiuse (per uscita attrezzi)

High density Gym Mats

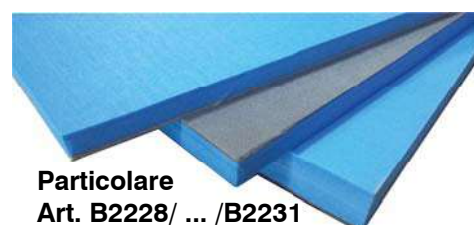

Particolare Art. B2228/ ... /B2231

**Più rigidi  
dei materassi in gommapiuma  
Harder than foam rubber mats**



**Art. S00676**  
**Carrello porta materassi**  
**cm. 200x100**  
**in acciaio verniciato**  
**mobile su ruote**  
Mat Trolley in painted steel size  
200x100 cm. on wheels



pg.46



**Art. S00678**  
**Carrello porta materassi**  
**in verticale cm. 250x105**  
**in acciaio verniciato**  
**mobile su ruote**  
**(elastici inclusi)**  
Vertical mat Trolley in painted  
steel size 250x105 cm.  
on wheels  
(elastics included)

pg.47



**Art. TEST.M**  
**Tappeto Mat Test cm.100x370**  
**con scala centimetrata da 0 a cm. 300**  
Mat Test 100x370 cm.

**Per allenamento tuffi portieri ed acrobazie giocatori**  
**For GK dive and players' acrobatic shooting training**

pg.46

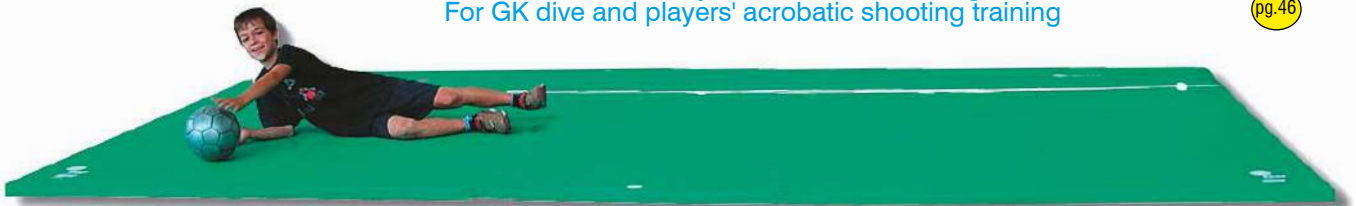

**Art. BGAP13**  
**Tappeto ammortizzante pieghevole dimensioni cm. 200x450 spessore cm. 3,5**  
**superficie in vinile monospalmato - fondo antiscivolo, imbottitura densità 40 Kg/mc**  
Foldable soft mat for goalkeeper and players' safe dives - size 200x450 cm. 3,5 cm. thick



## TATAMI

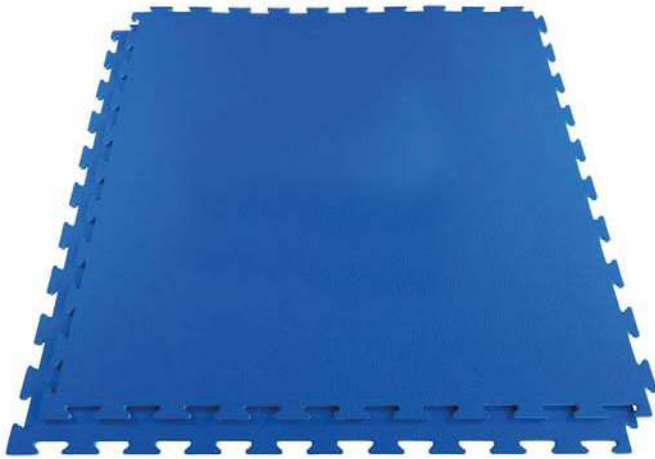

**Art. R10X**

**TATAMI ad incastro in EVA cm.100x100x1  
colore blu con 4 bordi  
superficie lavabile, antiscivolo  
EVA Tatami soft flooring 100x100x1 cm.**

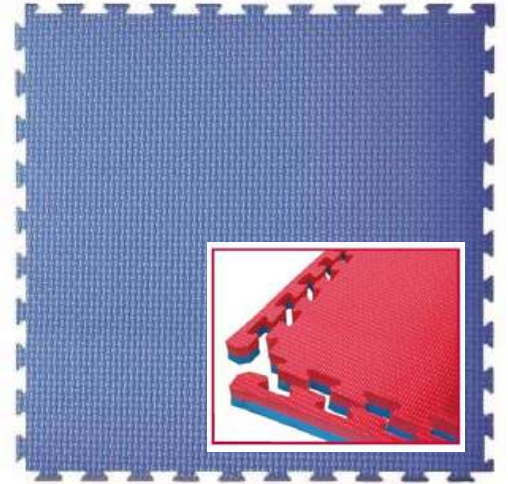

pg.53 pg.54

**Art. MAT02 / MAT04**

**TATAMI ad incastro cm.100x100x2  
o cm.100x100x4 rosso/blu con 4 bordi  
superficie lavabile, antiscivolo, antifunghi,  
antibatterica, anallergica, certificato EN71  
Tatami soft flooring 100x100x2 cm./100x100x4 cm.**

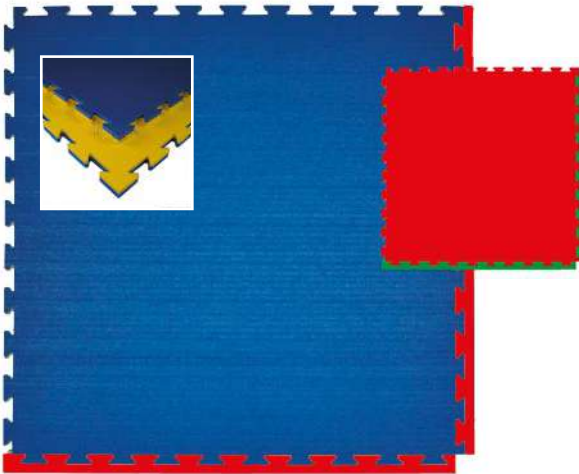

**Art. TX-K20**

**TATAMI Karate K20  
cm. 100x100x2 ad incastro, reversibile  
in polietilene espanso reticolato  
incluso bordo protettivo perimetrale  
colori: verde/rosso, rosso/blu, giallo/blu  
(ordine minimo 8 pezzi)  
TATAMI K20 100x100x2 cm.  
reversible, perimetric frame included  
colors: red/green, red/blue, yellow/blue  
(minimum order 8 pieces)**

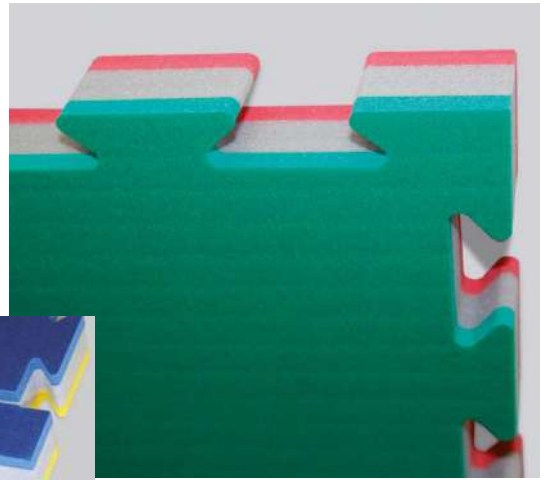

**Art. TX-J40**

**TATAMI Judo J40  
cm. 100x100x4 ad incastro, reversibile  
in polietilene espanso reticolato  
incluso bordo protettivo perimetrale  
colori: verde/bianco/rosso, giallo/bianco/blu  
(ordine minimo 4 pezzi)  
TATAMI J40 100x100x4 cm. reversible,  
perimetric frame included  
colors: red/white/green, yellow/white/blue  
(minimum order 4 pieces)**



**Art. TX-2010**

**TATAMI tradizionale  
cm. 200x100x4 in PU  
densità 230 Kg/mc  
rivestito in PVC  
con fondo antiscivolo  
colori: blu, verde, rosso, giallo  
(ordine minimo 4 pezzi)  
TATAMI 200x100x4 cm.  
in PU density 230 Kg/mc  
cover with anti-skid PVC stratum  
colors: blue, green, red, yellow  
(minimum order 4 pieces)**



## GINNASTICA - Gymnastic



**Art. S00352**

**Armadio porta attrezzi con vano portavalori  
a 4 ripiani in lamiera  
dimensioni cm. 100x45x200h  
Equipment locker with safe-deposit box**



**Art. S00354**

**Armadio porta attrezzi a 4 ripiani  
in lamiera dimensioni cm. 100x45x200h  
Equipment locker**

pg.48



**Art. S00356**

**Armadio porta attrezzi  
in lamiera dimensioni  
cm. 120x45x200h  
a 4 ripiani  
e porte scorrevoli  
Equipment locker with  
sliding doors**

pg.48

**Art. S00362**  
**Mobile porta attrezzi su ruote  
Equipment trolley on wheels**

pg.23

**Art. F406**  
**Armadio porta  
attrezzi in acciaio  
zincato a pareti  
smontabili,  
con ruote  
dimensioni  
cm. 156x76x163h  
Equipment locker in  
galvanized steel  
on wheels**





**Art. CAGL**

**Coppia anelli in legno di faggio  
con cinghie nylon regolabili**

Pair of wooden rings with adjustable nylon belts

pg.47

**Art. S0002**  
**Coppia anelli  
in legno lamellare**  
Pair of wooden rings



**Art. S00018**

**Confezione da 8 pani  
magnesio gr. 55**  
Chalk blocks



pg.48



**Art. E8000**

**Paio scarpette in pelle  
per ginnastica ritmica  
colore nero o bianco**  
taglie da 26 a 46

Pair of shoes for rhythmic gym  
color black or white



**Art.S00512**

**Mensola porta clavette**  
Club wall holder

**Art. P00510/S00502/S00506**  
**Coppia clavette in nylon,  
in legno a collo lungo e collo corto**  
Wooden and plastic clubs

pg.48

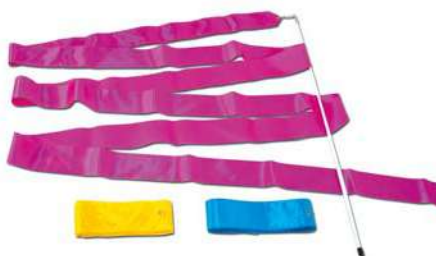

**Art. P01210**

**Nastro per ginnastica  
ritmica m. 6**  
Rhythmic  
gym streamer



**Art. CS5**

**Corda salto  
per ritmica  
m. 3**

Jumping rope



**Art. CS7**

**Corda salto  
per ritmica  
m. 3 piombata**  
Weighted jumping  
rope



**Art. S01482**

**Tamburello  
completo  
di batacchio**  
Rhythmic  
gym drum

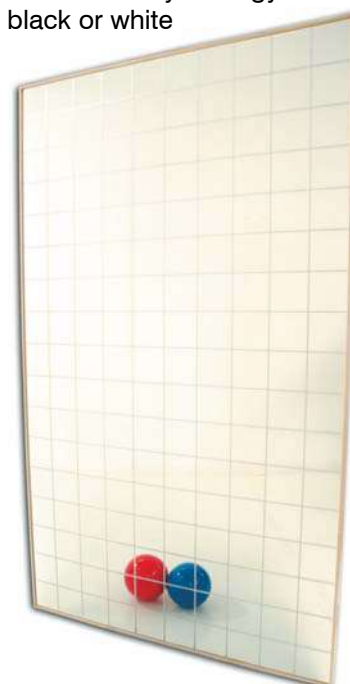

pg.49

**Art. S01624**

**Specchio quadrettato  
con cornice  
in legno da fissare a parete**  
misure cm.200x100  
Wall mirror with wooden frame





**Art. S01606**  
**Supporto per sbarra regolabile da fissare a parete**  
 Support for bar to be fixed on the wall

pg.49



**Art. S01608**  
**Supporto per sbarra regolabile da fissare a terra**  
 Support for bar to be fixed on the floor

**Art. S01602**  
**Sbarra per danza in legno (pezzo unico fino a 4 metri)**  
 Wooden bar



**Art. 1156TE**  
**Supporto per sbarra regolabile da cm. 78 a cm. 140 in acciaio con base autoportante economica**  
 Cheap freestanding support for bar



**Art. S00304**  
**Coppia ceppi Baumann in legno**  
 Pair of Baumann blocks in wood

pg.48



**Art. S00302**  
**Coppia appoggi Baumann in legno**  
 Pair of Baumann supports in wood

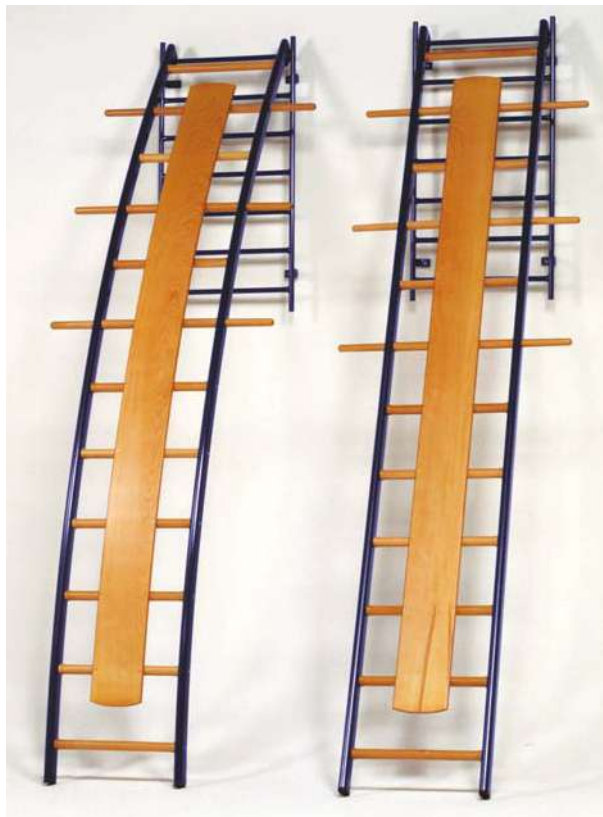

**Art. S01052 / S01054 / S01060 / S01062**  
**Scale ortopediche dritte o curve, a parete o trasportabili**  
 Orthopaedic ladders

pg.49



**Art. S00772/S00774**  
**Fune per salita**  
 lunghezza m. 5/m. 6  
 Climbing Rope  
 length 5 m./6 m.



**Art. S00754 / S00756**  
**Palchi di salita**  
 (dettagli sul listino prezzi)  
 Climbing apparatus

**New!**



**Art. S00792/2 - S00792/3**  
**Sistema di sospensione ed accostamento a parete per attrezzi da arrampicata (funi, pertiche, scale)**  
 Varnished steel frame for supporting and sliding to the wall, once not in use, wall climbing equipments (ropes, poles and ladders)



pg.48

**Art. S00056 / S00058 / S00052 / S00054**  
**Assi di equilibrio ad altezza fissa e graduabile**  
 Balance beams adjustable and fixed height



pg.49

**Art. S00060 / S00064**  
**Trave di equilibrio in alluminio rivestito lunghezza mt.5 ad altezza regolabile (a norme F.I.G.) oppure ad altezza fissa**  
 Balance beam 5 meters adjustable height 50-120 cm. or fixed height



pg.49



**Art. S00204 / S00206 / S00208 / S00210**  
**Pedane elastiche con piano di battuta in legno, ricoperto in gomma, ricoperto in moquette o a doppio molleggio**  
 Springboards



**Art. S00104**  
**Cavallo per volteggio senza maniglie rivestito in cuoio sintetico altezza regolabile**  
 Vaulting buck adjustable height

pg.48



**Art. V1168**  
**Cavallina regolamentare rivestita in cuoio sintetico altezza regolabile da cm. 90 a cm.130**  
 Vaulting buck adjustable height



pg.49

**Art. S00218 / S00220**  
**Tappeto arrotolabile per pedana corpo libero in poliuretano e moquette, rotolo da m. 15/25 altezza cm. 100/200**  
 Gymnastic moquette floor, roll m.15/25 long 100/200 cm. height



pg.13

**Art. S00914/S00918/S00920**  
**Panche svedesi**  
 Swedish benches





**Art. S00252**  
**Sbarra orizzontale**  
**per volteggi regolabile in**  
**altezza, fissaggio**  
**a terra con tiranti**  
Vaulting bar adjustable height



**Art. S00160**  
**Parallela Scolastica a losanga**  
**ad altezza fissa, staggi in legno lamellare**  
Scholastic parallels fixed height

pg.49



**Art. S00156**  
**Parallela Asimmetrica Femminile in acciaio verniciato**  
**su basamento pesante, montanti graduabili,**  
**staggi in legno lamellare regolabili in altezza e larghezza**  
Asymmetrical bars adjustable height



**Art.S00152**  
**Parallela Maschile in acciaio verniciato**  
**su basamento pesante, montanti graduabili,**  
**staggi in legno lamellare**  
**regolabili in altezza e larghezza**  
Parallels bars adjustable height

## ATLETICA - Track & Field



**Art. PBS-SI**  
**Blocco di partenza da allenamento in acciaio zincato**  
 Starting Blocks in galvanized steel



**Art. BL01**  
**Paio Blocchi di partenza in gomma per palestra**  
 Pair of gym Starting Blocks in rubber for beginners



**Art. S02010/PPA38**  
**Testimoni per staffetta in PVC o omologati in alluminio**  
 PVC or aluminium relay baton



pg.49

pg.50

**Art. TYVS**  
**Pettorali in tyvek per gare atletica cm.21x16h personalizzabili**  
 Numbers for competitions



**Art. S02112**  
**Megafono a transistor portatile**  
 Handy megaphone



**Art. F601**  
**Ostacolo per Atletica in ferro zincato graduabile cm. 50-60-76,2**  
 Adjustable height hurdle in galvanized steel



**Art. S02126**  
**Pistola a tamburo per starter**  
 Starter's revolver gun



**Art. F602**  
**Ostacolo per Atletica in ferro zincato graduabile cm. 76,2-84-91,4**  
 Adjustable height hurdle in galvanized steel

**Art. S02072**  
**Ostacolo per Atletica in alluminio anodizzato graduabile cm. 76,2-84-91,4-100-106,7 omologato I.A.A.F.**  
 Adjustable height hurdle in anodized aluminium according to I.A.A.F. standards



**Art. S02064**  
**Ostacolo per Atletica in acciaio graduabile cm. 76,2-84-91,4-100-106,7**  
 Adjustable height hurdle in steel



**Art. VSH-222**  
**Ostacolo per Atletica Vinex olimpionico in ferro zincato omologato I.A.A.F.**  
 Adjustable height hurdle in galvanized steel according to I.A.A.F. standards





**Art. S02552**  
Coppia ritti salto in alto scolastici altezza cm.200  
Scholastic High Jump height 200 cm.



**Art. S02554**  
Coppia ritti salto in alto scolastici in acciaio zincato altezza cm.230  
Scholastic High Jump height 230 cm.



**Art. S02556**  
Coppia ritti salto in alto in acciaio zincato periscopici h. cm.250  
High Jump height 250 cm.

pg.52



**Art. S02558**  
Coppia ritti salto in alto in acciaio zincato periscopici da competizione h. cm.260  
Competition High Jump height 260 cm.



**Art. S02584**  
Piattaforma zincata di sostegno e sollevamento zona di caduta  
Galvanized steel support platform for landing mats

**Art. B2080/B2081**  
Zone di caduta salto in alto  
High Jump landing mats



**Art. S02566**  
Asta segnalimite per salto in alto in PTE  
High Jump crossbar with soft PTE cylinders

pg.52



**Art. PVS-CPTA**  
Coppia ritti per salto con l'asta in alluminio graduabili fino a cm. 650  
Pair of aluminium pole vault stands

**Art. B2077/B2078**  
Zone di caduta salto con l'asta  
Pole vault landing mats



**Art. S02570**  
Asticella segnalimite per salto in alto m. 4 in vetroresina  
High Jump fiberglass crossbar



**Art. TT09/ ... /VT15**  
**Palle lancio**  
**in gomma Trial,**  
**varie grammature**  
Trial rubber throwing balls



**Art. VDL5/ ... /VDL72**  
**Palle getto anelastiche**  
**in gomma Trial**  
**per indoor**  
**varie grammature**  
Trial shot balls  
in rubber for indoor



**Art. S02486/ ... /S02496**  
**Palle getto in metallo verniciato**  
**tarate, varie grammature**  
Metal shot balls



**Art. S02510**  
**Pedana per lancio del peso**  
**in acciaio zincato**  
Galvanized steel shot put throwing circle

pg.51

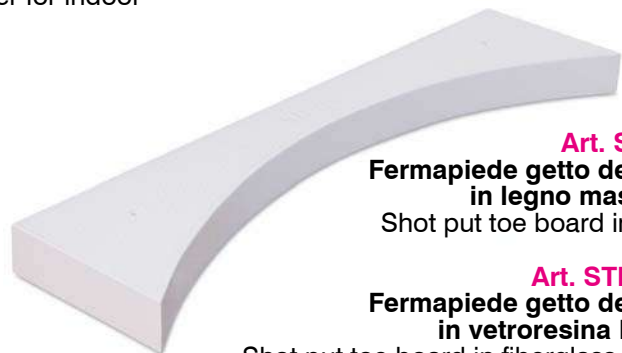

**Art. S02512**  
**FermapiEDE getto del peso**  
**in legno massiccio**  
Shot put toe board in wood

**Art. STB-F100**  
**FermapiEDE getto del peso**  
**in vetroresina I.A.A.F.**  
Shot put toe board in fiberglass I.A.A.F.



**Art. CT6**  
**Chiodo per scarpa**  
**in acciaio da mm.6 modello**  
**Albero di Natale**  
Shoe steel stud 6 mm.

pg.50



**Art. P15020**  
**Pedana Lancio in neoprene espanso**  
**per allenamento lancio disco, giavellotto, peso,**  
**martello e salto in lungo**  
Training toe board

pg.52



**Art. P9**  
**Chiodo per scarpa in acciaio da**  
**mm.9 modello Pyramid**  
Shoe steel stud 9 mm.



**Art. LM0.5/ ... /LM5**  
**Martelli sicuri supersoft**  
**in gomma Trial**  
**varie grammature**  
Supersoft Trial hammers

pg.51

pg.52



**Art. PM2/ ... /PM10**  
**Martelli in acciaio da allenamento Polanik**  
Polanik steel hammers





**Art. DSK1/ ... /DSK2**  
**Dischi in gomma Trial varie grammature**  
 Discus in rubber Trial



**Dischi Jet speciali per avviamento al lancio con peso distribuito sulla parte esterna per favorire la penetrazione nell'aria**  
 Special Jet discus with weight distributed mainly on the external perimeter in order to increase air penetration

**Art. JET03 / JET05 / JET1**  
**Dischi Jet in gomma Trial**  
 Kg. 0,3/0,5/1  
 Jet discus in rubber Trial

pg.50



**Art. DT0.4/ ... /DT1**  
**Dischi Trial a 3 impugnature in gomma approvati I.A.A.F. per attività scolastica**  
 Trial discus approved by I.A.A.F. for school training

**Art. W4T/ ... /W10T**  
**Giavellotti Polanik in lega leggera puntale acciaio varie grammature**  
 Polanik Javelins in light alloy with steel edge in various weights



**Art. TPD075/ ... /TPD3**  
**Dischi in plastica bordati in acciaio Polanik**  
 Polanik discus in plastic-steel

**Art. CPD1/ ... /CPD2**  
**Dischi in plastica bordati in acciaio Polanik - omologati I.A.A.F.**  
 I.A.A.F. Polanik discus in plastic-steel



**Art. TRTJ**  
**Turbo Jav per avviamento al lancio**  
 Turbo Jav for throwing introduction



**Art. P15262**  
**Junior Jav in polietilene espanso**  
 cm. 88 grammi 50

pg.51

**Art. JAL-C400/ ... / JAL-C800**  
**Giavellotti Vinex in lega leggera puntale in acciaio varie grammature**  
 Vinex Javelins in light alloy with steel edge in various weights

pg.50



**Art. VMH**  
**Vortex per avviamento al lancio del giavellotto e per football americano**  
 Vortex for throwing introduction



**Art. VMH.J**  
**Mini Vortex gr. 40 lunghezza cm. 17**

## PILATES



**Art. EVA.P**

**Mattoncino pilates in eva**  
cm.22,5x14,5x7,5h  
Block for pilates

pg.54



**Art. MPS30**

**Mattoncino pilates gonfiabile**  
Trial soft gr. 300 cm.12x24x3,5h  
Inflatable block for pilates

**Art. MPS50**

**Mattoncino pilates gonfiabile**  
Trial soft gr. 500 cm.11,3x24x5,5h  
Inflatable block for pilates



**Art. BA4**

**Palla tender per pilates**  
ø cm.20 - gr. 180  
super soffice e sicura  
Trial rubber tender ball  
for pilates



**Art. AHF-065/AHF-066**

**Sfera tonificante**  
verde kg.1 / viola kg.1,5  
Toning balls

**Art. AHF-045**

**Palla per yoga**  
ø cm.25  
Yoga ball



**Art. TR38**  
Toning ring

pg.54



**Art. AHF-001**

**Coppia sfere per massaggi**  
verde ø cm.7,5  
viola ø cm.9  
Massage balls



**Art. AHF-020**

**Power grip ball**



pg.20

**Art. B55 / B75**  
**Relax Ball Trial**  
ø cm.5,5 / 7,5  
Relax Ball

**Art. 995025**

**Cilindro pieno**  
Foam roll

lunghezza cm. 90

ø cm.15

Foam roll not  
inflatable



**Art. FY9512**

**Fitball roller**  
gonfiabile  
diametro cm.18  
Fitball roller inflatable



pg.54

**Art. 995025BIS**  
**Mezzo cilindro**  
pieno Foam roll  
lunghezza cm. 90  
altezza cm.7,5  
Half Foam roll  
not inflatable



**Art. AHF-044**  
**Rullo massaggio**  
lunghezza cm.33  
ø cm.14  
Massaging roll



**Art. AHF-111**  
**Rullo massaggio**  
con impugnature  
cm.53 ø cm.4,5  
Massaging roll



pg.22



**Art. TBSA/TBSB**

**Palla Boa autobilanciante in gomma** Trial  
oscilla ma torna al suo posto senza rotolare,  
stabile, ideale per correggere la postura,  
monocolore per adulti/bicolore per bambini  
Trial rubber Boa Ball swings but comes back  
to its original position - very good for postural  
therapy for adults and children



## PALLAPUGNO - BOCCE - TAMBURELLI



pg.54

**Art. BA1**  
Air Ball Trial Ø cm. 12 gr. 100  
morbida e rimbalzante  
(ideale anche per pallapugno)  
Trial Air Ball



**Art. M05010**  
Pallapugno FIPAP  
diametro cm. 14  
FIPAP pallapugno



pg.55

**Art. ST14**  
Palla Canguro Ø cm. 45  
Trial Cangaroo Ball



**Art. ST15**  
Palla Canguro Ø cm. 55  
Trial Cangaroo Ball



**Art. ST16**  
Palla Canguro Ø cm. 65  
Trial Cangaroo Ball



**Art. ASKB**  
Set 8 bocce in legno laccato  
diametro mm. 100  
con pallino diametro mm. 40  
Set 8 wooden bowls

pg.54

**Art. BTST12**  
Set 6+6 bocce supersoft  
con pallino e borsa  
Set of 12 supersoft  
bowls with bag



pg.55

**Art. P18110**  
Tamburello indoor  
diametro cm. 26  
(fino a 13 anni)  
omologato FIPT  
FIPT indoor  
tamburello Ø cm. 26



**Art. P18112**  
Pallina per tamburello  
depressurizzata  
indoor diametro cm. 6,5  
grammi 40  
Tamburello indoor depressurized ball

**Art. P18111**  
Tamburello indoor  
diametro cm. 28  
omologato FIPT  
FIPT indoor tamburello  
Ø cm. 28



**Art. S00552 / S00556**  
Funne per tiro alla funne  
lunghezza m. 15 / m. 25  
con indicazioni colorate  
Rope for tug of war  
length 15 / 25 meters

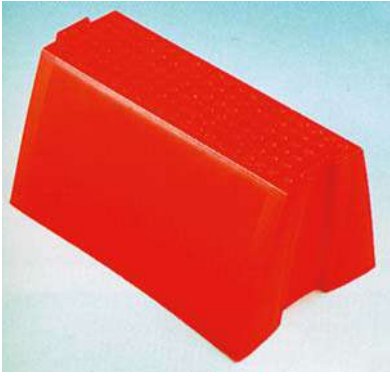

**Art. I-059**

**Set 10 mattoncini dritti**  
**cm. 25x16x13h**  
 Set of 10 straight bricks

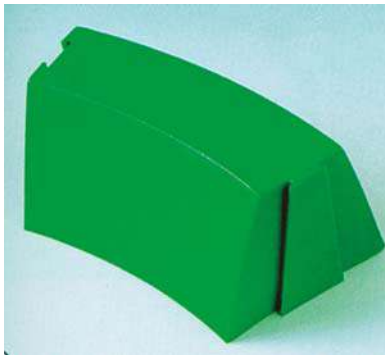

**Art. I-060**

**Set 10 mattoncini curvi**  
**cm. 22x16x13h**  
 Set of 10 curved bricks

pg.54

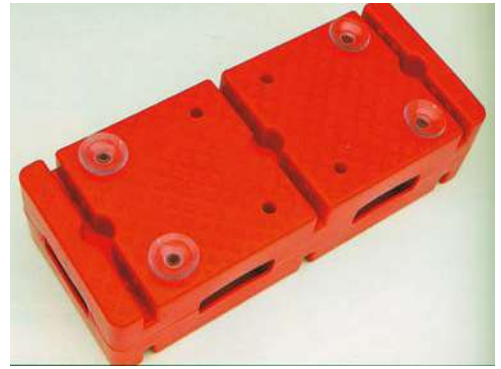

**Art. I-098**

**Blocco percorso**  
**cm. 30x15x10h**  
 Block for route



**Art. PCAD**

**Paracadute Ø cm. 300**  
 Parachute



**Art. I-061**

**Percorso equilibrio composto da**  
**5 assi + 6 mattoncini + 24 ventose**  
 Balance route



**Art. S00794**

pg.49

**Pannello per arrampicata in legno**  
**agganciabile a spalliera o quadro**  
**svedese**  
 Climbing board



**New!**

**Art. DDB12**  
**Bussola per**  
**orientering**  
**in plastica**  
**trasparente**  
**con laccio**  
 Compass

pg.55



**PALLA**  
**AVVELENATA**  
**Dodgeball**



**Art. TDB16**

**Palla per Dodgeball diametro cm. 16**  
**peso gr. 210 colore arancio fluo**  
 Dodgeball Ø cm. 16

pg.54

**Art. TDB20**

**Palla per Dodgeball diametro cm. 20**  
**peso gr. 230 colore giallo fluo**  
 Dodgeball Ø cm. 20





## SKATEBOARD - PATTINI - MONOPATTINI - FRISBEE



Art. SKM2401 Skateboard Junior cm.61



Art. SKM3103 Skateboard Senior cm.77,5



Art. F4-400  
Casco Skate  
taglie S, M, L  
Skate helmet

pg.54



Art. GB100.03

Set 2 palette  
Front and Back con 2 palle  
Front and Back set

pg.42



Art. F4JR026  
Pattino in line  
allungabile Junior  
Taglie: 30/33 - 34/37 - 38/41  
In line skate adjustable size



pg.54



Art. ML8125  
Monopattino  
pieghevole,  
ruote Ø mm. 125  
peso massimo  
utilizzatore kg. 50  
Junior Scooter



Art. ML9200  
Monopattino  
pieghevole,  
ruote Ø mm. 200  
peso massimo  
utilizzatore kg. 100  
Scooter



Art. FRPPR  
Frisbee  
diametro cm. 27,5 - gr.160  
Frisbee

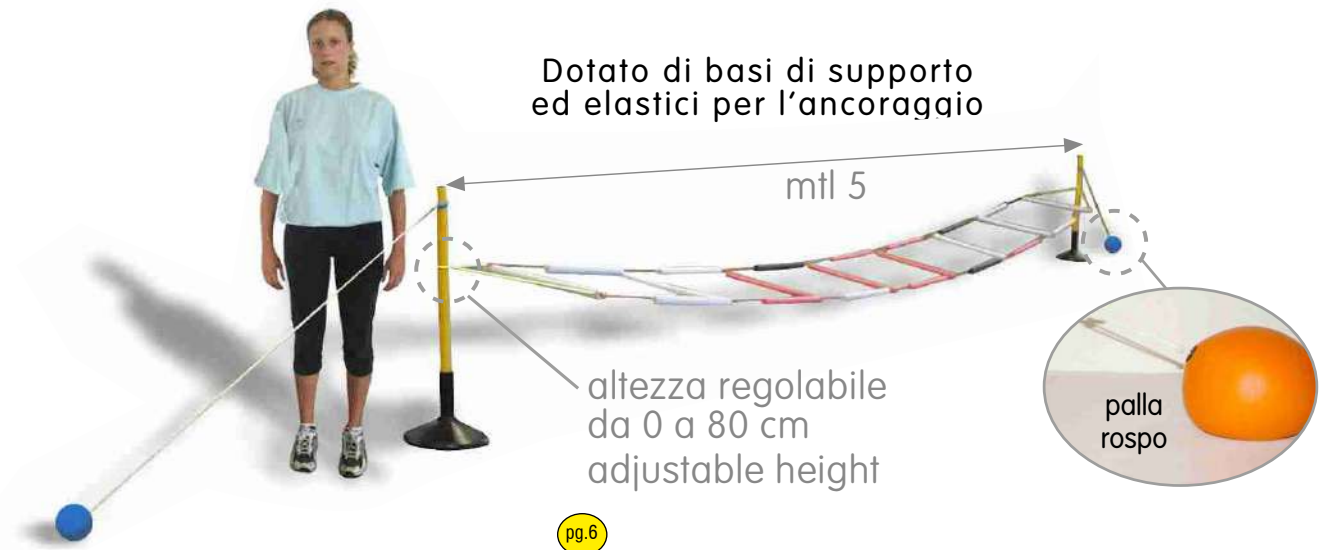

**Art. T10076**  
**Coordinatore di Frequenza / Calcio Tennis**  
**lunghezza m. 5 utilizzabile anche su superfici sintetiche**  
**attrezzo sicuro, privo di picchetti in metallo**  
Speed Ladder / Soccer Tennis Kit  
length 5 meters - also for indoor or artificial grass  
safe without any metal spikes

**Ideale per i bambini delle scuole calcio**  
**best for soccer school kids**



pg.6

**Art. T10075**  
**Attrezzo per slalom e tiri di precisione**  
**lunghezza mt.7,32 - altezza mt.1,80**  
**utilizzabile anche su erba sintetica o indoor**  
**attrezzo sicuro, privo di picchetti in metallo**  
Slalom and shooting training device  
length 7,32 mt. - height 1,80 mt.  
also for artificial grass or indoor  
safe without metal pegs







# BARRET®

ATTREZZATURE PER L'ALLENAMENTO DEI CAMPIONI  
TRAINING TOOLS FOR CHAMPIONS

## BARRET SRL

Via Marie Curie, 6/8  
Zona Ind.le S. Pietro in Palazzi  
57023 Cecina (LI) - Italy  
tel. (+39) 0586 661215  
fax (+39) 0586 662417  
info@barretsport.com  
www.barretsport.com

